

**CONSTRUCTION-BASED APPROACHES TO
FLEXIBLE WORD ORDER**

by

Andrew Charles Wetta

December 11, 2014

A dissertation submitted to the
Faculty of the Graduate School of
the University at Buffalo, State University of New York
in partial fulfillment of the requirements for the
degree of

Doctor of Philosophy

Department of Linguistics

Acknowledgements

I would like to thank my advisor, Rui Chaves, who has provided me with continued support throughout the dissertation process. He fueled my early ideas, encouraged their development, and challenged the results. Without his guidance, I surely would not have made it this far. I would also like to thank my other committee members, Jean-Pierre Koenig and Matthew Dryer. I benefited greatly over the years from their courses and advice, which have shaped many of my ideas here. Additionally, I would like to thank Jeff Good, who initially got me interested in word order and supported my initial work.

Finally, I would like to thank my family and friends for providing encouragement as well as welcomed distractions. Ashlee, I could not have done this without you.

Contents

Acknowledgements	i
List of Figures	vii
Abstract	ix
Abbreviations	x
1 Introduction	1
1.1 Main Contributions and Claims	3
1.2 Outline	3
2 Flexible and Verb Second Word Order	5
2.1 Verb Second Clauses	8
2.1.1 Declarative Main Clauses	9
2.1.2 Question Clauses	11
2.1.3 Subordinate Clauses	12
2.2 Clause Type Asymmetries	14
2.2.1 Subordinate Clause Asymmetries	14
2.2.2 Other Asymmetries	17
2.3 First Position Elements	18
2.4 Multiple First Elements	21
2.5 Verbal Elements	23
2.6 Summary	27

3	Frameworks and Previous Accounts	30
3.1	Transformational Accounts	33
3.2	Structure Modification or Direct Licensing?	35
3.3	A Constraint-based Approach	40
3.4	Extraction-based Accounts for V2	46
3.4.1	Verb Inversion	47
3.4.2	Verb Traces	49
3.5	Liberation and Domain-based Accounts	56
3.5.1	Topological Fields	58
3.5.2	German Constructions	62
3.5.3	Topological Fields in Other Languages	65
3.6	The Role of the First Position	67
3.6.1	Information Structure	69
3.6.2	Linear Phenomena	70
3.6.3	Bounded Extraction	72
3.7	Putative Evidence for V2 via Extraction	74
3.7.1	Wh-Interrogatives	74
3.7.1.1	Yiddish wh-interrogatives	76
3.7.1.2	Local wh-interrogatives	77
3.7.2	Discontinuous NPs	79
3.8	Summary	81
4	Cross-linguistic Word Order Domains	84
4.1	Topological Fields Revisited	85
4.2	Generalized Mechanisms	87
4.2.1	Two-typed Domain Elements	87
4.2.2	Domain Compaction	89
4.2.3	Cross-linguistic Constructions	90
4.3	Language-specific clause licensing	92

4.3.1	German	94
4.3.1.1	Verb Second	94
4.3.1.2	Partial Verb Phrase	97
4.3.1.3	Verb Third	97
4.3.1.4	Verb Final	100
4.3.1.5	Topicalization	100
4.3.2	Breton	102
4.3.2.1	Verb Second	102
4.3.2.2	Verb Initial	103
4.3.3	Kashmiri	104
4.4	Summary	106
5	Flat Constructions	108
5.1	Evidence for Flatter Structure	109
5.1.1	Implausible Binary Branching Structures	111
5.1.1.1	Learnability	112
5.1.1.2	Right Branching	113
5.1.1.3	Left Branching	114
5.1.1.4	Nominal Complements and Modifiers	117
5.1.1.5	Complex Predicates	119
5.1.1.6	Summary	122
5.1.2	Cross-linguistic Branching Tendencies	123
5.1.3	Summary	125
5.2	Interacting Linear and Predicate Constructions	126
5.3	Formal Preliminaries	130
5.4	V2 Clauses	135
5.4.1	Single Predicate	136
5.4.2	Multiple Predicates	142
5.4.3	Interim Summary	150

5.4.4	Partial Verb Phrases	152
5.4.4.1	Split Non-finite Verbal Elements	155
5.4.4.2	Subject Agreement with Fronted Phrase	158
5.4.5	Adjuncts	160
5.4.5.1	Constructional Approach	161
5.4.5.2	Lexical Approach	165
5.4.5.3	Semantic Scope	167
5.4.6	Verb Third	168
5.4.7	Content Questions	172
5.4.8	Coordination	176
5.4.8.1	Partially Saturated Phrases	178
5.4.8.2	Ellipsis	179
5.4.9	Summary	184
5.5	Other Linear Orders	187
5.5.1	Verb Initial	187
5.5.2	Verb Final	189
5.5.3	Summary	191
5.6	Subordinate Clauses	191
5.6.1	Complement Clauses	191
5.6.2	Relative Clauses	195
5.6.3	Non-finite Clauses	198
5.7	Extraction	202
5.8	Summary	208
6	Conclusion	211
A	Grammar for Flat Analysis of German	214
A.1	Type Hierarchies	214
A.2	Type Declarations	215

A.3 Constructions	216
References	223

List of Figures

2.1	Verb placement in various clause types.	29
3.1	Analysis of main declarative German clause in GB.	35
3.2	Analysis of interrogative German clause in GB.	36
3.3	Sample type hierarchy in a constraint-based grammar.	41
3.4	Tree representation of the SUBJECT-PREDICATE CONSTRUCTION.	43
3.5	Sample fully licensed construction.	44
3.6	Sample construction hierarchy of lexemes.	45
3.7	Example using the FILLER-HEAD CONSTRUCTION.	47
3.8	Analysis of German V2 clause with verb trace.	52
3.9	Extraction used to license a verb third German clause.	55
3.10	German topological fields.	59
3.11	HEAD-ARGUMENT SCHEMA with topological domains.	62
3.12	HEAD-FILLER SCHEMA with topological domains.	63
3.13	Hierarchy of clausal constraints for German	64
3.14	FILLER-HEAD CONSTRUCTIONS with unknown placement of a V2 CONSTRUCTION.	73
4.1	German topological fields.	85
4.2	Hierarchy of clausal constraints common to all V2 languages.	90
4.3	Partial hierarchy of phrasal constructs for V2 languages.	93
4.4	Partial hierarchy of clausal constructs for German.	94
4.5	Clause structure for German V2 sentence.	96
4.6	A construct showing compaction of a partial verb phrase in German.	98

4.7	Clause structure for German V3 sentence.	99
4.8	Clause structure for German sentence with topicalized element.	101
4.9	Partial hierarchy of clausal constructs for Breton.	102
4.10	A construct showing compaction of verbs in Breton.	104
4.11	Partial hierarchy of clausal constructs for Kashmiri	105
5.1	A visual array with recursion.	112
5.2	Putative structure of NP with nominal complement and modifier.	117
5.3	Possible structures of French VP with auxiliary verb.	120
5.4	Examples of CRDs.	124
5.5	Sample hierarchy of combined linear and predicate constructions.	130
5.6	Partial hierarchy of <i>linguistic objects</i>	131
5.7	Initial partial type hierarchy of V2 constructions.	140
5.8	Flat syntactic structure for the single predicate V2 sentence in (223).	141
5.9	Clause structure of multiple predicates <i>without</i> argument composition.	143
5.10	Type hierarchy of verb forms.	145
5.11	Flat syntactic structure for the multiple predicate V2 sentence in (230).	149
5.12	Expanded partial type hierarchy of V2 constructions.	150
5.13	Binary branching structure of fronted partial verb phrase with subject.	159
5.14	Binary branching structure with adjunct construction.	163
5.15	Flat structure with adjunct construction.	163
5.16	Flat structure with LEXICAL-MODIFIER CONSTRUCTION.	166
5.17	Type hierarchy of flat constructions used to license V2(-like) declarative clauses in German.	186
5.18	Full type hierarchy of LINEAR CONSTRUCTIONS.	191
5.19	Type hierarchy of linear markings.	193
5.20	Type hierarchy of verb forms.	200

Abstract

This dissertation investigates surface-oriented, construction-based approaches to flexible and verb second (V2) word order. Generally, syntactic structure is analyzed as binary branching structures, which often form complex embedded phrases. Such analyses are problematic for flexible word order which allows many alternate yet equally valid linearizations of elements. Positional constraints like V2, where the finite verb is required to appear in the second position, contribute further difficulties. Often extraction processes and complex mechanisms are required to account for these properties. This dissertation argues against this type of underlying structure which cannot be empirically detected. Instead, linguistic evidence suggests that syntactic structure is flatter than usually assumed. Phenomena that were previously attributed to the form of underlying structure are readily seen in surface structure or better described by non-syntactic processes. The word order properties of six V2 languages including Breton, German, Ingush, Kashmiri, Karitiána, and Yiddish are explored, and it is shown that simple linearization constructions appropriately license flexible word order across languages in a surface-oriented manner, and that extraction is not the appropriate way to derive V2 order.

Furthermore, having argued against the use of unobservable underlying structures and mechanisms, this dissertation provides an extensive analysis of German clause structure with flat constructions. It is proposed that a clause with flexible word order and other positional constraints is licensed by the combination of two general classes of constructions: those which license the linear placement of elements and those which license argument saturation. These constructions capture observable patterns at the clause level and underspecify the positions of flexible elements. This flatter approach to flexible word order and V2 is not only more consistent with observable data but also accounts for problematic phenomena in other approaches.

Abbreviations

1	first person	M	masculine
2	second person	NEG	negative
3	third person	NFUT	non-future
ACC	accusative	NOM	nominative
AUX	auxiliary	NW	non-witnessed past
B	gender category	OBL	oblique
CAUS	causative	OFC	object focus construction
CONJ	conjunction	PFV	perfective
COP	copula	PL	plural
CVB	converb	POS	possessive
D	gender category	PROG	progressive
DAT	dative	PRS	present
ERG	ergative	PRT	particle
EXCL	exclusive	PST	past
F	feminine	PTCP	participle
FUT	future	Q	question marker
GEN	genitive	REL	relativizer
INCL	inclusive	SG	singular
INF	infinitive	SIM	simultaneous
IPFV	imperfective	V	gender category
J	gender category	WP	witnessed past

Chapter 1

Introduction

Flexible word order is problematic for syntactic theories, especially those which posit embedded hierarchical relations among syntactic elements or specific phrasal groupings. Positional constraints like verb second (V2) word order, such as those attested in Germanic languages, contribute further difficulties. Many of these difficulties are a result of the competing goals of argument saturation and word order constraints. Often formal syntactic theories are rooted in the analysis of English grammar, whose syntax is less flexible and whose linear order is relatively strict. These English-oriented theories are highly compatible with binary structures, as particular elements nearly always combine in the same way. For instance, in a typical analysis of an English sentence with a transitive verb, the verb combines with the direct object, and then the subject combines with this verb phrase. However, this type of embedded structure is complicated by flexible word order in other languages. The inability to incorporate flexible word order into traditional phrase structure rules led to an approach to grammar, originating with Curry (1961), where rules are split along *tecto* and *phenogrammatical* dimensions of syntax. Roughly, the tectogrammar describes which elements may combine to form new units irrespective of order (e.g. a verb and its object combine to create a verb phrase) while the phenogrammar describes the order of elements (e.g. the verb appears before the direct object). This type of approach was continued by Dowty (1996), Reape (1994, 1996) with *word order domains*, and Kathol (2000) with a construction-based analysis of German, which is a flexible word order language. These approaches, generally called linearization-based approaches, assume standard nested constituency structure but resort to an independent level of word order which has its own mechanisms and processes.

However, linguistic evidence indicates that syntactic structure is flatter and reflects observable patterns. For instance, Culicover and Jackendoff (2005) show that binding phenomena are not accurately described by the configuration of embedded structures but instead by surface order. Similarly, Frey (1993) and subsequently Kathol (2000) demonstrate that quantifier scope in German is determined by linear order and not structural configurations. Furthermore, Dryer (2008) argues that what were previously considered cross-linguistic syntactic branching patterns are actually semantic patterns, while others are a result of cognitive processing constraints. In general, phenomena previously attributed to the form of underlying syntactic structures are readily seen in surface structure or better described by non-syntactic processes. Thus, linguistic evidence is often only compatible with flat structures. Such structures require a grammar of flat rules which directly license complete clauses. While flat rules are more complex than the branching variants and thus often left unexplored, they do not require an unobservable tectogrammatical dimension like with word order domains, covert extraction operations, or traces. In fact, I show that extraction does not accurately account for flexible word order.

In this dissertation, I explore construction-based analyses of flexible word order which characterize observable structures with a generalizable set of flat constructions. I begin by examining the cross-linguistic properties of flexible word order as well as its interaction with positional constraints like V2. I subsequently explore two related approaches within constraint-based grammar, particularly for German. The first approach expands on the constructional linearization domain account proposed by Kathol (2000) and provides a common construction-based linearization theory of word order for several languages. The result is an approach to word order which shows that flexible word order languages share basic surface-oriented properties. Yet, this domain-based approach remains agnostic to the type of underlying structure. Second, building on my preliminary analysis, I develop a theory of flatter syntax which only posits structures that may be plausibly detected from direct evidence. This theory removes a word order domain level of grammar and provides a general method for encoding both linear order as well as predicate saturation directly into flat constructions.

Thus, I advocate an approach to syntax which directly encodes all potential and observable

word order patterns and reduces syntactic structure to its most basic and necessary form. This often results in flatter structure without the need to resort to more complex machinery.

1.1 Main Contributions and Claims

This dissertation details the cross-linguistic properties of verb second placement and its interaction with flexible word order as well as provides novel construction-based accounts of these observations and thus makes the following main contributions and claims:

- Surface-based accounts of linearization phenomena in V2 languages are both possible and plausible. These accounts do not require unobservable mechanisms like linearization domains, parameters, or extraction (modeled as movement in some theories).
- V2 word order and flexible word order are not the result of some extraction process, that is, the first element of a V2 clause is not the result of a long-distance dependency.
- Clausal constructions can describe both the linear and combinatorial structure of flexible word order. These constructions reflect a relatively flat phrase structure and can accurately license all utterances.
- A detailed syntactic analysis of German is explored and demonstrates that a flat construction-based approach succinctly licenses a wide range of clause structures, including V2 and flexible word order.

1.2 Outline

Chapter 2 A descriptive overview of six relatively genealogically diverse V2 languages is provided for Breton, German, Ingush, Kashmiri, Karitiâna, and Yiddish. Verb placement and first position elements, which are central to the description of V2, are examined for main, subordinate, and question clauses. This examination shows that V2 order behaves similarly for all languages, and that any particular clause type for a language generally licenses a single standard word order. Thus, word order patterns are conditioned by clause types.

Chapter 3 Syntactic analyses of flexible word order and V2 utilize various frameworks which range from the direct encoding of surface elements to heavy modification of underlying abstract structures. The use of extraction to model flexible word order is critically examined. Such extraction analyses sometimes posit unobservable and untestable features and mechanisms to account for syntactic structure. I argue that this complex structure is not plausible.

Chapter 4 Adopting a general linearization domain-based approach to flexible word order, I show that the cross-linguistically observed word order patterns of V2 languages may be formalized with the same set of mechanisms and without extraction. These common mechanisms encode observable linearization patterns, like V2, while allowing for flexible word order. In this construction-based account, inspired by Kathol (2000), word order is constructionally specified via a special linearization $DOM(AIN)$ feature which encodes word order. Generally, the structures specified in DOM are much flatter than the corresponding syntactic constituents. I provide examples of licensed clauses for German, Breton, and Kashmiri.

Chapter 5 Going one step further, I show that the empirical evidence suggests that the syntactic constituency is flatter than usually assumed, and that there is no need for linearization mechanisms like DOM . Instead, I provide a surface-oriented account of German word order that postulates the least amount of unobservable mechanisms possible, and is directly motivated by the observable facts. I provide an extensive analysis of German syntactic structure which posits flat constructions to license both combinatorial and linear properties. This analysis, which does not utilize extraction or linearization domains, demonstrates the ability of surface-based constructions to appropriately license a wide variety of flexible word order clauses including V2, fronted partial verb phrases, and verb third as well as handle subordinate clauses, semantic scope of modifiers, and other verb placements.

Chapter 2

Flexible and Verb Second Word Order

Languages like English are fairly consistent in the linear placement of predicates and their arguments. This consistency lends itself to characterizations which define the relative placement of the verb, subject, and object in a single clause such that English, for instance, is considered an SVO language. The linearization of these elements in strict or inflexible word order languages, like English, often only deviates from the canonical order in particular constructions or special discourse contexts: For instance, an object may appear before the subject in topicalization and cleft constructions, the verb can precede the subject in subject-auxiliary constructions, or certain adnominal phrases can be extraposed.

However, the linearization of elements becomes much more complex in languages which have more flexible word order placement. So-called “free” word order languages allow many alternate and equally acceptable orderings of predicates and their arguments. The lax constraints of word order are most visible and famous in Australian languages, like Warlpiri, which not only allow seemingly free word ordering of constituents but also radically discontinuous phrases (Hale, 1983; Nordlinger, 1998). For example, consider the sentences in (1), which are grammatical variants of each other. The second variant contains a discontinuous noun phrase where the adjective *wiri* ‘big’ is separated from the noun *maliki* ‘dog’ which it modifies. Similarly, the second variant of the sentences in (2) is a complete reshuffling of the elements from the first variant but still attests a valid linearization. While discontinuous constituents are not unique to Warlpiri, their distribution is most striking in this Australian language.

- (1) a. Maliki wiri-ngki \emptyset -ji yarlku-rnu
 dog big-ERG PERF-1SG.OBJ bite-PST
- b. Maliki-rli \emptyset -ji yarlku-rnu wiri-ngki
 dog-ERG PERF-1SG.OBJ bite-PST big-ERG
 ‘A big dog bit me.’ *Warlpiri* (Hale, 1994, 189)
- (2) a. Pirli-ngka kankarlumparra ka ya-ni pintapinta
 mountain-LOC over PRES go-NPST airplane
- b. Pintapinta ka kankarlumparra ya-ni pirli-ngka
 ‘The airplane is going over the mountain.’ *Warlpiri* (Hale, 1994, 190)

Russian also exhibits a high degree of flexible word order as shown in (3). Here, an utterance comprised of a subject, verb, and object, can appear in all six logical orders. The semantics of each sentence is maintained with each permutation. However, King (1993) attributes these various permutations to positionally marked discourse functions, that is, there are discourse-pragmatic constraints on the order of elements, but all linearization options remain syntactically valid. Such word order, therefore, cannot be labeled *free*, as the Warlpiri examples may suggest, rather, the word order is only *flexible* and is still sensitive to non-syntactic constraints like pragmatics and information structure. Furthermore, other languages which possess a high degree of flexibility, such as Finnish, Hindi, and Korean, also exhibit some constraints on word order.

- (3) a. Ivan kupil knigu
 Ivan.NOM buy.PST.3SG book.ACC
- b. Ivan knigu kupil
- c. Knigu Ivan kupil
- d. Knigu kupil Ivan
- e. Kupil Ivan knigu
- f. Kupil knigu Ivan
- ‘Ivan bought the/a book’ (van Gelderen, 2003, 35)

However, sometimes these constraints on flexible word order are in fact syntactic, such as in the case of verb second (V2) word order. For instance, German also possesses a high degree of

flexibility as depicted in (4) but it also has a V2 ordering constraint. This additional constraint dictates that the finite verb appear in the second position immediately after a single constituent, and may not be displaced like the other clausal elements. In all the variants of the sentences in (4), the finite verb, shown in boldface to aid in its identification, always appears after a single constituent while all other elements may flexibly shuffle throughout the clause. Naturally there are often pragmatic factors which constrain the order, but syntactically many linearizations are permissible.

- (4) a. Peter **wollte** dem Jungen das Buch schenken.
 Peter want.PST.3SG the.DAT boy.DAT the.ACC book give.INF
 b. Dem Jungen **wollte** Peter das Buch schenken.
 c. Das Buch **wollte** Peter dem Jungen schenken.
 d. Schenken **wollte** Peter dem Jungen das Buch.

‘Peter wanted to give the book to the boy.’ *German* (Uszkoreit, 1987, 156)

Thus, as demonstrated here, the second position is not defined by the individual word positions, rather by the positions of constituents, which may consist of any number of words. Consider the sentence in (5) with a multi-word first element, *schon sehr lange* ‘already very long’, preceding the finite verb of the clause. Because this first element forms a single constituent, it only occupies a single ordering position, namely the first, and the finite verb then occupies the second position. Similarly, in (6) an entire subordinate clause, but nonetheless a single constituent, appears in the first position.

- (5) [Schon sehr lange] **wartet** Otto auf den Bus
 already very long wait.PRS.3SG Otto on the.ACC bus
 ‘Otto has already been waiting a long time for the bus.’ *German* (Dudenredaktion, 2005, 875)
- (6) [Weil er warten musste,] **war** er nicht pünktlich gekommen.
 because he wait.INF must.PST.3SG was.PST.3SG he not on.time come.PTCP
 ‘Because he had to wait he did not come on time.’ *German* (Uszkoreit, 1987, 25)

Furthermore, discontinuous constituents are also possible in German, much like English, such as the split noun phrase in (7), which attests to the flexibility of word placement.

- (7) [Ein Buch] **hat** er sich über *Syntax* ausgeliehen.
 a book have.PRS.3SG he himself about syntax borrow.PST.PTCP
 ‘He borrowed a book about syntax.’ *German* (De Kuthy, 2002, 5,7)

Because V2 languages exhibit word order flexibility, a strict positional constraint on the finite verb, and a degree of discontinuity, they provide ideal subjects for an investigation of flexible word order and its syntactic constraints, which is the main focus of this dissertation. In the next sections I provide a typological and descriptive overview of the linearization phenomena in V2 languages which will be further analyzed in the remaining chapters of the dissertation.

2.1 Verb Second Clauses

Following the definition of Anderson (2005, 179), a V2 clause is characterized by the verb with tense, mood, and agreement properties (i. e. the finite verb) appearing in the second position immediately after one constituent. Although this V2 phenomenon is most cited with Germanic languages, such as Danish, Dutch, German, Icelandic, and Yiddish, among others, it also occurs in other non-Germanic languages, such as Breton (Celtic), Ingush (Nakh-Daghestanian), Karitiâna (Tupian), Kashmiri (Indic), and Romansch (Romance), showing that it is a phenomenon which occurs in many language families.

From these languages attesting V2 word ordering, a subset has been chosen for a word order typology, presented in this chapter, in order to gain a descriptive understanding of the phenomenon. While this may not completely represent typological variation, it presents a sufficiently broad description of the verb second phenomenon and its range of realizations in order to later develop a foundation for a cross-linguistic analysis. The sample presented in this chapter includes Breton, German, Ingush, Kashmiri, Karitiâna, and Yiddish. These six languages were chosen because they each belong to a different language sub-family, with the exception of German and Yiddish. However, these two Germanic languages exhibit different word ordering behaviors and both warrant inclusion into the typology so as to provide a broader characterization of the V2 phenomena. Additionally, this sampling was, in part, chosen due to the availability of data and sufficiently descriptive grammars and, as such, represents a convenience sampling. I explore the types of V2

clauses in these six languages in the following sections.

2.1.1 Declarative Main Clauses

Typical V2 clauses are illustrated by the examples in (8)–(13), where the finite verb appears in the second position of the clause.

- (8) Mona **a zebr** he boued er gegin.
 Mona PRT eat.3SG her food in.the kitchen
 ‘Mona eats her food in the kitchen’ *Breton* (Press, 1986, 197)
- (9) Otto **hat** schon sehr lange auf den Bus gewartet.
 Otto have.3SG already very long on the bus wait.PST.PTCP
 ‘Otto has already waited a long time on the bus.’ *German* (Dudenredaktion, 2005, 875)
- (10) Cuo **diicar** suona jerazh.
 3SG.ERG D.tell.WP 1SG.DAT 3PL
 ‘She told them [=stories] to me.’ *Ingush* (Nichols, 2009)
- (11) Kitaab **dits** laRkan kooryi.
 book.NOM.SG.F give.PST.SG.F boy.ERG girl.DAT
 ‘The boy gave a book to the girl.’ *Kashmiri* (Bhatt, 1999, 71)
- (12) Õhëy **taka-’y-t** ta’a saryt Isoason.
 Õhëy PRT-eat-PST long.ago hearsay Isoason
 ‘Isoason ate Õhëy long ago.’ *Karitiâna* (Landin, 1982, 4)
- (13) Mir **hobn** geefnt doss fentster.
 we have.3PL open.PST.PTCP the window
 ‘We opened the window.’ *Yiddish* (Weissberg, 1988, 152)

Looking at some of these examples it is initially unclear how the V2 word order is any different than SVO. That is, most of these sentences begin with the subject, are followed by the finite verb, then followed by the object and any remaining elements. However, the effect of a positionally specified finite verb becomes apparent in variations of these sentences where the subject and objects appear in other places. Each of the six languages show some degree of flexible word order and allow various types of elements to be placed before the finite verb, yet always exactly one.

Illustrating the strict placement of the finite verb in the second position, the examples in (14)–(17) present alternative word orderings of some of the previous sentences in (8)–(13). In each of these alternate sentences, the subject is not the first element. Rather, some other constituent has taken the first position of the clause and the subject has been realized after the finite verb. The finite verb remains in the second position of the clause despite this reordering, thus demonstrating the signature property of verb second word ordering.

- (14) He boued **e tebr** Mona er gegin.
her food PRT eat.3SG Mona in.the kitchen
'Mona eats her food in the kitchen.' *Breton* (Press, 1986, 197)
- (15) Auf den Bus **hat** Otto schon sehr lange gewartet.
on the bus have.3SG Otto already very long wait.PST.PTCP
'Otto has already waited a long time on the bus.' *German* (Dudenredaktion, 2005, 875)
- (16) Raath **dits** laRkan kooryi kitaab.
yesterday give.PST.SG.F boy.ERG girl.DAT book.NOM.SG.F
'Yesterday the boy gave a book to the girl.' *Kashmiri* (Bhatt, 1999, 71)
- (17) A telegram **darf** men shraybn kurts un sharf.
a telegram must.3SG one write.INF short and sharp
'A telegram you have to write short and to the point.' *Yiddish* (Jacobs et al., 1994, 410)

What type of constituent may be placed before the verb and its nature will be briefly discussed in §2.3, but this first position may be occupied by any single constituent, regardless of how complex it is. For instance, an entire subordinate clause may appear first before the finite verb as shown in (18).

- (18) [Boroja taso oky tykiri] **Ø-naka-hyryp-Ø** õwã.
snake man kill PFV 3-PRT-cry-NFUT child
'When the man killed the snake, the child cried.' *Karitiâna* (Storto, 2003, 414)

As these previous examples show, all of these languages' affirmative declarative main clauses exhibit V2 word order, and it is this type of clause which most often characterizes the word order of a language. However, other types of clauses do not always have V2 word order. Changing the polarity of the clause, for example, with the addition of a negation word or affix can affect the

word order. Only four of the examined languages retain the verb second word ordering, namely German, Ingush, Kashmiri, and Yiddish as shown in (19)–(22). Non-V2 negative clauses for the other two languages will be discussed in §2.2.2.

- (19) Anna **will** das Buch nicht lesen.
 Anna want.PRS.3SG the book not read.INF
 ‘Anna doesn’t want to read the book.’ *German* (Dudenredaktion, 2005, 925)
- (20) Ghalghaai mott **dika-xaac** cynna.
 Ingush language well-know.NEG 3SG.DAT
 ‘She doesn’t know Ingush very well.’ *Ingush* (Nichols, 2009)
- (21) B† **chu-s-n†** azkal gar† gatsha:n.
 I be-1SG.PRS-NEG nowadays home go.PRS.PTCP
 ‘I don’t go home nowadays.’ *Kashmiri* (Wali and Koul, 1997, 113)
- (22) Si **hot** nisht gekont kejn pojlish.
 she have.3SG not can.PST.PTCP no Polish
 ‘She could not speak Polish.’ *Yiddish* (Weissberg, 1988, 174)

2.1.2 Question Clauses

Word order becomes more varied in non-declarative clauses, but V2 word order remains present in some of the languages for other clause types. Content questions (wh-questions in English) nearly uniformly position the finite verb in the second position. For the most part, the question word appears as the first element in the clause followed by the verb as shown in (23)–(27). In each question, the finite verb appears in the second position directly after a question word.

- (23) Piv **en** **deus** prenet an ti ruz?
 who 3SG.M have.PRS.3 buy.PST.PTCP the house red?
 ‘Who has bought the red house?’ *Breton* (Stephens, 2002, 401)
- (24) Wer **wartet** auf den Bus?
 who wait.3SG on the bus
 ‘Who is waiting on the bus?’ *German* (Dudenredaktion, 2005, 876)
- (25) Fy **duuc** wa, mychaa **jeinii** hwuona c’ie mettig bwarjg?
 what say.PRS you.SG.ERG where I.see.NW.J you.SG.DAT red place eye
 ‘What do you think, have you ever seen an all-red place?’ *Ingush* (Nichols, 2009)

- (26) Mora **i-'y-j** ohy?
 who 3-eat-FUT potato
 ‘Who will eat potatoes?’ *Karitiâna* (Storto, 2003, 418)
- (27) Wi **ruft** men dem ort?
 how call.3SG one the place
 ‘What is the place called?’ *Yiddish* (Weissberg, 1988, 160)

Yes/no (i.e. polar) questions also show V2 word ordering in many of the languages. While each language may use a different method of question marking, the finite verb is still realized in the second position as illustrated in (28)–(31). For example, Kashmiri and Ingush append a question suffix to the verb to mark a polar question, while Breton uses rising intonation and Karitiâna employs an adverb.

- (28) Nebar **cha-a** seThaa garam?
 outside is.PRS-Q very hot
 ‘Is it very hot outside?’ *Kashmiri* (Bhatt, 1999, 120)
- (29) Xii **mol=ii** wa?
 water drink=Q 2SG.ERG
 ‘Would you like a drink of water?’ *Ingush* (Nichols, 2009)
- (30) O tont **out**?
 PROG come.INF be.PRS.2SG
 ‘Are you coming?’ *Breton* (Stephens, 2002, 403)
- (31) a. Ñn **i-oky-t** sojja hÿ?
 you it-kill-PST pig Q.POS
 ‘Did you kill the pig?’
 b. Ñn **i-oky-j** kymĩnĩ sojja?
 you it-kill-FUT Q.NEG pig
 ‘Won’t you kill the pig?’ *Karitiâna* (Landin, 1984, 14)

2.1.3 Subordinate Clauses

Additionally, verb second word ordering is not restricted to main clauses but may also be realized in subordinate clauses. Content clauses, in contrast to relative clauses, are distinguished by the

lack of a relativized or gapped element. And despite being subordinate, content clauses contain the same material as a main clause (Huddleston, 1999). Yet, only some V2 languages maintain the second position of the finite verb in content subordinate clauses, namely Yiddish and Kashmiri, as in (32)–(33).

- (32) Ikh hob gezen mitvokh, [as ikh **vel** nit kenen kumen
I have.1SG see.PST.PTCP Wednesday that I will.1SG not can.INF come.INF
donershtik].
Thursday
'I saw on Wednesday that I wouldn't be able to come on Thursday.' *Yiddish* (Jacobs et al., 1994, 410)
- (33) Tem-is chu afsos [ki yi kitaab **cha-yi** tse
he-DAT be.3SG.M regret.PRS.PTCP that this book be.F-2SG you.F.SG.ERG
par-mets].
read-PST.PTCP
'He regrets the fact that it is this book that you have read.' *Kashmiri* (Bhatt, 1999, 100)

The V2 order of these content subordinate clauses mirrors that of the main clauses. When determining the position of an element in a subordinate clause, the subordinator is not included as occupying a word order position. This is a practice which I adopt so as to maximize the similarity and comparability between main and subordinate clauses. Often the only difference between a main and subordinate clause is the presence of a clause initial subordinator, with all other possible word order realizations remaining the same. So, in (32) the subordinator *as* does not occupy a word position, rather *ikh* begins the clause in regards to ordering in the first position. Besides the subordinators in these two languages, there are no apparent structural differences between these content clauses and main clauses.

In Yiddish, the verb second word order also persists in relative clauses like in (34). As with content subordinate clauses, the relativizer is not counted as one of the clausal positions.

- (34) di mayse, [vos ikh **vel** aykh dertseyln]
the story that I will.1SG you tell.INF
'the story that I'll tell you' *Yiddish* (Jacobs et al., 1994, 416)

In this section I have shown that despite the differences among these six languages, they all exhibit the same V2 word ordering to varying degrees across all clause types, with main affirmative clauses being V2 for all languages. In all of these attested V2 clauses, the finite verb appears directly after a single constituent. However, as alluded to in this section, there are non-V2 clause types in these V2 languages, which exhibit different finite verb placements. In the following sections, I explore these differences as well as other properties of V2 clauses.

2.2 Clause Type Asymmetries

Even though a language may attest V2 word order, it may not be applied to all clause types. That is, subordinate and question clauses, among others, may exhibit different finite verb placements than verb second positioning. For instance, German only exhibits V2 ordering in main clauses while subordinate clauses exhibit verb final placement. This asymmetry is explored by Bhatt (1999), among many others, whose analysis of word order in Kashmiri reviews the possible distributions of V2 clauses within a single language. Like German, some V2 languages exhibit this divide between main and subordinate clauses, often called *root-subordinate asymmetry*, including Breton, Dutch, Ingush, Norwegian, and Swedish, among others, which Bhatt calls A(symmetric)-V2 languages. Other V2 languages do not exhibit this division and attest V2 ordering in both main and subordinate clauses. Thus, these so-called S(ymmetric)-V2 languages include, among others, Yiddish, Icelandic, and Kashmiri.

2.2.1 Subordinate Clause Asymmetries

To exemplify this division between A-V2 and S-V2 languages consider (35)–(36). The first example from Breton shows the root-subordinate asymmetry. Sentence (35a) is a main clause which exhibits V2 word ordering, while sentence (35b) is a subordinate clause with non-V2 ordering, in this case, verb initial placement. The finite verb in Breton is always preceded by a particle (*a* or *e*) which is analyzed as part of the verb. The verb ‘to have’ in (35a) is unlike all other verbs in Breton in that it is not preceded by the usual particles. Instead the verb has a preposed object pronoun which is co-indexed with the subject (Press, 1986, 139). This obligatory pronoun is treated like a

particle and analyzed as part of the verb. The second example shows two sentences from Kashmiri, the first a main clause (36a) and the second a subordinate (36b). In both instances V2 word ordering is used and thus no asymmetry occurs.

- (35) a. Yann **en deus** debret e voued er wetur.
 Yann 3SG.M have.PRS.3 eat.PST.PTCP his food in.the car
 ‘Yann has eaten his food in the car’ *Breton* (Press, 1986, 200)
- b. Gwelout a reas Lenaig [**e save** an dour].
 see.INF PRT do.PST.3SG Lenaig PRT rise.PST.3SG the water
 ‘Lenaig saw the water was rising.’ *Breton* (Stephens, 2002, 399)
- (36) a. Akhbaar **por** laRkan raath.
 newspaper read boy yesterday
 ‘It was the newspaper that the boy read yesterday.’ *Kashmiri* (Bhatt, 1999, 137)
- b. Me buuz [ki akhbaar **por** raath laRkan].
 1SG hear that newspaper read yesterday boy
 ‘I heard that it was the newspaper that the boy read yesterday.’ *Kashmiri* (Bhatt, 1999, 138)

So, the placement of the finite verb is constrained by the clause type, giving rise to a root-subordinate asymmetry in some V2 languages. In §2.1, there were examples of languages which have V2 subordinate clauses like Yiddish and Kashmiri and consequently do not have a root-subordinate asymmetry. But the other four languages do not attest V2 word order in subordinate clauses. German and Ingush display a verb final word ordering as shown in (37)–(38).

- (37) Paul weiß, [dass Peter nach Hause **kommt**].
 Paul know.3SG that Peter to home come.3SG
 ‘Paul knows that Peter is coming home.’ *German* (Uszkoreit, 1987, 13)
- (38) [Jer kampjuutar hwal myshta **sog**] xoi hwuona?
 this computer up how turn.on know.PRS.Q you.SG.DAT
 ‘Do you know how to turn this computer on?’ *Ingush* (Nichols, 2009)

Karitiâna also attests verb final placement in content subordinate clause, but there is no agreement on the verb as shown in (39) (Storto, 2003, 413).

- (39) [Boroja taso **oky tykiri**] Ø-naka-hyryp-Ø òwã.
 snake man kill PFV 3-PRT-cry-NFUT child
 ‘When the man killed the snake, the child cried.’ *Karitiâna* (Storto, 2003, 414)

Finally, unlike the previous three languages, Breton displays a consistent verb initial word ordering for content subordinate clauses, which aligns with the standard verb initial word ordering of the other Celtic languages (Fife, 2002, 15). Example (40) illustrates this positioning.

- (40) Gwelout a reas Lenaig [e **save** an dour].
 see.INF PRT do.PST.3SG Lenaig PRT rise.PST.3SG the water
 ‘Lenaig saw the water was rising.’ *Breton* (Stephens, 2002, 399)

However, if the complementizers *ma* ‘if’ or *hag-en* ‘whether’ are present, then the subordinate clauses employ main clause word order as in (41) (Borsley and Kathol, 2000, 688). See §2.2.2 for an explanation of the negative subordinate clause in (41a).

- (41) a. Lom a deuiio endro [ma **ne gavan** ket anezhan].
 Lom PRT come.FUT return if NEG look.for.1SG NEG him
 ‘Lom will return if I don’t look for him.’ *Breton* (Borsley and Kathol, 2000, 689)
- b. N’ ouzon ket [ha lennet **en deus** Yann al levr].
 NEG know.1SG NEG whether read.INF 3SG.M have.PRS.3 Yann the book
 ‘I don’t know whether Yann has read the book.’ *Breton* (Borsley and Kathol, 2000, 689)

Languages which have this asymmetry for the content relative clauses also exhibit the same type of asymmetry for relative clauses. The finite verb in Breton is placed verb initially in relative clauses as illustrated in (42). This includes non-restrictive relative clauses which utilize a subordinator *hag* as in (43) (Stephens, 2002).

- (42) Setu an den [**a gontas** an istor dimp].
 here the man PRT tell.PST.3SG the story to.us
 ‘Here is the man who told us the story.’ *Breton* (Stephens, 2002, 400)
- (43) Ul levr [hag **a oan** o klask ...]
 a book CONJ PRT be.1SG.PST.IPFV PROG look.for.INF ...
 ‘The book I was looking for ...’ *Breton* (Stephens, 2002, 406)

German, Kashmiri, and Karitiâna attest verb final word order in relative clauses as illustrated by the sentences in (44)–(46). As with content subordinate clauses, there is no agreement on the verb in Karitiâna.

- (44) Paul kennt den Mann, [der zu spät **kommt**].
 Paul know.3SG the man who too late come.3SG
 ‘Paul knows the man who is late.’ *German* (Uszkoreit, 1987, 13)
- (45) Su naphar [yus me yo:r **on**] gav gar†.
 that person REL I.ERG here bring.PST.M.SG go.PST.M.SG home
 ‘The person whom I brought here went home.’ *Kashmiri* (Wali and Koul, 1997, 61)
- (46) Y-py-so’oot-on yn [sosy mynda ajxa **ti-oky**]=ty
 1SG-assert-NFUT I slowly armadillo you OFC-kill=OBL
 ‘I saw the armadillo you killed slowly.’ *Karitiâna* (Storto, 2003, 429)

It is unexpected that Kashmiri has non-V2 word order in relative clauses because it was shown in (36b) that Kashmiri content subordinate clauses have V2 word order. So, although there is no root-subordinate asymmetry in this language, there is, in fact, an asymmetry with relative clauses.

2.2.2 Other Asymmetries

In addition to subordinate clauses, there can be more asymmetries involving other clause types such as relative or question clauses. In §2.1, I showed that V2 word order is attested in all possible clause types across the six languages that are being examined. These same clause types, except for affirmative main clauses, also exhibit either verb initial or final placement for certain languages.

For instance, negative main clauses in Breton are verb initial, not V2. Breton allows various methods of ordering a negative main clause, but for a neutral, non-topicalized negative main clause, the negated finite verb appears in the initial position of the clause. As with affirmative clauses, negated finite verbs are always preceded by a particle *ne* but are also followed by the additional particle *ket* reminiscent of French verbal negation with *ne ... pas*. This first particle is analyzed as forming a single unit with the finite verb when determining word position in a clause to parallel the particle-verb structure in affirmative clauses. So, Breton has an asymmetry between affirmative and negative main clauses.

- (47) **Ne gavo** ket ho preudeur a labour e Pariz.
 NEG find.FUT NEG your brothers PRT work in Paris
 ‘Your brothers’ll not find any work in Paris’ *Breton* (Press, 1986, 198)
- (48) **N’ en deus** ket kollet Yann al levr.
 NEG 3SG.M have.PRS.3 NEG lost.PST.PTCP Yann the book
 ‘Yann has not lost the book.’ *Breton* (Stephens, 2002, 400)

Polar questions also provide for asymmetries in some languages. German is consistent in using verb initial word order to indicate a yes/no question as illustrated in (49).

- (49) **Musste** Otto lange auf den Bus warten?
 must.PST.3SG Otto long on the bus wait.INF
 ‘Did Otto have to wait a long time on the bus?’ *German* (Dudenredaktion, 2005, 876)

Like German, Yiddish also employs verb initial word order for yes/no questions as in (50), however, there exists an optional alternative. The question word *tsi* may be placed before the finite verb in the first position. This placement causes the clause to adopt verb second word ordering as shown in (51).

- (50) **Darf** men ergets sajn in goless?
 must.3SG one somewhere be.INF in exile
 ‘must one be somewhere in exile?’ *Yiddish* (Weissberg, 1988, 157)
- (51) **Tsi meg** men si nemen bajm hant?
 tsi may.3SG one her take.INF by hand
 ‘May one take her by the hand?’ *Yiddish* (Weissberg, 1988, 158)

2.3 First Position Elements

In a verb second clause, the finite verb must appear after exactly one constituent, and this first constituent may be of a variety of types, including verbal arguments, adjuncts, and non-finite verbs as I have shown in the previous sections. Flexibility in the linear realization of constituents, i.e. flexible word order, is predominately responsible for this variation of the first element. For example, German allows many permutations of constituents while maintaining the finite verb in the second position (Uszkoreit, 1987; Eisenberg, 1994; Dudenredaktion, 2005). Consider the various

permutations of the sentence in (4) repeated below in (52). Here the finite verb *wollte* ‘want’ remains stationary and all other elements may be flexibly positioned (with some language-dependent restrictions). Despite the ordering of the constituents, only one appears in the first position.

- (52) a. Peter **wollte** dem Jungen das Buch schenken.
 Peter want.PST.3SG the.DAT boy.DAT the.ACC book give.INF
 b. Dem Jungen **wollte** Peter das Buch schenken.
 c. Das Buch **wollte** Peter dem Jungen schenken.
 d. Schenken **wollte** Peter dem Jungen das Buch.

‘Peter wanted to give the book to the boy.’ *German* (Uszkoreit, 1987, 156)

There are often various factors that influence the order which is considered most appropriate for a particular context, often pragmatic in nature. Joutiteau (2010, 206) acknowledges this special function of the first position by indicating that the preverbal area before the finite verb in a second position clause involves some sort of “information packaging”. But she is careful to explain that information structure does not necessarily induce a V2 word ordering. Rather, it seems that the pragmatic nature of the first element and placement of the finite verb in the second position are orthogonal factors, which are further discussed in §3.6.

Each language usually attests a standard neutral word order which does not provide pragmatic prominence to any element. In Breton, the periphrastic *ober* ‘to do’ construction in (53) provides the most pragmatically neutral word order (Stephens, 2002, 400). This sentence appears to be VSO, which is consistent with the word order of other Celtic languages, because a group of verbal elements appears before the subject and object. However, its form is similar to the German sentence in (52d) which suggests that this order in Breton does not necessarily reflect the typical Celtic VSO ordering pattern. This periphrastic construction is just one possible realization of the constituents where other possibilities may not be VSO but are always V2.

- (53) Gwelout **a ra** Yann e vignonez.
 see.INF PRT do.PRS.3SG Yann his girlfriend
 ‘Yann sees his girlfriend.’ *Breton* (Press, 1986, 188)

In Yiddish, the subject, as in most other V2 languages, appears by default in the first position with no prominence (Jacobs et al., 1994, 414). All other elements placed in the first position receive some sort of topicalization effect, that is, the element is endowed with some sort of discourse or pragmatic prominence. Stephens (2002, 401) explains that in Breton this topicalization effect for the first element must not contain any ‘heavy emphasis’ and is not restricted to either a topic or focus. Additionally, the topicalization effect is influenced by language-specific neutral word ordering. For instance, an initial subject in Yiddish may have no pragmatic prominence, whereas an initial subject is prominent in Breton.

As previously discussed, almost any constituent of a verb second clause may appear in the first position. Consider the German sentences in examples (54)–(57). The first constituents in these clauses include the dative object of the verb, a prepositional phrase, a subordinate clause, and a past participle.

- (54) Den Kindern **schickte** Peter das Paket.
 the children send.PST.3SG Peter the parcel
 ‘Peter sent the children to the children.’ *German* (Uszkoreit, 1987, 25)
- (55) Auf die Waage **hatte** er das Paket gelegt.
 on the scale have.PST.3SG he the parcel put.PST.PTCP
 ‘He had put the parcel onto the scale.’ *German* (Uszkoreit, 1987, 25)
- (56) Weil er warten musste, **war** er nicht pünktlich gekommen.
 because he wait.INF must.PST.3SG be.PST.3SG he not on.time come.PST.PTCP
 ‘Because he had to wait he did not come on time.’ *German* (Uszkoreit, 1987, 25)
- (57) Abgeschickt **hatte** er das Paket.
 off.sent.PST.PTCP have.PST.3SG he the parcel
 ‘He had sent the parcel off.’ *German* (Uszkoreit, 1987, 26)

Similarly, the same diversity of elements may appear in the first position in Kashmiri. Consider examples (58)–(60). Here verbal arguments, a prepositional phrase, a non-finite verb, and even a partial verb phrase appear in the first position. Any constituent may be realized before the finite verb in Kashmiri (Wali and Koul, 1997), as with the other V2 languages.

- (58) a. Mi **dits** mohn-as yi kəmi:z ba:gas manz.
 I.ERG give.PST.SG Mohan-DAT this shirt garden in

- b. Yi kəmi:z **dits** me mohnas ba:gas manz.
this shirt give.PST.SG I.ERG mohan.DAT garden in
- c. Mohnas **dits** me yi kəmi:z ba:gas manz.
Mohan.DAT give.PST.SG I.ERG this shirt garden in
- d. Ba:gas manz **dits** me mohnas yi kəmi:z.
garden in give.PST.SG I.ERG mohan.DAT this shirt
'I gave this shirt to Mohan in the garden.' *Kashmiri* (Wali and Koul, 1997, 146)
- (59) Gyavaan **oos** su dohay jaan.
sing.PRS.PTCP be.PST.SG.M he everyday good
'It was singing that he always did a good job of.' *Kashmiri* (Bhatt, 1999, 93)
- (60) DodI cavaan **oos** su dohay waar-waar.
milk drink.PRS.PTCP be.PST.SG.M he daily slowly
'It was drinking milk that he always took a lot of time with.' *Kashmiri* (Bhatt, 1999, 94)

Ingush and Karitiâna also display this same flexibility of elements appearing in the first position as illustrated in (61)–(64).

- (61) Cy Iliezaa **xou** cogh duqa hama
DEM.OBL Ilex.DAT know 3SG.LAT much thing
'Ilez knows a lot about him.' *Ingush* (Nichols, 2009)
- (62) [Txo senna deaxkaad] **xoi** hwuona shynciga?
1.EXCL why D.come.PL.NW know.Q 2SG.DAT 2PL.CHEZ
'Do you know why we've come to visit you?' *Ingush* (Nichols, 2009)
- (63) I-tyt **y-taka-tar-i** i-ambi-p
3-with 1SG-PRT-go-FUT 3-house-to/in
'I will go to his house with him.' *Karitiâna* (Storto, 2003, 417)
- (64) atykit **nã-omyk** saryt isoason ta mēm okop
DEIXIS.CAUS PRT-be.ashamed hearsay Boason to come again
'Because of this Boason was ashamed to come back again.' *Karitiâna* (Landin, 1982, 7)

2.4 Multiple First Elements

While V2 clauses are characterized by the finite verb appearing after a single constituent, there are also attested cases of verb third (V3) word orderings where the finite verb appears after two

constituents. This type of word ordering has the same properties as V2, but only differs in the number of elements appearing in the pre-finite verb positions.

For instance, Kashmiri behaves slightly differently than the other five languages when forming content questions. The other V2 languages use V2 word order to form a content question with some interrogative word in the first position. Similarly, Kashmiri places a question word directly before the finite verb, however, an additional element may appear before both of these elements in the first position. Thus, the finite verb appears in the third position of content question clauses. This additional element may be a subject or topic and produces a preferred V3 word order (Wali and Koul, 1997, 10) as shown in (65). In this example the question word *kyaa* appears before the finite verb *dyutnay*, but the element *raath* appears before both of these items.

- (65) raath kyaa **dyut-na-y** rameshan tse
 yesterday what.NOM give.PST.M.SG-3SG.ERG-2SG.DAT Ramesh.ERG you.DAT
 ‘As for yesterday, what is it that Ramesh gave you?’ *Kashmiri* (Bhatt, 1999, 107)

As previously shown in §2.1.1, the affirmative main clauses exhibits V2 word ordering in all the sampled languages. However, in some more restrictive and infrequent instances these languages allow a similar V3 word order as illustrated by Ingush, Karitiâna, and Yiddish in (66)–(68).

- (66) [Jurta jistie] [joaqa sag] **ull** cymogazh jolazh.
 town.GEN nearby J.old person lie.PRS sick.CVB.SIM J.PROG.CVB.SIM
 ‘In the next town an old woman is sick (is lying sick).’ *Ingush* (Nichols, 2009)
- (67) Mynda taso **na-m-potpora-j** ese.
 slowly man PRT-CAUS-boil-FUT water
 ‘The man boiled the water slowly.’ *Karitiâna* (Storto, 2003, 422)
- (68) Mamesh er **tsitert** far frajd.
 actually he shake.3SG with joy
 ‘He is actually shaking with joy.’ *Yiddish* (Weissberg, 1988, 155)

Weissberg (1988, 155) recognizes the sentence in (68) as belonging to a small set of restricted environments which allow V3 word order. However, he does concede that it may be difficult to determine if the two preceding elements before the finite verb should be analyzed as two constituents or one. Similarly, in Karitiâna an adverb may be placed before the subject as in (67) (Storto, 2003,

421). This V3 word order also appears in the Ingush sentence in (66). It is possible for both the topic constituent, *jurta jistie*, and the focus constituent, *joaqqa sag*, to appear before the finite verb consequently creating a verb third word order.

German also exhibits many cases of V3 word order as with the sentence in (69) where the finite verb appears in the third position after two initial constituents. The German example presents an alternative word order from the usual V2 for main clauses.

- (69) [Zum zweiten Mal] [die Weltmeisterschaft] **errang** Clark 1995.
 to.the second time the world.championship win.PST.3SG Clark 1995
 ‘Clark won the world championship for the second time in 1995.’ *German* (Beneš, 1971)
 quoted from (Müller, 2005b)

Müller (2003, 2005b) provides many examples of V3 word order which appear to fall into groupings which characterize the first two elements, like PP and NP for (69). However, these groupings do not appear to be completely productive and only occur in particular environments or expressions. Additionally, more elements could appear before the finite verb in even more restricted contexts to form word orders like V4 in (70).

- (70) [Immerhin] [gleich zwei Filme] [auf einmal] **drehte** 1989 der Regisseur Robert
 nevertheless even two movies at once film.3SG.PST 1989 the director Robert
 Zemeckis.
 Zemeckis
 ‘Nonetheless, the director Robert Zemeckis filmed two movies at the same time in 1989.’
German (Müller, 2003, 8)

2.5 Verbal Elements

Although the finite verb must appear in the second position of a V2 clause, the non-finite verbs are realized in many different locations. For instance, consider the German sentence in (71). The finite verb *hatte* ‘had’ appears in the appropriate second position, but the past participle *gesungen* ‘sang’ appears separate from the finite verb at the end of the sentence. In this section, the non-finite verbs in examples will appear in italics to help with their identification.

- (71) Gestern **hatte** ein Kind das Lied *gesungen*
 yesterday have.PST.3SG a child the song sing.PST.PTCP
 ‘Yesterday a child had sung the song.’ *German* (Uszkoreit, 1987, 21)

The position of the non-finite verbal elements differs for each of the six languages examined here. Their placement in verb second clauses will now be considered individually for each language. This will allow a full description of the verbal realization of a V2 clause.

In German, a clause consists of what is traditionally called the *Verbalklammer* ‘verb braces’ or *Satzrahmen* ‘sentence frame’. This frame begins after the first position of the sentence. So, the finite verb appears in the left part of the frame, that is, the second position, and all other non-finite verbs and verb parts appear in the right part of the frame at the end of the clause. All other clausal material appears between these two frame parts (Eisenberg, 1994). Consider the sentences in (72)–(73), the finite verb appears in the second position while all other non-finite verbs appear at the end of the clause.

- (72) Dann **wird** der Doktor die Pille dem Patienten *geben*.
 then will.PRS.3SG the doctor the pill the patient give.INF
 ‘Then the doctor will give the pill to the patient.’ *German* (Uszkoreit, 1987, 20)
- (73) Peter **will** nach Hause *gehen dürfen*.
 Peter want.PRS.3SG to home go.INF may.INF
 ‘Peter wants to be allowed to go home.’ *German* (Uszkoreit, 1987, 16)

Yiddish also attests this *Satzrahmen* like German. However, there are three variants known as the *Vollrahmen* ‘full frame’, the *Nullrahmen* ‘null frame’, and the *Teilrahmen* ‘part frame’ (Weissberg, 1988). In all three variants, the finite verb appears in the second position, but the position of the non-finite verbs vary. Sentences (74)–(76) provide examples for each of these types of word orderings. The *Vollrahmen* corresponds to the *Satzrahmen* appearing in German: The non-finite verbs appear at the end of the clause. The *Nullrahmen* positions the non-finite verbs directly after the second position finite verb allowing no intervening elements. And the *Teilrahmen* is an intermediate between the two, allowing intervening elements to appear between the finite and non-finite verbs, but the non-finite verbs do not appear clause final. In usage, the *Vollrahmen* is rare and the *Teilrahmen* is most preferred (Weissberg, 1988).

(74) Nullrahmen

Ix **hob** *gehat* a modnem poked farn hut.
 I have.1SG have.PST.PTCP a strange fear for.the hat

‘I was afraid of the hat.’ *Yiddish* (Weissberg, 1988, 152)

(75) Teilrahmen

M’**hot** durx ale fentster *arojssgehangn* wef.
 one=have.3SG through all windows out.hung.PST.PTCP laundry

‘Out of all the windows one hung the laundry.’ *Yiddish* (Weissberg, 1988, 153)

(76) Vollrahmen

Bald nox mojf **hat** si ojx gitelen *dersen*.
 soon after Moses have.PST.3SG she also Gitta see.PST.PTCP

‘Soon after Moses, she also saw Gitta.’ *Yiddish* (Weissberg, 1988, 153)

Both Kashmiri and Ingush follow the previous patterns and place non-finite verbs at the end of a verb second clause. The sentences in (77) and (78) illustrate the final position of the present participle and non-perfective verb forms in Kashmiri. Similarly, in Ingush all non-finite verbs as well as verb parts, as in German, appear clause finally. In example (79) from Ingush, the lexical verb appears finally while an auxiliary is in the second position (Nichols, 2009).

(77) B† **chus** kita:b *para:n*.

I.NOM be.1SG.M book read.PRS.PTCP

‘I am reading a book.’ *Kashmiri* (Wali and Koul, 1997, 83)

(78) LaRk **chu** dohay skuul *gatshaan*.

boy.NOM be.3SG.M daily school go.PRS.PTCP

‘The boy goes to school everyday.’ *Kashmiri* (Bhatt, 1999, 127)

(79) Muusaa **vy** hwuona telefon *jettaxh*.

Musa V.PROG you.SG.DAT telephone strike.CVB

‘It’s Musa on the phone for you.’ *Ingush* (Nichols, 2009)

Breton does not attest the pattern of the previous four verb second languages, that is, the non-finite verbs are not placed at the end of the clause. Rather the non-finite verbs appear near the finite

verb creating a contiguous verb cluster. Often non-finite verbs, such as past participles shown in (80a), appear in the first position before the finite verb. Alternatively, non-finite verbs may appear directly after the finite verb or after the subject which appears directly after the finite verb as illustrated in (80b)–(81).

- (80) a. *Debret en deus* Yann e voued er wetur.
eat.PST.PTCP 3SG.M have.PRS.3 Yann his food in.the car
- b. Yann *en deus debret* e voued er wetur.
Yann 3SG.M have.PRS.3 eat.PST.PTCP his food in.the car
- c. E voued *en deus debret* Yann er wetur.
his food 3SG.M have.PRS.3 eat.PST.PTCP Yann in.the car
'Yann has eaten his food in the car.' *Breton* (Press, 1986, 200)
- (81) Al levr *en deus* Yann *lennet* anezhañ.
the book 3SG.M have.PRS.3 Yann read.PST.PTCP it.OBJ
'Yann (has) read the book.' *Breton* (Press, 1986, 159)

In more complex verbal groups, the verb *bezañ* 'to be' is used to form the passive as in (82)–(84). The auxiliaries remain together as a continuous group in the second position and the non-finite verb may appear in the usual places. The variant forms of the auxiliary *bezañ* are due to the use of the analytic, *a zo*, or synthetic, *eo*, conjugation forms which depend on the position of the subject either before or after the finite verb (Press, 1986, 152).

- (82) *Kollet eo bet* ar voutailh gant Lan.
lose.PST.PTCP is.PRS.3SG is.PST.PTCP the bottle by Lan
- (83) Gant Lan *eo bet kollet* ar voutailh.
by Lan is.PRS.3SG is.PST.PTCP lose.PST.PTCP the bottle
- (84) Ar voutailh *a zo bet kollet* gant Lan.
the bottle PRT is.PRS is.PST.PTCP lose.PST.PTCP by Lan
'The bottle has been lost by Lan.' *Breton* (Press, 1986, 160)

Karitiâna attests similar behavior as Breton and maintains a continuous verb cluster in the second position. Storto (2003, 432) writes, "The matrix verb and aspectual auxiliary form a complex head that occupies second position" as shown in examples (85)–(86).

- (85) Iij **na-aka-t** *i-mboryt* epe-opo pi-ri.
bird PRT-COP-NFUT PRT-leave tree-hole place-from
'The bird left from the hold.' *Karitiâna* (Storto, 2003, 417)
- (86) Yn **na-aka-t** **i-so'oot-Ø** [taso õwã mi]=ty.
1 PRT-AUX-NFUT 3-see-NFUT [man child hit]=OBL
'I saw the man hurt the child.' *Karitiâna* (Storto, 2003, 431)

Additionally, some V2 languages, like German, have constructions which allow non-finite verbs to be placed in the first position either alone or in groups such as a partial verb phrase like the examples in (87). This phrase forms a single constituent containing some or all of the non-finite verbs which appears in the first position. Notice with the partial verb phrase examples, flexible word order allows various groupings of objects with the non-finite verb to appear as a single constituent.

- (87) a. [Das Buch *schenken*] **wollte** Peter dem Jungen.
the.ACC book give.INF want.PST.3SG Peter the.DAT boy
b. [Dem Jungen *schenken*] **wollte** Peter das Buch.
c. [Das Buch dem Jungen *schenken*] **wollte** Peter.
'Peter wanted to give the book to the boy.' *German* (adapted from Uszkoreit, 1987, 156)

2.6 Summary

In this chapter, I have provided a descriptive overview of verb second word order and the associated phenomena. Specifically, the previous sections reviewed the following properties of six sampled V2 languages, namely, Breton, German, Ingush, Kashmiri, Karitiâna, and Yiddish:

§2.1 These languages all attest V2 order for affirmative declarative main clauses. Other clause types, such as question and subordinate clauses, also attest V2 order for some of these languages. All of the six languages show the same word order properties for V2 clauses: A single constituent appears before the finite verb which must appear in the second position, and the non-verbal elements are flexibly realized around this inflexible non-finite verb.

§2.2 Not all clause types in a V2 language have V2 word order. The most common asymmetry is the root-subordinate asymmetry where main clauses have V2 word order and subordinate clauses do not. Some of the six reviewed V2 languages have this asymmetry and others do not. Furthermore, asymmetries can exist between all other clause types, not just between main and subordinate clauses. For instance, there are also root-question clause asymmetries. The types of asymmetries and the clauses which have some non-V2 word order are language-specific.

§2.3 The first position of a V2 clause is not restricted to a single type of element. Rather, in all six languages, the first position may contain any verbal argument, adjunct, non-finite verb, or complete clause—essentially any element but the finite verb. Word order flexibility facilitates this phenomenon by allowing any clausal element to be realized in the first position.

§2.4 In certain clause types or restricted environments, these languages may attest a verb third word order where the finite verb appears after two constituents. In all other regards, V3 clauses behave just like V2 clauses.

§2.5 There is no consistent placement of non-finite verbs among the six languages. Rather, there is wide variation for the neutral and allowable placements of the non-finite verbs, which appear in all possible places across all of the languages sampled. However, the non-finite verbs typically appear together as a contiguous unit.

The possible finite verb placements for the three general clause types examined here: main, subordinate, and question clauses, are summarized by the table in Figure 2.1 for all of the six examined languages¹. The standard finite verb placement in each clause, where V_I is verb initial and V_F verb final, is presented along with other more marginal verb placement possibilities, which appear in parentheses.

¹This table is based on a similar one presented by Nichols (2009) in her evaluation of the verb second phenomenon in Ingush where she was comparing its behavior to that of other V2 languages. The sources used to complete this summary include: Bhatt (1999), Borsley and Kathol (2000), Dudenredaktion (2005), Jacobs et al. (1994), Landin (1982), Landin (1984), Müller (2003), Nichols (2009), Press (1986), Stephens (2002), Storto (2003), Uszkoreit (1987), Wali and Koul (1997), and Weissberg (1988).

	Main:		Subordinate:		Question:	
	Affirmative	Negative	Content	Relative	Content	Polar
Breton	V2	V _I (V2)	V _I	V _I (V2)	V2	V2(V3/V _I)
German	V2(V3)	V2(V3)	V _F (V _I)	V _F	V2	V _I
Ingush	V2(V3)	V2	V _F	V _F	V2	V2
Karitiâna	V2/V _I (V3)	V2/V _I	V _F	V _F	V2	V2/V _I
Kashmiri	V2	V2	V2	V _F	V3	V2(V _I /V3)
Yiddish	V2(V3)	V2	V2	V2(V _I)	V2	V _I (V2)

Figure 2.1: Verb placement in various clause types. Non-basic alternative word orders appear in parentheses (V_I = verb initial and V_F = verb final).

In the remainder of this dissertation, I examine formalizations for the V2 phenomenon and consider its interaction with flexible word order. I then incorporate the generalizations of word order described in this chapter into cross-linguistically conscious and empirically-based formalizations of clause structure for V2 languages. This cross-linguistic analysis then provides insight for a flatter analysis of V2 word order, which directly encodes observable word order patterns as constructions.

Chapter 3

Frameworks and Previous Accounts

Syntactic analyses for flexible and verb second word order have been approached in a variety of manners and frameworks. All of these approaches presuppose some sort of larger clausal constituents, like a verb phrase. But because of the high degree of flexibility, as demonstrated in the previous chapter, it is difficult to consistently define what something like a verb phrase should contain, particularly when it could potentially be discontinuous. Often such structures are simply adopted from existing analyses, such as those for English, which generally has a consistent verb phrase. So, to begin to analyze flexible word order, one must first examine the types of constituency attested in these languages.

Traditionally, syntactic constituency is determined by examining the distributional properties of the elements in a sentence through “tests”, which may then be used to determine phrase structure. The word order of German may be exploited to a larger degree than other languages, like English, due to its flexibility (cf. Müller, 2008, Ch. 1.3). Namely, the displacement and prepending of elements become particularly important. For instance, consider the sentences in (88) where the phrase *diese Frau* ‘this woman’ is displaced as a single unit, thus indicating that it is a constituent.

(88) *Displacement*

- a. weil keiner [diese Frau] **kennt**
 because no.one this woman know.3SG.PRS
- b. weil [diese Frau] keiner **kennt**

‘because no one knows this woman’ *German* (Müller, 2008, 4)

The prepending test takes advantage of the verb second properties of German declarative main

clauses as described in §2.1. In such clauses, the finite verb may not be displaced but must appear immediately after what is generally viewed as a single constituent. The examples in (89), repeated here from Chapter 2, illustrate these V2 characteristics where the elements in a single utterance may be permuted into a variety of orderings. Thus, utilizing the V2 property which stipulates that only a single constituent may appear before the finite verb, one can presumably determine what the constituents of this German sentence are.

(89) *Prepending in V2 Clauses*

- a. Peter **wollte** dem Jungen das Buch schenken.
Peter want.3SG.PST the.DAT boy.DAT the.ACC book give.INF
- b. [Dem Jungen] **wollte** Peter das Buch schenken.
- c. [Das Buch] **wollte** Peter dem Jungen schenken.
- d. Schenken **wollte** Peter dem Jungen das Buch.
- e. [Das Buch schenken] **wollte** Peter dem Jungen.
- f. [Dem Jungen schenken] **wollte** Peter das Buch.
- g. [Das Buch dem Jungen schenken] **wollte** Peter.

‘Peter wanted to give the book to the boy.’ *German* (adapted from Uszkoreit, 1987, 156)

While the prepending test seemingly provides a simple way to determine constituent structure, it also underscores the variability and complexity of constituency in a flexible word order language, like German. That is, it cannot reliably indicate constituency structure. For instance, sentences (89e), (89f), and (89g) provide three different constituency patterns for the same elements: If *das Buch schenken* ‘the book give’ is considered a constituent in (89e), must it also be a constituent in (89b) while it certainly cannot be a continuous constituent in (89c)? Furthermore, if the verbal objects are considered to form a constituent with the verb to produce a traditional verb phrase, then the structure of the sentences in (89b) and (89c) may only be explained with discontinuous constituents. Thus, it is unclear what the constituent structure of such sentences are and if the elements before the finite verb in (89e) – (89g) do indeed form single constituents.

When such variability exists in the possible constituency of an utterance, it becomes more difficult to determine its most appropriate phrase structure. Thus, this may require the use of alternate phrase structure representations such as those with crossing branches, like the sentence in (90) examined by Bunt (1996, 73) in his *Discontinuous Phrase-Structure Grammar*, or mechanisms which allow the displacement of elements. Such word order may also require a notion of flexible constituency where a single set of elements may produce different syntactic groupings depending on the utterances in which they appear.

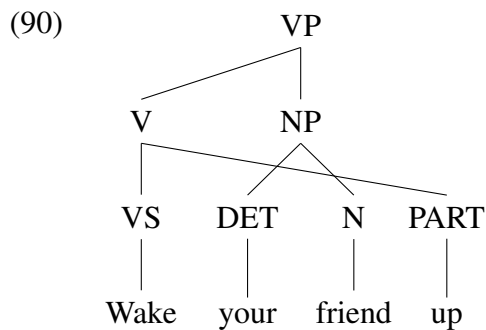

Other analyses model flexible word order with movement mechanisms, such as in more recent Chomskyan theories as well as constraint-based theories like Head-driven Phrase Structure Grammar (HPSG). For instance, these types of analyses necessarily require that the elements before the finite verb in (89) form a single constituent. Then a long-distance dependency, like extraction, licenses the realization of these initial elements.

Constituency, whose form, I will ultimately argue, is actually relatively flat, and the challenges it poses for syntactic theories will remain a theme throughout this dissertation. I show that utterances for flexible word order languages consist of few embedded structures and lack a traditional verb phrase like the prepending test suggests. This flatter approach more accurately reflects observable structures and word order patterns while avoiding non-transparent and untestable mechanisms, as supported by psycholinguistic evidence.

I also argue that some type of long-distance dependency in local contexts, e.g. within a single clause, to model either flexible word order or V2 is not supported by data. For instance, previous analyses model the first position of a V2 clause with a long-distance dependency either because it is viewed as a discourse operation like topicalization in English, it is presumably required to

account for semantic scoping relations, or it is necessary to allow embedded elements to appear in alternate positions. However, the data show that the first position need not have some special pragmatic properties, that scoping properties are better constrained by linear relationships, and that the apparent extraction of embedded elements is actually the result of other phenomena like reanalysis.

In this chapter, I provide detailed discussions of these arguments and introduce the common mechanisms and representations from a variety of frameworks for flexible word order and V2. This discussion will show that it is possible to express the relevant phenomena if constructions are flatter, just as the evidence seems to indicate. This flatter analysis will then be subsequently explored in Chapters 4 and 5.

3.1 Transformational Accounts

Mainstream Chomskyan syntactic theory resorts to structure-altering operations to describe flexible word order. For instance, consider the Russian example in (91) where all six logical orders of the syntactic elements are permissible. King (1993) provides an analysis of this phenomenon in a version of Government-Binding (GB) Theory (Chomsky, 1981) where she assumes that Russian has a pragmatically neutral VSO order which is produced from the standardly assumed underlying SVO structure for English. This is depicted in example (92) (cf. King, 1993, 92) which corresponds to (91e).

- (91) a. Ivan kupil knigu
 Ivan.NOM buy.3SG.PST book.ACC
 b. Ivan knigu kupil
 c. Knigu Ivan kupil
 d. Knigu kupil Ivan
 e. Kupil Ivan knigu
 f. Kupil knigu Ivan

‘Ivan bought the/a book’ *Russian* (van Gelderen, 2003, 35)

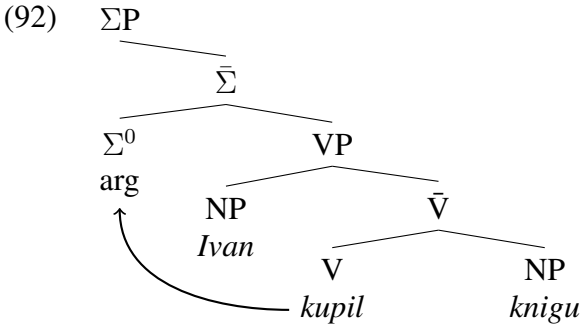

Under her analysis, the Spec ΣP positions, that is, the left child of the potentially multiple ΣP s, are associated with discourse functions such as topic and focus. The verb *kupil* ‘buys’ moves, via the standard GB ‘Move- α ’ operator, from the familiar English-centric structure to Σ^0 , where it receives the appropriate agreement inflection. The linear order of the sentence is read from the order of the nodes in the tree, which in this example produces VSO order. This structure then provides the underlying form of any clause with a transitive verb.

In order to produce the other possible linear orders of the sentence in (92), the verbal arguments would move to higher Spec ΣP positions. For example, consider the sentence in (91b) which reflects the case where the subject is the topic and the object is the focus. These two elements would move to their appropriate pre-verbal positions as illustrated in (93) (cf. King, 1993, 106). Thus, by moving the elements in the clause from their original underlying structure, various linear orders may be realized under this GB analysis. Similar movement analyses in GB use the ‘Move- α ’ operator to overcome the strict configurational stipulations of phrase structure and account for alternate word orders.

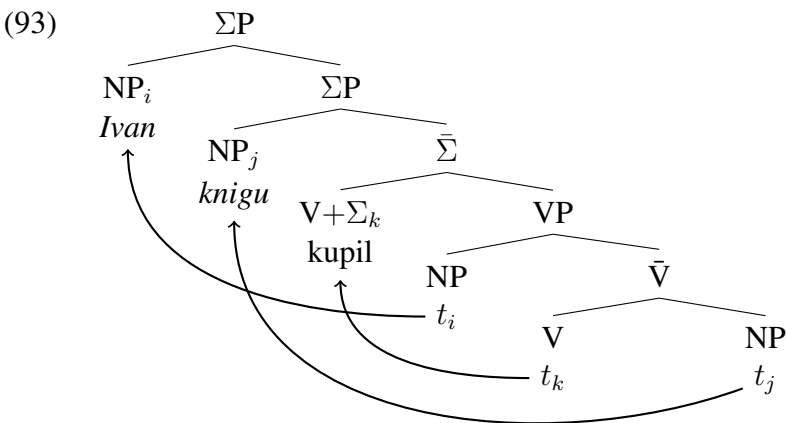

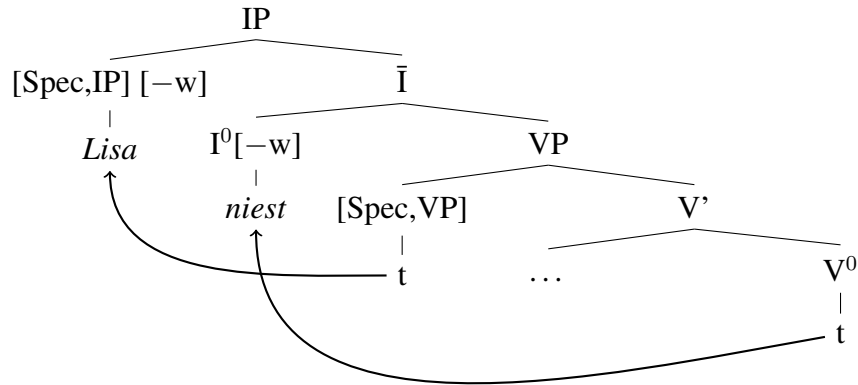

Figure 3.1: Analysis of main declarative German clause in GB.

Such movement-based approaches to flexible word order become even more complex in V2 clauses where the verb must appear in the second position. Generally, such clauses are treated as normal verb initial clauses with an extra element moved to a position before the verb.

3.2 Structure Modification or Direct Licensing?

As discussed in §3.1, analyses couched within the Government-Binding theory, generally speaking, are based on the initial projections of a verbal head, i.e. the underlying structure, and then the subsequent movement of elements to produce the appropriate surface word order. Kathol (2000, §7.3) argues against such analyses on grounds that they rely on ‘invisible syntactic entities’ which are ‘not expressed at the level where they are saliently manifested’. For instance, he considers one particular GB analysis which predicts the two structures in Figures 3.1 and 3.2 that are projected from two different lexical entries for *niesen* ‘to sneeze’. The first structure in Figure 3.1 depicts the analysis of a main declarative clause *Lisa niest* ‘Lisa sneezes’, while Figure 3.2 shows the polar question clause *Niest Lisa?* ‘Is Lisa sneezing?’. As shown in Chapter 2, the sentence mode constrains the possible positions of the finite verb, and by use of movement and projected features, such as the [w] marking for *wh* interrogatives, the GB analysis is able to account for these verb placements.

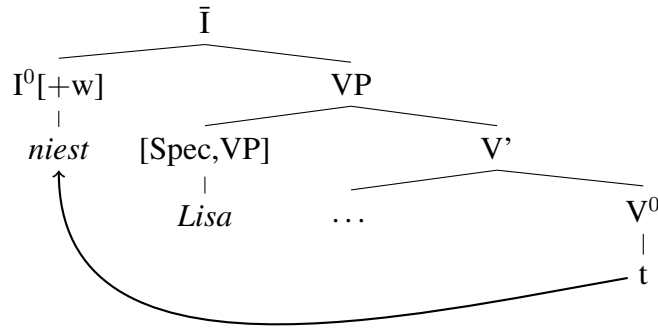

Figure 3.2: Analysis of interrogative German clause in GB.

Kathol (2000, 140–141) argues that because a language learner has only overt linguistic cues, such as intonation and linear word order, to deduce the mode (i.e. declarative, interrogative, ...) of an utterance, it is these linear patterns that will first be learned. That is, a learner will initially recognize the position of the verb in the various sentence types. It is only then that the learner could begin to “perform some act of implicit backwards engineering to arrive at the lexical specifications needed” (Kathol, 2000, 141). Thus, a purely construction-based account which directly encodes linear patterns at a phrasal level, instead of at a lexical level, is preferable to the complex abstract structures posited by such GB analyses.

These invisible features and movement operations pose learnability issues. A supporter of Universal Grammar (UG) would claim that such structure is predicted by the appropriate setting of parameters. Such an approach posits that given the “poverty of stimulus”, humans must possess innate knowledge about the types and forms of possible languages. This innate knowledge is represented as binary parameters, which are set through minimal exposure to a given language and encode such invisible features and operations. This hypothesis faces many challenges because the exact nature of these parameters is unclear. Newmeyer (2004) argues that in order to account for all the possible typological variation across languages, these parameters could number in the thousands, if not hundreds of thousands. It seems unlikely that humans are innately endowed with such a large amount of information, much of which encodes covert and complex mechanisms. Furthermore, Newmeyer argues that such a large number of parameters provides no advantage

over rule-based approaches. Instead, possible linguistics structures are more plausibly acquired by more general cognitive processes which deduce structure from reoccurring patterns. Additionally, Hawkins (2004) argues that the types of possible structures are derived from more general cognitive processes and performance pressures. As such, surface-oriented approaches are more reasonable than those that rely heavily on unobservable machinery.

The construction-based approach to grammar finds its roots with Bloomfield (1933) who presents syntax as a series of descriptive and holistic constructions, that is, ‘any meaningful, recurrent set of’ words and phrases. In fact, this type of characterization is also present in simple phrase structure rules which simply describe how elements may form larger units. This type of analysis is adopted by a group of surface-oriented analyses collectively known as Construction Grammar (CxG). These approaches strive for analyses which account for the observable behavior of language without positing any type of deep or hidden mechanisms. More recently, constructions are associated with Fillmore et al. (1988) and Kay and Fillmore (1999), whose work provides the foundation of Berkeley Construction Grammar (BCG), as well as Goldberg (1995), who states that constructions seek to define ‘form-meaning correspondences that exist independently of particular verbs’. This type of phrasal-based analysis has been formalized in Sign-Based Construction Grammar (SBCG) (Sag, 2010; Boas and Sag, 2012), which incorporates insights from BCG into the constraint-based formalism of HPSG (Pollard and Sag, 1994; Sag et al., 2003).

Michaelis (2012) characterizes the differences between generative-transformational and construction-based analyses by the types of constraints they impose: theories like GB have ‘a negative suppression’ strategy where the violation of a constraint indicates the ungrammaticality of an utterance, whereas licensing-based theories like HPSG and SBCG, have positive descriptions of the properties an expression must possess in order to be licensed as a grammatical sentence. That is, a licensing-based theory allows the cooperative interaction of various constraints.

Such licensing-based models of linguistic description provide two general benefits over their generative-transformational counterparts as described by Michaelis (2012): First, licensing-based models are more consistent with psychological evidence and allow the interaction of multiple sources of information like phonology, syntax, semantics, and pragmatics. This type of inter-

action “articulates closely with models of human sentence processing based on simultaneous constraint-satisfaction” such as attractor networks (cf. Sag, 1992; Sag and Wasow, 2011). Second, construction-based licensing models allow surface patterns to be directly encoded, thus providing a much larger descriptive capability. Generative-transformational grammars only account for ‘core’ phenomena while leaving no mechanisms to describe ‘peripheral’ ones.

Furthermore, Sag and Wasow (2011) examine these two differing types of formalisms and find that the type of parallel and non-destructive processing promoted in constraint-based models more accurately reflects performance capabilities. Early psycholinguistic processing models initially posited a link between the number of transformations involved in a sentence’s derivation and its psychological complexity, known as the ‘derivational theory of complexity’ (DTC) proposed by Chomsky (1968). So, according to the DTC, with each use of a deletion transformation in (94), the sentences should become harder to process. However, this link between the number of transformations and complexity could not be substantiated by psychological data (cf. Fodor et al. (1974)). Thus, due to the lack of evidence for transformations, they should be avoided.

- (94) a. Pat swam faster than Chris swam.
- b. Pat swam faster than Chris did.
- c. Pat swam faster than Chris.

Garden path sentences, Sag and Wasow (2011) explain, provided the original motivation for positing the modularity of syntax and successive use of transformations. That is, the obligatory and linear application of syntactic processes cause the difficulty in processing the sentence in (95), first reported by Bever (1970).

- (95) The horse raced passed the barn fell.

However, non-syntactic factors, such as context, can eliminate this difficulty as shown in (96) (Crain and Steedman, 1985).

- (96) The horse that they raced around the track held up fine. The horse that was raced down the road faltered a bit. And the horse raced past the barn fell.

The fact that the context can influence sentence processing shows that language comprehension involves the integration of non-linguistic information. So, Sag and Wasow (2011) argue that “[I]inguistic and nonlinguistic constraints on the interpretation are interleaved in real time”. That is, there is no ordering of operations, instead everything happens in parallel and simultaneously. This type of processing is best characterized by model-theoretic and constraint-based formalisms like HPSG, which license grammatical construction with sets of constraints that may be applied in any order or in parallel to allow information to be incorporated as it is encountered.

This type of incremental processing is clearly observable in everyday speech. Sag and Wasow (2011, §4.1) show that we process utterances word-by-word and can often deduce the meaning of a sentence before it is completed, regardless of its syntactic structures. In order to be able to process utterances in a surface-oriented manner, a grammar must provide the means to incrementally and efficiently analyze partial structures. This is unlike transformation-based analyses which require idiosyncratic underlying structures that are then subsequently modified to produce complete surface structures, not partial ones. Moreover, these “deep” structures in transformation-based analyses are often not observable in surface structures and thus not transparent to speakers. Constraint-based formalizations seek to maintain the transparency and thus verifiability of syntactic structures. Incremental processing becomes extremely important for flexible word order languages where syntactic structures with similar meaning can be expressed in a variety of surface realizations.

Movement-based theories do not provide any clear advantages over constraint-based theories. They are dependent upon abstract structures which are not directly observable and cannot account for all psycholinguistic performance evidence, particularly incremental processing. Instead multiple interacting constructions which encode various aspects of word order and syntactic constraints provide a better account of psycholinguistic evidence. It is this type of analysis, which directly encodes various aspects of interacting syntactic structure that I will advocate for the remainder of this dissertation.

3.3 A Constraint-based Approach

Head-Driven Phrase Structure Grammar (HPSG) (Pollard and Sag, 1994; Sag et al., 2003) offers an alternative to the previously predominate transformation-based approaches. HPSG is a constraint-based lexicalist grammar like Categorical Grammar, Generalized Phrase Structure Grammar (GPSG), and Lexical Functional Grammar (LFG). Instead of positing multiple layers of linguistic representation like a deep and surface structure, which are related through a series of movement operations, HPSG directly describes linguistic objects as well as the constraints on their realizations and combinations. New expressions or utterances are licensed by simultaneously satisfying the constraints of combinatorial structures (rules) and general principles. These constraints are represented in a mathematically-based manner which allow the precise description and verification of syntactic theories.

Insights from Berkeley Construction Grammar (Fillmore et al., 1988; Kay and Fillmore, 1999) were combined with HPSG resulting in Sign-Based Construction Grammar (SBCG) (Boas and Sag, 2012) which incorporates the basic ideas and motivations of CxG into a formal grammar.¹ Some main assumptions of this formalism are that linguistic objects are represented as feature structures which include both lexical and grammatical entities (Sag et al., 2012, 5). Both of these entities are treated in the same way as there is no formal distinction between them.

Linguistic feature structures in both HPSG and SBCG are represented as attribute-value matrices (AVMs) as illustrated in (97). These matrices are typed, and all structures of a particular type have the same set of features. The *sign* type in (97), a generic linguistic object, has the features PHON(OLOGY), (MORPHOLOGICAL) FORM, SYN(TAX), and SEM(ANTICS), which reflect the basic kind of information a linguistic entity has. These features then have values, which themselves may be types with their own features. For instance, the SYN attribute has two further attributes, CAT(EGORY) and VAL(ENCE). All types are organized in a hierarchy, as in Figure 3.3, which allows them to inherit the features from their parent type.

¹For a more detailed account of the origins of SBCG see (Sag et al., 2012)

$$(97) \left[\begin{array}{l} \textit{sign} \\ \text{PHON } \textit{phon-obj} \\ \text{FORM } \textit{morph-obj} \\ \text{SYN } \left[\begin{array}{l} \text{CAT } \textit{pos} \\ \text{VAL } \textit{list} \end{array} \right] \\ \text{SEM } \dots \end{array} \right]$$

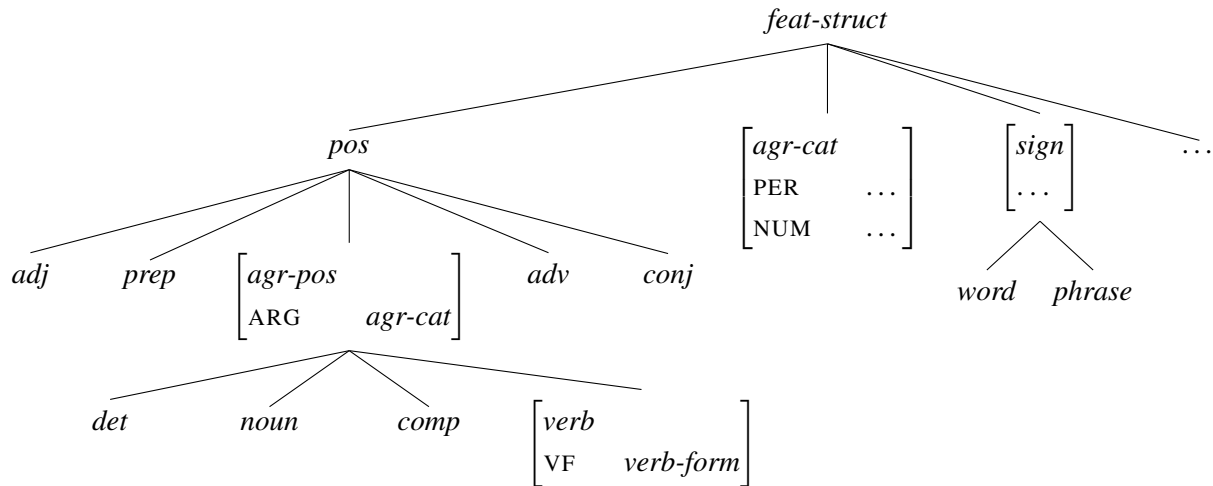
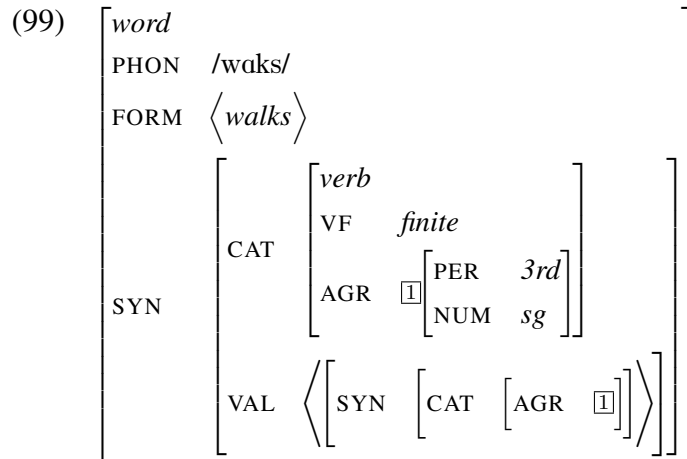

Figure 3.3: Sample type hierarchy in a constraint-based grammar.

For example, consider the representation of the word *Kim* as an AVM in (98). This structure is typed *word*, a sub-type of *sign*, and has all of this type’s attributes from (97). The CAT feature has a value of type *pos* (part-of-speech), which has multiple sub-types as illustrated in the hierarchy in Figure 3.3. All of these sub-types satisfy the constraint that the CAT feature be a *pos*. In particular, the AVM for *Kim* has a *pos* of *noun*, which is a direct sub-type of *agr-pos* and introduces the additional feature ARG. In this manner of filling in the values of the AVM while adhering to the constraints of the types, a full structure may be licensed.

$$(98) \left[\begin{array}{l} \textit{word} \\ \text{PHON } /kim/ \\ \text{FORM } \langle \textit{Kim} \rangle \\ \text{SYN } \left[\begin{array}{l} \text{CAT } \left[\begin{array}{l} \textit{noun} \\ \text{AGR } \left[\begin{array}{l} \text{PER } \textit{3rd} \\ \text{NUM } \textit{sg} \end{array} \right] \end{array} \right] \\ \text{VAL } \langle \rangle \end{array} \right] \end{array} \right]$$

Similarly, the verb *walks*, may also be licensed by the AVM in (99). This structure also contains a VAL argument whose AGR(ELEMENT) value is feature shared with that of the verb's, as indicated by the index [1]. This means that each of these AGR features point to the same values, thus ensuring that they are indeed identical. In this case, the PER(SON) and NUM(BER) values of the verb must be the same as the first argument, which ensures correct subject-verb agreement.



Having licensed a valid noun and verb, they may be combined with the the SUBJECT-PREDICATE CONSTRUCTION in (100a). This construction resembles a typical phrase structure rule but constrains the types of allowable signs. There are two daughters in this construction where the first daughter must be compatible, that is, able to unify, with the element on the VAL list of the second daughter. This is enforced by feature sharing these two structures. SBCG constructions often utilizes capitalized variables like *X* instead of numbered indices. Rules of this kind may be illustrated as trees as shown in Figure 3.4. While tree structures are not necessarily a formal mechanism of HPSG or SBCG, they help illustrate the application of constraints. Finally, it is most common for such constructions to be defined as single signs, like in (100b). Here, the DAUGHTERS list is the input to the construction and the MOTHER feature is the resulting structure. Furthermore, the SUBJECT-PREDICATE CONSTRUCTION is a headed structure where one of the DAUGHTERS is the HEAD-DAUGHTER, in this case the verb. When all of the arguments have been removed from the VALENCE list of a sign, such as by this construction, then the sign is considered fully saturated.

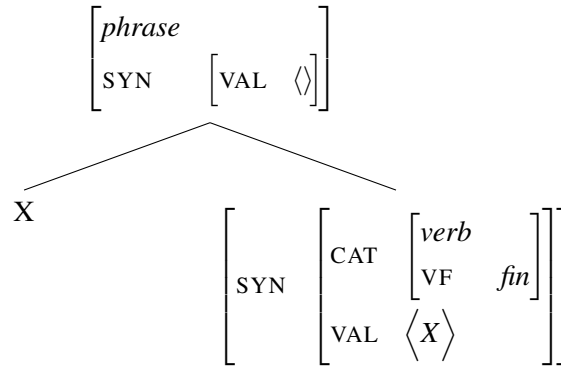
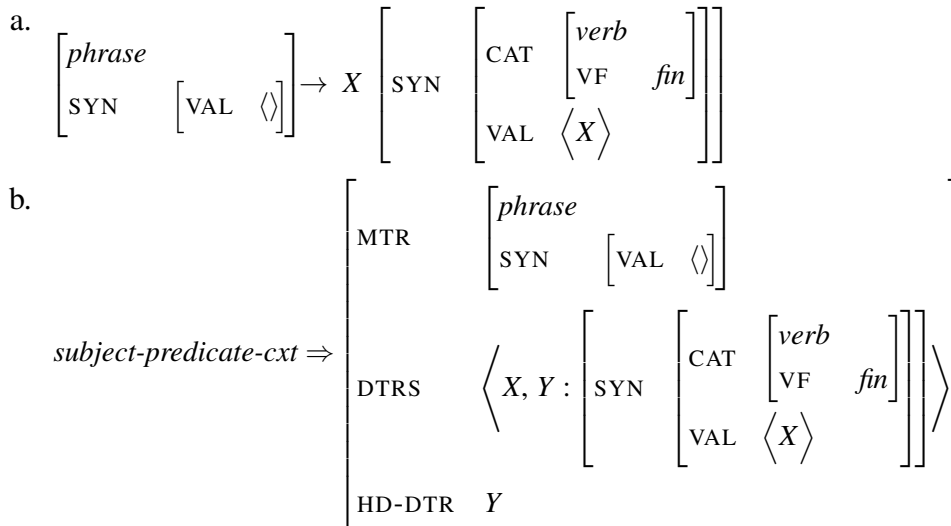

Figure 3.4: Tree representation of the SUBJECT-PREDICATE CONSTRUCTION.

(100) SUBJECT-PREDICATE CONSTRUCTION



Rules are also organized in a type hierarchy and inherit features from their parent types. For instance, consider the HEADED CONSTRUCTION in (101) which stipulates that the CAT value of the head daughter is the same as the CAT value of the resulting phrase. This construction is a parent type to all headed constructions, like the SUBJECT-PREDICATE CONSTRUCTION. So, the SUBJECT-PREDICATE CONSTRUCTION inherits the constraints of the HEADED CONSTRUCTION.

(101) HEADED CONSTRUCTION (Head Feature Principle)

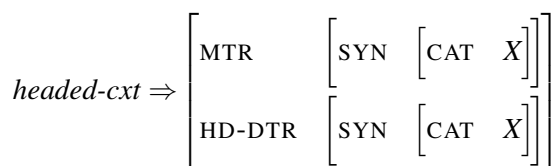

The structures for *Kim* and *walks* simultaneously satisfy the constraints as daughters of the SUBJECT-PREDICATE and HEADED CONSTRUCTIONS. Thus, they license the *phrase* “Kim walks” as illustrated by the tree structure in Figure 3.5. In SBCG, a box around the structure indicates that it is a specific instantiation of a feature structure rather than a feature structure description like in (100b).

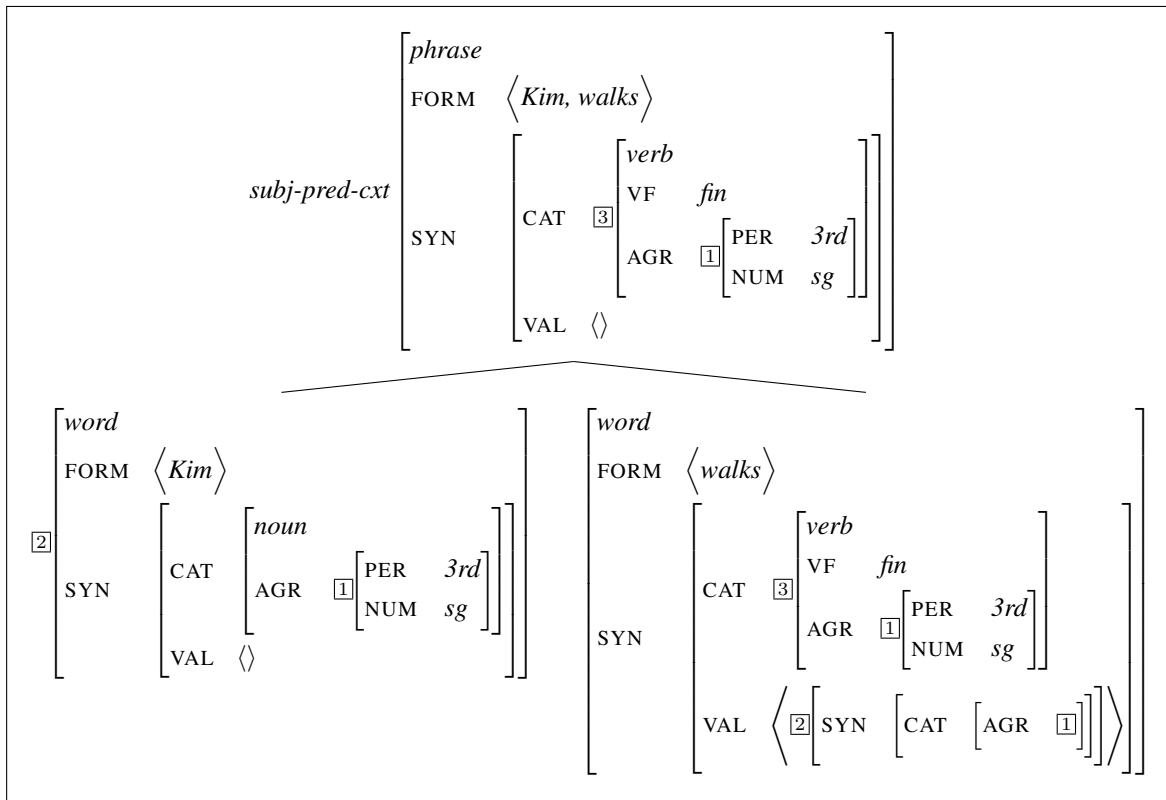

Figure 3.5: Sample fully licensed construction.

Such definitions of types and rules constrain the range of possible linguistic structures. All applicable constraints must be satisfied to license valid linguistic structures. It is not the case that one rule or constraint has precedence over the other. However, some rules do lead to the licensing of new structures which then themselves serve as input to further rules, in the standard fashion of a recursive grammar.

Additionally, the licensed tree structure in Figure 3.5 may also be represented as a single AVM in (102). This structure illustrates the common practice of abbreviating sub-structures with short-hand notations like $S[fin]$. This particular abbreviation stands for a *phrase* structure with a finite

verb head and an empty VAL list, that is, a fully saturated phrase. Similarly, the notation $VP[fin]$ represents a structure with a finite *verb* head but a VAL list with a single element.

$$(102) \left[\begin{array}{l} \textit{phrase} \\ \text{MTR} \left[\begin{array}{l} \text{FORM} \langle \textit{Kim, walks} \rangle \\ \text{SYN} \text{S}[\textit{fin}] \end{array} \right] \\ \text{DTRS} \left\langle \left[\begin{array}{l} \text{FORM} \langle \textit{Kim} \rangle \\ \text{SYN} \text{NP}[\textit{nom}] \end{array} \right], \left[\begin{array}{l} \text{FORM} \langle \textit{walks} \rangle \\ \text{SYN} \text{VP}[\textit{fin}] \end{array} \right] \right\rangle \end{array} \right]$$

The organization of constructions in type hierarchies is predominately a characteristic of SBCG. These hierarchies allow multiple inheritance to model the rich interaction of linguistic structures and constraints. It is particularly important to SBCG that constructions are underspecified and interact with each other. Sag et al. (2003, 471) provide a simple example of multiple inheritance to constrain the properties of lexemes with the small hierarchy in Figure 3.6. Here, the properties of lexemes have been divided into two groups: the part-of-speech and the type of argument the lexeme selects, which generalize the properties of lexemes. Furthermore, these two types of properties have various sub-types which fit into their respective categories. Each of the sub-types contain the features which describe and constrain that type of linguistic object. Types from each of these two groups may then be combined to license the final lexemes like *continue* and *eager*, where the features from their respective parent sub-types are inherited.

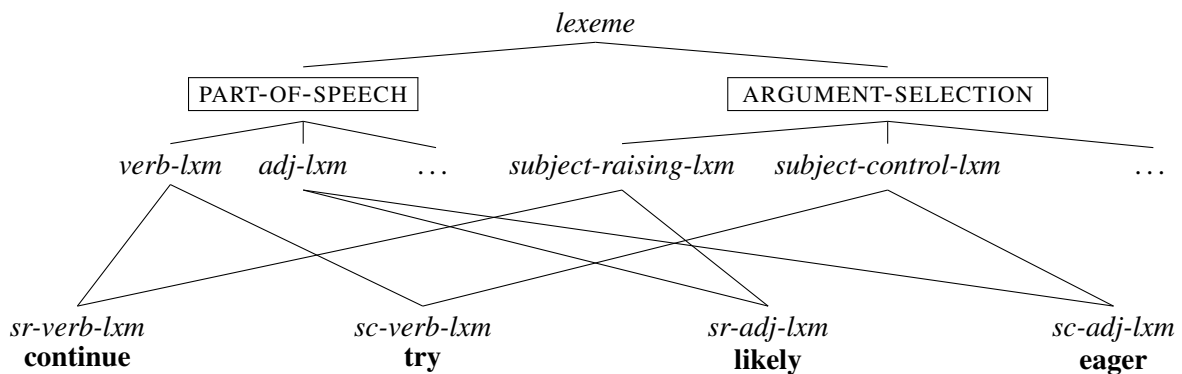

Figure 3.6: Sample construction hierarchy of lexemes (Sag et al., 2003, 471).

Hierarchies like the one in Figure 3.6 can also be extended to more complex types like phrases, which may be grouped by their corresponding functions. Thus, this formal construction-based approach allows generalizations across a language to be identified and organized in a way that they easily account for attested and observable linguistic phenomena.

3.4 Extraction-based Accounts for V2

Many accounts of V2 in HPSG assume that word order is derived via an extraction mechanism. Extraction is a family of constructions which links a fronted phrase to another which is located arbitrarily far away and may be embedded in other structures. This type of mechanism is often utilized in HPSG analyses to account for non-local, filler-gap phenomena like topicalization (cf. Sag, 2010). For instance, consider the sentence in (103) where *my bagels* has been topicalized and moved to the first position (Sag, 2010, 491). There is a gap after the verb *likes* where the object would normally appear, and the object is instead realized as a filler in the first position of the sentence.

(103) [My bagels]_i, she likes _{-i}.

In German, many analyses posit a similar operation with extraction to realize V2 word order (Pollard, 1996; Müller, 2002, 2005a, *inter alia*), which is reminiscent of similar obligatory movement operations in transformational approaches. Under this analysis, all V2 sentences are underlyingly verb initial clauses, such as example (104a). Then, extraction licenses the realization of a single phrase in the first position before the verb as illustrated in (104b)–(104d) resulting in V2 word order. Under such an approach, there is no V2 sentence which did not undergo some type of extraction.

- (104) a. **schenkt** Peter dem Jungen das Buch.
 give.3SG.PRS Peter the boy.DAT the book.ACC
 b. [Peter]_i **schenkt** _{-i} dem Jungen das Buch.
 c. [Dem Jungen]_i **schenkt** Peter _{-i} das Buch.
 d. [Das Buch]_i **schenkt** Peter dem Jungen _{-i}.

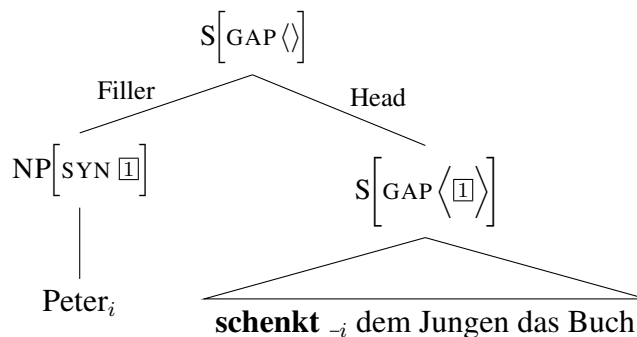

Figure 3.7: Example using the FILLER-HEAD CONSTRUCTION.

‘Peter gives the boy the book.’ *German*

Generally, extraction is licensed by some FILLER-HEAD CONSTRUCTION like in (105). This construction posits a GAP feature which contains any elements which are to be licensed as a long-distance dependency. There are two daughters in this construction. If the SYN of the first daughter matches the item on the GAP list, then the daughters may be combined and the element removed from the GAP list. The tree in Figure 3.7 illustrates the general phrase structure resulting from extraction via the FILLER-HEAD CONSTRUCTION to license the sentence in (104b). This process thus allows the licensing of a V2 clause as a consequence of extraction.

(105) FILLER-HEAD CONSTRUCTION

$$filler-hd-ext \Rightarrow \left[\begin{array}{l} \text{MTR} \quad \left[\text{SYN} \quad \left[\text{GAP} \quad \langle \rangle \right] \right] \\ \text{DTRS} \quad \left\langle \left[\text{SYN} \quad X \right], Y : \left[\text{SYN} \quad \left[\text{GAP} \quad \langle X \rangle \right] \right] \right\rangle \\ \text{HD-DTR} \quad Y \end{array} \right]$$

The constructions and features associated with extraction have various names in the literature with nearly identical properties. In earlier HPSG analyses, the FILLER-HEAD CONSTRUCTION is often called the HEAD-FILLER SCHEMA, and the GAP feature is also known as the SLASH feature.

3.4.1 Verb Inversion

Following the general tradition of German grammarians, Pollard (1996) proposes that the basic order of a German clause is verb final while adopting an extraction-based approach to V2 word

order. Because this approach realizes V2 by extracting an element from a verb initial clause, it is incompatible with verb final word order. To reconcile this difference, he borrows the INV(ERTED) feature from English subject-auxiliary inversion analyses in combination with linear precedence (LP) rules. LP rules provide general constraints on the ordering of elements when their order is otherwise not specified, as is common in GPSG (Gazdar et al., 1985).

These LP rules state that when a verbal phrase is not inverted, INV –, the finite verb must appear after all other constituents in the phrase as in (106). If the phrase is inverted, INV +, then the verb must appear before all of the other constituents in the phrase as in (107). Thus, this feature provides for the realization of verb initial word order from a basic verb final order. Once a verb phrase has been inverted to license a verb initial ordering, an element may be extracted to the initial position to consequently produce V2 word order as illustrated in (107b).

- (106) a. dass Hans das Haus bauen **wird**.
 COMP Hans the house build.INF will.3SG
 ‘that Hans will build the house’ *German*

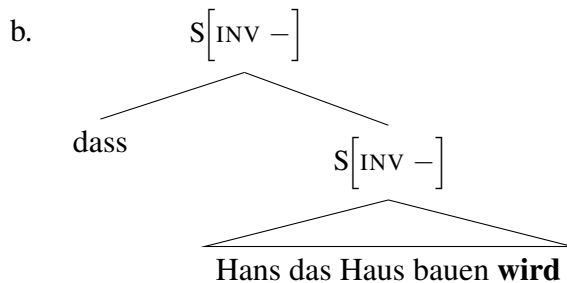

- (107) a. Das Haus **wird** Hans bauen.
 the house will.3SG Hans build.INF
 ‘Hans will build the house.’ *German*

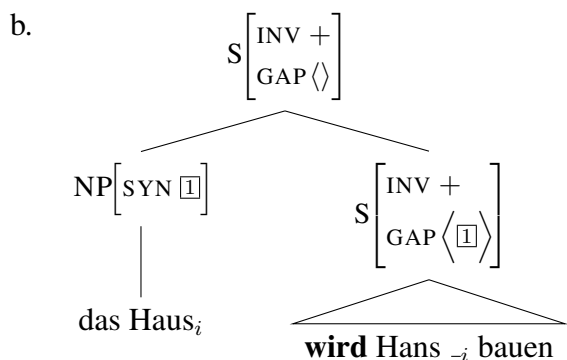

The extraction mechanism allows only one constituent to be fronted at a time. However, Pollard offers no constraints on the number of times this mechanism may be employed to avoid multiple extracted elements before an inverted verb. Such multiple extractions could potentially license ungrammatical sentences.

3.4.2 Verb Traces

Similarly, Müller (2005a) also uses extraction to account for V2 word order as well as verb traces. Under his analysis German has basic verb final word order, and all other verb placements are derived from this ordering. For example, consider the progression of derivations in (108). The first subordinate clause is verb final and does not require any derivation. Next, the polar question clause is verb initial and requires that the verb be extracted to the front of the clause. Finally, in the last V2 sentence, an element is extracted from the V1 clause to the first position.

- (108) a. dass er das Buch **kennt**.
 COMP he the book know.3SG
 ‘that he knows the book.’
- b. **Kennt**_j er das Buch _{-j}?
 ‘Does he know the book?’
- c. Das Buch_i **kennt**_j er _{-i} _{-j}.
 ‘He knows the book.’ *German*

Unlike the previous inversion analysis, Müller posits that the verb is extracted to the initial position via the VERB TRACE in (109). This trace uses the DSL (DOUBLE SLASH) feature, which was first introduced by Jacobson (1987), to license the verbal extraction. This DSL feature behaves like the GAP feature, but is reserved for local dependencies. This verb trace has no phonological realization, acquires the arguments of the verb, and combines with all of the verbal arguments.

(109) VERB TRACE (cf. Müller, 2005a, 9)

a. A phonologically empty trace has the same valents as some gapped verb.

b.

$$verb\text{-}trace \Rightarrow \left[\begin{array}{l} PHON \langle \rangle \\ SYN \left[\begin{array}{l} CAT \left[\begin{array}{l} verb \\ DSL \left[SYN \left[VAL \boxed{I} \right] \right] \right] \right] \\ VAL \boxed{I} \end{array} \right] \end{array} \right]$$

Only an INITIAL + verb, similar to the previous INV feature, may then combine with a fully saturated verb trace. An initial verb is derived from a basic, non-initial verb as formalized in (110). This rule licenses the initial verb in sentences like (108b) where a verb trace appears in the final position.

(110) VERB FIRST LEXICAL RULE (cf. Müller, 2005a, 11)

a. An initial verb is derived from a non-initial verb. The initial verb subcategorizes for a verb trace which has the valents of the non-initial verb.

b.

$$vI\text{-}lex\text{-}rule \Rightarrow \left[\begin{array}{l} MTR \left[\begin{array}{l} SYN \left[\begin{array}{l} CAT \left[\begin{array}{l} verb \\ VF \quad fin \\ INITIAL \quad + \end{array} \right] \\ VAL \left\langle \left[SYN \left[\begin{array}{l} CAT \left[\begin{array}{l} verb \\ DSL \left[VAL \boxed{I} \right] \right] \right] \right] \\ VAL \langle \rangle \end{array} \right] \right] \right] \end{array} \right] \end{array} \right] \\ DTRS \left\langle \left[\begin{array}{l} SYN \left[\begin{array}{l} CAT \left[\begin{array}{l} verb \\ VF \quad fin \\ INITIAL \quad - \end{array} \right] \\ VAL \boxed{I} \end{array} \right] \right] \right] \right\rangle \end{array} \right]$$

Finally, the HEAD-FILLER SCHEMA in (111) allows a gapped element from a saturated initial verb element to combine with a filler to license verb second word order.

(111) HEAD-FILLER SCHEMA (cf. Müller, 2005a, 15)

- a. A saturated verbal structure consists of a filler and the verb initial structure which has gapped it.

b.

$$\begin{array}{l}
 \text{hd-filler-schema} \Rightarrow \left[\begin{array}{l}
 \text{MTR} \quad \left[\text{SYN} \quad \left[\text{GAP} \quad \langle \rangle \right] \right] \\
 \text{DTRS} \quad \left\langle \left[\text{SYN} \quad X \right], Y : \left[\text{SYN} \quad \left[\begin{array}{l}
 \text{CAT} \quad \left[\begin{array}{l}
 \text{verb} \\
 \text{VF} \quad \text{fin} \\
 \text{INITIAL} \quad +
 \end{array} \right] \right] \right] \\
 \text{VAL} \quad \langle \rangle \\
 \text{GAP} \quad \langle X \rangle
 \end{array} \right] \right\rangle \\
 \text{HD-DTR} \quad Y
 \end{array} \right]
 \end{array}$$

The application of these structures to license the V2 sentence in (108) is illustrated in Figure 3.8. The verbal arguments are combined with the verb individually via a HEAD-COMPLEMENT CONSTRUCTION in a fashion similar to the SUBJECT-PREDICATE CONSTRUCTION, thus creating a binary branching structure. The arguments may combine with the verb in any order to allow flexible word order. Unlike the transformation accounts in §3.1, there is no movement or extraction to account for flexible word order. However, extraction, via GAP or DSL, is required to correctly place non-clause final verbs and initial elements in V2 clauses. So, in some ways, this analysis does resemble the binary branching transformation accounts which rely heavily on movement.

One of the primary motivations for an extraction-based analysis, Müller argues, is because of long-distance phenomena like the one in (112). Here, a prepositional phrase has been extracted from an embedded clause to the first position of the matrix clause. He concludes that the first position must be licensed by extraction and then generalizes this to all V2 sentences, including those which consist of only a single clause like in (108). Thus, he assumes that the first position must be realized solely by use of extraction, even in local contexts.

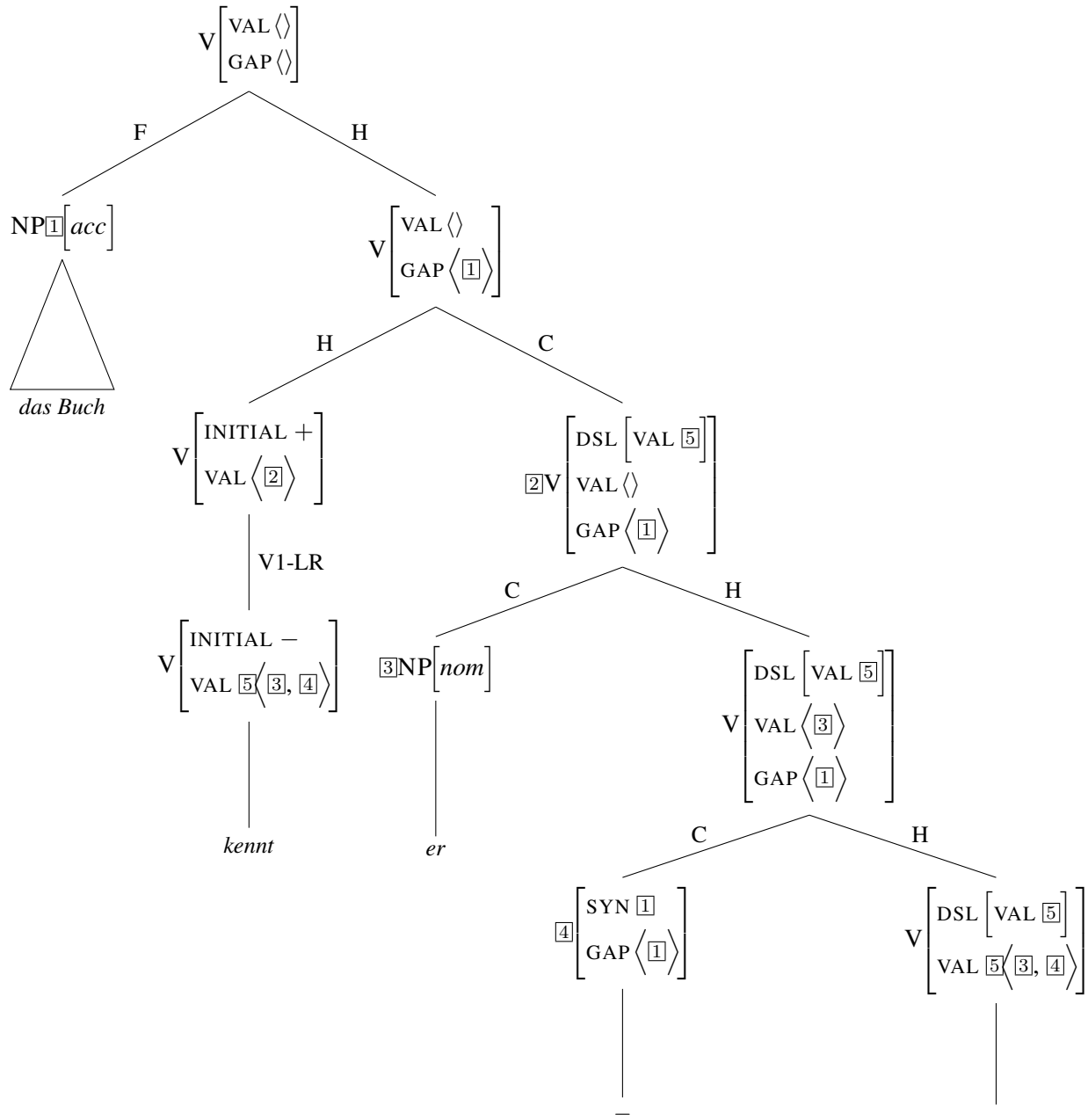

Figure 3.8: Analysis of German V2 clause with verb trace (cf. Müller, 2005a, 16).

- (112) [Um zwei Millionen Mark]_i **soll** er versucht haben, [eine
of two million mark should.3SG.PRS he try.PST.PTCP have.INF a
Versicherung _{-i} zu betrügen].
insurance to defraud.INF
‘Of two million marks, he is trying to defraud an insurance company.’ *German* (Müller,
2005a)

However, the commitment to a long-distance dependency as the mechanism responsible for the realization of the first element in a V2 clause begins to complicate the analyses of more complex and “non-core” sentences such as the V3 example in (113), namely because such analyses only allow a single extraction. The V3 sentence has a similar positional constraint as V2 sentences, but the finite verb must appear after two constituents, not one. Contextual and pragmatic factors license the appearance of two elements in what was a single first position.

- (113) a. [Zum zweiten Mal] [die Weltmeisterschaft] **errang** Clark 1995
 the.DAT second time the world.championship win.1SG.PST Clark 1995
 ‘Clark won the world championship for the second time in 1995.’ *German* (Müller, 2005b)
- b. [_{VP}[zum zweiten Mal] [die Weltmeisterschaft] _{-V}]_i errang_j Clark 1965 _{-i -j}.

In order to maintain an extraction-based analysis which places a single element in the position before the finite verb, the first two elements must, in fact, form a single unit. Müller (2005b) posits that an empty verbal head combines the two fronted elements, so that they may function as a single constituent and be extracted. This structure is schematically shown in (113b). The licensing of this structure requires the previous rules as well as an additional MULTIPLE FRONTING LEXICAL RULE in (114), which derives a new verb that subcategorizes for a verb trace and its arguments. The exact function of this rule is unclear, but Müller (2005b, 19) provides a full parse of the V3 sentence from (113) in Figure 3.9 to illustrate its use. This resulting structure suffers the same crucial shortcoming as the generative-transformational analysis: The analysis contains many abstract elements which cannot be independently motivated and are not explicitly observable, thus posing problems for learnability.

3.5 Liberation and Domain-based Accounts

Traditional phrase structure rules encode both constituent structure and linear order. As an alternative, Curry (1961) proposed a division where rules are split along tecto and phenogrammatical dimensions. That is, some rules encode the immediate dominance (ID) of elements, while others encode linear precedence (LP) and constrain their linear order. For instance, the ID rule in (115a) states that some structure A dominates the structures B, C, and D. This rule stipulates constituent structure and any order of these elements, as illustrated in (115b), satisfy this ID rule. Thus, in the case of V2 word order, a single constituent's domain may be relegated to the first position by an LP rule without modifying the clause's constituent structure. This approach reflects the intuition that the same syntactic and semantic structures occur despite linear order.

(115) a. $A \rightarrow B C D$

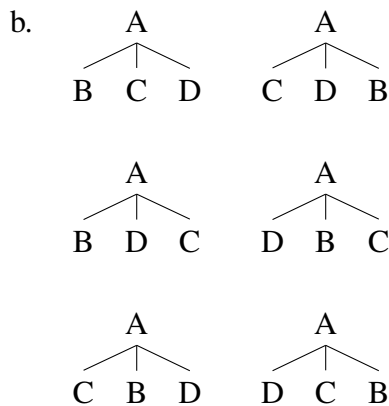

Zwicky (1986) and Dowty (1996) later extend the ID/LP division with the idea of *liberation*, which allows the elements dominated by different parents to appear in linear orders where they are intertwined. This effectively results in tree structures with crossing branches like the tree in (90) discussed at the beginning of this chapter. Building off of this idea, Reape (1994, 1996) posits *word order domains* and defines them as the units that may be mixed together via a shuffle operation, expressed by the symbol ‘ \circ ’, to create various word orderings. All elements appear in a domain and the combinatorial rules define how domains are created. The domains of all constituents are combined together so that they may all shuffle with each other. The shuffle operation describes how the different orders in (115b) are obtained. For instance, consider two list of elements which

each contain two domains: $A = \langle a, b \rangle$ and $B = \langle c, d \rangle$. These two lists may be shuffled together so that they produce all the orderings containing the combined elements where the relative order of the elements in the individual lists is maintained:

$$A \circ B = \begin{aligned} &\langle a, b, c, d \rangle \vee \\ &\langle a, c, b, d \rangle \vee \\ &\langle a, c, d, b \rangle \vee \\ &\langle c, a, b, d \rangle \vee \\ &\langle c, a, d, b \rangle \vee \\ &\langle c, d, a, b \rangle \end{aligned}$$

Moreover, additional LP rules may be defined to further constrain the allowed orders. For example, it could be stipulated that domain b always occurs before d , written $b \prec d$. This would eliminate the third, fifth, and sixth orderings above because they would violate this LP rule. So, by liberating the elements in a clause and allocating them to domains, it is possible to freely shuffle words while also constraining them with linear precedence rules.

This shuffle operation as applied to German word order is illustrated by the example in (116) adapted from Reape (1994, 159). Consider the subordinate clause in (116a) with verb final word order. Because German has flexible word order, the noun phrases may appear in other orders. This flexibility is formalized by placing all of the noun phrases and verbs into individual $\text{DOM}(\text{AINS})$, as illustrated in (116b). These domains may then shuffle with each other to produce various orderings.

However, not all orders are allowed, so Reape (1994, 158) defines two main LP rules which correctly constrain the possible orders: First, noun phrases occur before verbal elements, $NP \prec V$, and a verb follows any verb that it governs. The domain tree in (116c) shows the word order domains as they saturate the arguments for their respective verb. This tree assumes a flatter structure where all verbal arguments are combined with a predicate at the same time. The domains at each level are combined so that domains from embedded structures can still shuffle in non-local environments. The final order of elements is read from the domains and not from the application of grammar rules such as those which saturate arguments. This combination of domains and LP rules allows for the word orders shown in (116d).

- (116) a. dass es ihm jemand zu lesen versprochen hat
 that it.ACC him.DAT someone.NOM to read.INF promise.PST.PTCP have.3SG.PRS
 ‘that someone promised him to read it’ *German* (Reape, 1994, §5.3)

b. $\left[\text{DOM} \langle \langle es \rangle \rangle \circ \langle \langle ihm \rangle \rangle \circ \langle \langle jemand \rangle \rangle \circ \langle \langle zu \text{ lesen} \rangle \rangle \circ \langle \langle versprochen \rangle \rangle \circ \langle \langle hat \rangle \rangle \right]$

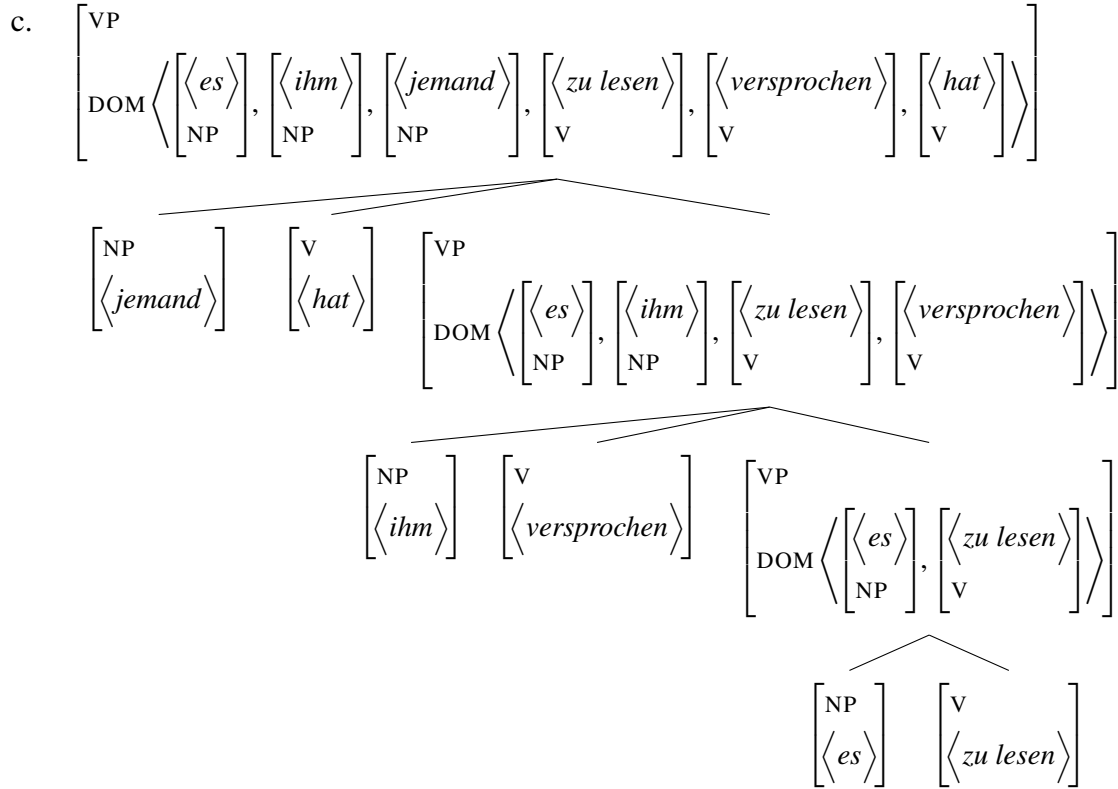

- d. i. es ihm jemand zu lesen versprochen hat
 ii. es jemand ihm zu lesen versprochen hat
 iii. ihm es jemand zu lesen versprochen hat
 iv. ihm jemand es zu lesen versprochen hat
 v. jemand es ihm zu lesen versprochen hat
 vi. jemand ihm es zu lesen versprochen hat

3.5.1 Topological Fields

Using word order domains and their ability to independently determine word order separate from combinatorial rules, Kathol (2000) develops a comprehensive grammar of German by appealing to the standard and traditional notion of topological fields (Drach, 1937; Reis, 1980; Höhle, 1986;

Askedal, 1986). Traditional German grammar accounts for word order by dividing a sentence into fields such as the *Vorfeld* ‘pre-field’, *complementizer field*, *Mittelfeld* ‘middle field’, *verb cluster*, or *Nachfeld* ‘final field’. In these traditional analyses, words are placed into particular fields according to the type of clause being instantiated. For example, in a main clause, the finite verb would appear in the *complementizer field* with one element in the *Vorfeld*, while in a subordinate clause, the finite verb appears in the *verb cluster*. The sentences in (117) are organized into the fields as shown in Figure 3.10. All three main verb placements are shown here, where the *Nachfeld* would be used for any potentially extraposed elements.

- (117) a. ... dass er das Buch **kennt**.
 COMP he the book know.3SG
 ‘... that he knows the book.’
- b. **Kennt** er das Buch?
 ‘Does he know the book?’
- c. Das Buch **kennt** er.
 ‘He knows the book.’ *German*

Vorfeld	Comp. Field	Mittelfeld	Verb Cluster	Nachfeld
das Buch	kennt	er		
	kennt	er das Buch		
	dass	er das buch	kennt	

Figure 3.10: German topological fields.

Topological fields only appeal to linear distributional properties and need not make any claims concerning constituent structure (Kathol, 2000, 47). This property lends itself well to be represented by word order domains. Thus, to enable his analysis, the basic HPSG *sign*, which subsumes both *words* and *phrases*, is modified to include a domain feature which itself contains a list of *signs* along with their topological field information. All *signs* in this domain list inherit a TOPO feature which corresponds to one of the five traditional topological fields, effectively marking the clausal position of the domain. This modified *sign* is illustrated in (118). The phonology of this sign

is produced by the concatenation of its domains, in whichever order they appear, via an append operator \oplus^2 , not to be confused with the shuffle operator \circ .

$$(118) \left[\begin{array}{l} \text{sign} \\ \text{PHON } \boxed{1} \oplus \boxed{2} \oplus \dots \oplus \boxed{n} \\ \text{DOM} \left\langle \left[\begin{array}{l} \text{sign} \wedge \text{topo} \\ \text{PHON } \boxed{1} \end{array} \right], \left[\begin{array}{l} \text{sign} \wedge \text{topo} \\ \text{PHON } \boxed{2} \end{array} \right], \dots, \left[\begin{array}{l} \text{sign} \wedge \text{topo} \\ \text{PHON } \boxed{n} \end{array} \right] \right\rangle \end{array} \right]$$

(Kathol, 2000, 77)

Furthermore, before any such concatenation of domain objects occur, the *sign* must satisfy the constraint set forth by the TOPOLOGICAL LP STATEMENT in (119) which dictates the order in which the domains of a given *topo* type must be realized. This ensures, for instance, that the one element in the *Vorfeld* domain precedes, ‘<’, the finite verb in the *complementizer field* domain. All topological fields must not be present in a clause, but the occurring ones must appear in the stipulated order.

(119) TOPOLOGICAL LP STATEMENT (Kathol, 2000, 79)

$$vf < cf < mf < vc < nf$$

Generally, most “nonverbal phrasal arguments are typed *mf*” (Kathol, 2000, 83), whereas *verbal* elements must inherit either *cf* or *vc*. Only finite verbs may belong to the *cf* field to the exclusion of non-finite verbs as in example (120). A non-verbal argument may appear in *vf* reflecting a standard verb second clause like in (121). Additionally, the *cf* field may alternatively contain a complementizer to account for verb final order in a clause like (122).

(120) a. **Sieht** Lisa die Blume?
see.3SG Lisa the flower
‘Does Lisa see the flower?’ *German* (Kathol, 2000, 80)

$$b. \left[\text{DOM} \left\langle \left[\begin{array}{l} cf \\ \text{FORM} \langle \text{sieht} \rangle \\ \text{V} [\text{FIN}] \end{array} \right], \left[\begin{array}{l} mf \\ \text{FORM} \langle \text{Lisa} \rangle \\ \text{NP} [\text{NOM}] \end{array} \right], \left[\begin{array}{l} mf \\ \text{FORM} \langle \text{die Blume} \rangle \\ \text{NP} [\text{ACC}] \end{array} \right] \right\rangle \right]$$

²The append operator simply combines lists. For example, $\langle A, B \rangle \oplus \langle C, D \rangle = \langle A, B, C, D \rangle$.

- (121) a. Die Blume **sieht** Lisa.
 the flower see.3SG Lisa
 ‘Lisa sees the flower.’ *German* (Kathol, 2000, 80)

$$b. \left[\text{DOM} \left\langle \left[\begin{array}{l} vf \\ \text{FORM} \langle \textit{die Blume} \rangle \\ \text{NP}[\text{ACC}] \end{array} \right], \left[\begin{array}{l} cf \\ \text{FORM} \langle \textit{sieht} \rangle \\ \text{V}[\text{FIN}] \end{array} \right], \left[\begin{array}{l} mf \\ \text{FORM} \langle \textit{Lisa} \rangle \\ \text{NP}[\text{NOM}] \end{array} \right] \right\rangle \right]$$

- (122) a. dass Lisa die Blume **sieht**.
 COMP Lisa the flower see.3SG
 ‘that Lisa sees the flower.’ *German* (Kathol, 2000, 80)

$$b. \left[\text{DOM} \left\langle \left[\begin{array}{l} cf \\ \text{FORM} \langle \textit{dass} \rangle \\ \text{COMP} \end{array} \right], \left[\begin{array}{l} mf \\ \text{FORM} \langle \textit{Lisa} \rangle \\ \text{NP}[\text{NOM}] \end{array} \right], \left[\begin{array}{l} mf \\ \text{FORM} \langle \textit{die Blume} \rangle \\ \text{NP}[\text{ACC}] \end{array} \right], \left[\begin{array}{l} vc \\ \text{FORM} \langle \textit{sieht} \rangle \\ \text{V}[\text{FIN}] \end{array} \right] \right\rangle \right]$$

Additionally, a verbal argument, that is, another clause, may be placed in the *nf* position like in (123) or alternatively within the *mf*.

- (123) a. Lisa **glaubt** die Blume zu sehen.
 Lisa believe.3SG the flower to see.INF
 ‘Lisa believes she sees the flower.’ *German* (Kathol, 2000, 95)

$$b. \left[\text{DOM} \left\langle \left[\begin{array}{l} mf \\ \text{FORM} \langle \textit{Lisa} \rangle \\ \text{NP}[\text{NOM}] \end{array} \right], \left[\begin{array}{l} vc \\ \text{FORM} \langle \textit{glaubt} \rangle \\ \text{V}[\text{FIN}] \end{array} \right], \left[\begin{array}{l} nf \\ \text{FORM} \langle \textit{die Blume zu sehen} \rangle \\ \text{VP}[\text{INF}] \end{array} \right] \right\rangle \right]$$

There may only be one element in the *vf* field, as there is only one constituent before the finite verb of a V2 clause. Similarly, there may only be one element in the *cf* field, either a finite verb or a complementizer. To ensure that only one element may appear in these fields, the TOPOLOGICAL CARDINALITY CONDITIONS in (124) stipulate that only one domain object may appear in the positions by exploiting a logical trick of LP rules: These linear precedence rules state that a *vf* or *cf* domain must appear before another *vf* or *cf* domain respectively. If there is more than one such domain, this rule cannot possibly be satisfied thus effectively restricting the fields to one domain. Although these rules constrain these two topological fields, the constraint is only achieved as a

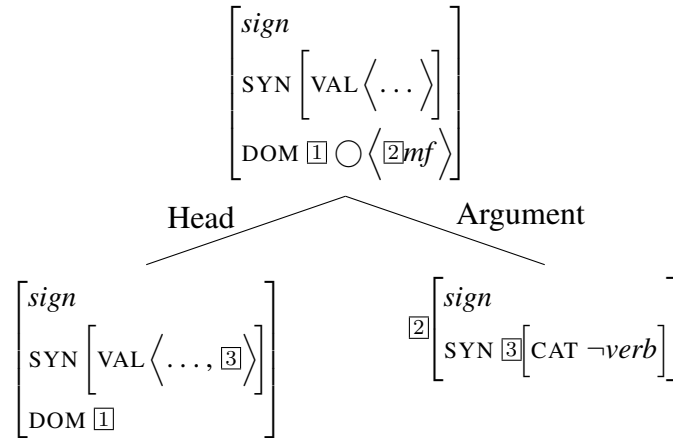

Figure 3.11: HEAD-ARGUMENT SCHEMA with topological domains.

consequence of the logical structure of the grammar formalism and is not necessarily motivated by linguistic structure.

(124) TOPOLOGICAL CARDINALITY CONDITIONS (Kathol, 2000, 88)

- a. $vf \prec vf$
- b. $cf \prec cf$

With the addition of TOPO to a domain element, the common HPSG grammar rules can now directly reference the topological field elements they affect. For example, the HEAD-ARGUMENT SCHEMA in Figure 3.11 designates that non-verbal arguments acquire the *mf* TOPO type when combining with a verb (cf. Kathol, 2000, 84). Furthermore, one of these arguments may then be placed into the *vf* position via the HEAD-FILLER SCHEMA in Figure 3.12 (cf. Kathol, 2000, 86). This rule employs the standard GAP feature as used in the extraction-based approaches in §3.4.

3.5.2 German Constructions

Kathol (2000) employs a construction-based approach for describing the various clausal structures in German, which is formulated in an earlier version of SBCG. This approach, unlike the reductionist view, does not utilize lexical features as the sole determiner of word combinations and linear order. Rather, the relationships between “larger syntactic entities and constraints on meaning”, that is, constructions, determine the linear order of clausal elements (Kathol, 2000, 141). Thus, clausal

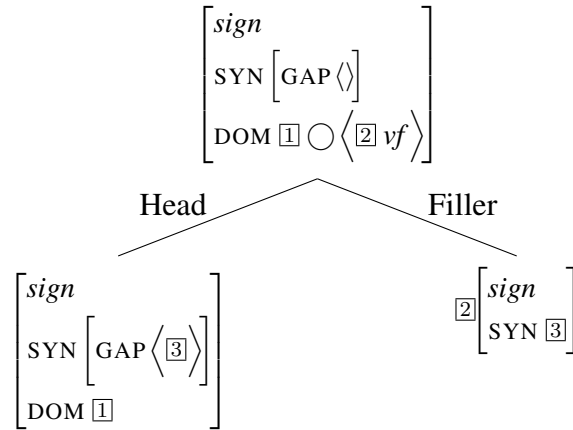

Figure 3.12: HEAD-FILLER SCHEMA with topological domains.

structure is licensed both by “combinatorial (internal, bottom-up) constraints and constructional (external, top-down)” statements (Kathol, 2000, 135). These two types of constructions interact to license complete clauses.

Most of the constructional constraints Kathol discusses constrain the linear properties of a clause, that is, they specify the orders of the domains as in (125). Here, the VERB-FIRST-CLAUSE CONSTRUCTION in (125a) licenses a clause which begins with a *cf* domain, while the VERB-SECOND-CLAUSE CONSTRUCTION in (125b) licenses a clause which begins with a *vf* domain. However, to license verb final word order, Kathol no longer references domains, but instead utilizes the fact that a *marked* clause, a common attribute within HPSG to designate a subordinate clause, contains a complementizer which consequently disallows the other two word orderings.

- (125) a. $v1\text{-clause} \Rightarrow \left[\text{DOM} \langle \textit{cf}, \dots \rangle \right]$
 b. $v2\text{-clause} \Rightarrow \left[\text{DOM} \langle \textit{vf}, \dots \rangle \right]$
 c. $\textit{subord-clause} \Rightarrow \left[\text{SYN} \left[\text{MARKING} \textit{marked} \right] \right]$

These constructions are part of the type hierarchy in Figure 3.13 for finite clauses. This hierarchy shows how every clause ultimately consists of a combination between INTERNAL-SYNTAX and SENTENCE-MODE CONSTRUCTIONS. The bottom row of the hierarchy contains all of the complete clause types for German which inherit interacting internal syntax (dashed line) and a

sentence mode (solid line) constraints. The different types of lines have no meaning and are simply for exposition purposes.

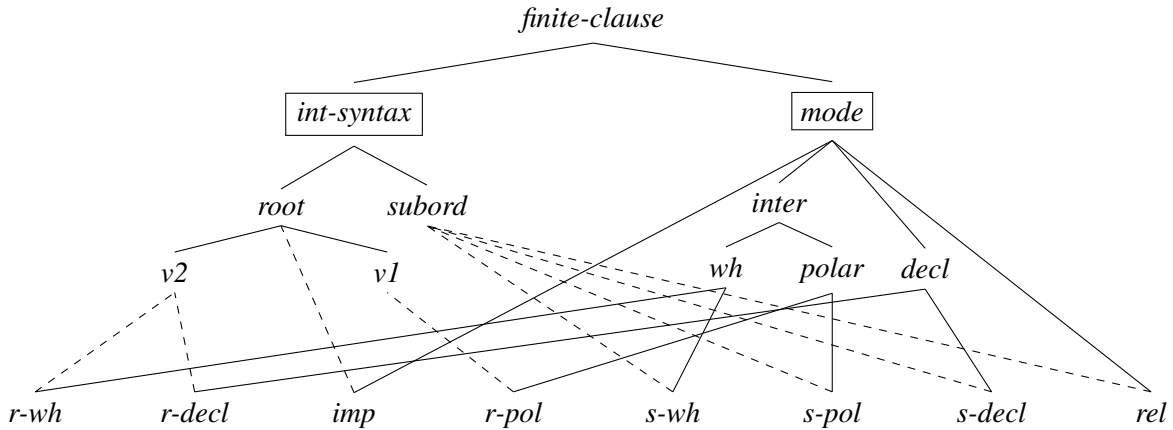

Figure 3.13: Hierarchy of clausal constraints for German

Both the V1 and V2-CLAUSE CONSTRUCTIONS inherit properties from the ROOT-CLAUSE CONSTRUCTION in (126a), which defines the properties of German main clauses. Moreover, the FINITE-CLAUSE CONSTRUCTION defines the properties of all finite clauses. All of these constructions directly specify the types and positions of domain elements.

- (126) a.
$$\text{root-clause} \Rightarrow \left[\begin{array}{l} \text{SYN} \quad \left[\text{CAT} \quad \boxed{1} \right] \\ \text{QSTORE} \quad \{ \} \\ \text{DOM} \quad \left\langle \dots, \left[\begin{array}{l} cf \\ \text{SYN} \quad \left[\text{CAT} \quad \boxed{1} \right] \end{array} \right], \dots \right\rangle \end{array} \right]$$
- b.
$$\text{finite-clause} \Rightarrow \left[\begin{array}{l} \text{SYN} \quad \left[\begin{array}{l} \text{CAT} \quad \left[\begin{array}{l} verb \\ \text{MOD} \quad /none \\ \text{VF} \quad \text{finite/tensed} \end{array} \right] \\ \text{VAL} \quad \langle \rangle \end{array} \right] \\ \text{DOM} \quad \left\langle \dots, cf, \dots \right\rangle \end{array} \right]$$

These syntactic constraints are then combined with sentence mode constraints, which interact with the semantics and pragmatics of the utterance as illustrated by (127). So, given the sentence mode of a particular clause, it is possible to predict its possible word orders. This corresponds to a characteristic of CxG where the semantics, that is the meaning, is directly associated with the

configuration of elements, the sign.

$$\begin{aligned}
 (127) \quad & \text{a.} \quad \text{declarative-clause} \Rightarrow \left[\begin{array}{l} \text{SYN} \quad \left[\text{CAT} \quad \boxed{2} \right] \\ \text{SEM} \quad \left[\text{MODE} \quad \textit{proposition} \right] \\ \text{DOM} \quad \left\langle \left[\text{SYN} \quad \left[\text{CAT} \quad \boxed{1} \right] \right. \right. \\ \quad \left. \left. \left[\text{WH} \quad \{ \} \right] \right], \dots \right\rangle \\ \boxed{1} \neq \boxed{2} \end{array} \right] \\
 & \text{b.} \quad \text{polar-clause} \Rightarrow \left[\text{SEM} \quad \left[\begin{array}{l} \text{MODE} \quad \textit{question} \\ \text{PARAMS} \quad \{ \} \end{array} \right] \right] \\
 & \text{c.} \quad \text{wh-interrogative-clause} \Rightarrow \left[\text{SEM} \quad \left[\begin{array}{l} \text{MODE} \quad \textit{question} \\ \text{PARAMS} \quad \textit{non-empty-set} \end{array} \right] \right] \\
 & \text{d.} \quad \text{relative-clause} \Rightarrow \text{subord-clause} \wedge \left[\begin{array}{l} \text{SYN} \quad \left[\text{CAT} \quad \left[\text{MOD} \quad \bar{n}_{\boxed{1}} \right] \right] \\ \text{DOM} \quad \left\langle \left[\text{WH} \quad \{ \textit{ref-param}_{\boxed{1}} \} \right], \dots \right\rangle \end{array} \right]
 \end{aligned}$$

In all, the syntactic and sentence mode constraints are combined and interact to license a complete clause. A root declarative clause, for example, is defined by combining the constraints of V2 word ordering and those of a semantically declarative statement as in (128a). Similarly, a German polar question is defined by verb initial word order and no missing arguments.

$$\begin{aligned}
 (128) \quad & \text{a.} \quad \textit{root-declarative-clause} \Rightarrow \textit{v2-clause} \wedge \textit{declarative-clause} \\
 & \text{b.} \quad \textit{root-polar-clause} \Rightarrow \textit{v1-clause} \wedge \textit{polar-clause}
 \end{aligned}$$

3.5.3 Topological Fields in Other Languages

Kathol (2000) discusses the ability to expand his topological analysis of German to other Germanic languages and suggests some necessary modifications. In order to apply this model to languages such as Yiddish or Icelandic, which have verb second subordinate clauses, and to Scandinavian, which places objects after the verb cluster, he modified the German TOPOLOGICAL LP STATEMENT to that in (129) which includes newly created *root complementizer* and *object field* domains.

$$\begin{aligned}
 (129) \quad & \text{MODIFIED TOPOLOGICAL LP STATEMENT (Kathol, 2000, 262)} \\
 & \textit{rc} \prec \textit{vf} \prec \textit{cf} \prec \textit{mf} \prec \textit{vc} \prec \textit{of}
 \end{aligned}$$

Under this extended analysis, finite verbs appear in the *cf* position for root clauses and in *vc* for subordinate clauses. For both types of clauses, any non-finite verbs and their objects, which Kathol assumes form a verb phrase, appear in the *of* position. This is unlike the German analysis where non-finite verbs appear in the *vc* position. Complementizers are placed in the *rc* field.

He concludes that a topological model may not be appropriate for all languages despite the insight it provides for Germanic languages, and he instead proposes:

... the option of a syntactic system that has as one of its components a linearly-defined level of organization that is in part independent of the combinatoric structure is well within the boundaries of what a possible human language can be. (Kathol, 2000, 285)

In fact, Borsley and Kathol (2000) extend Kathol's original analysis of word order using domains and topological fields to account for verb second in Breton. Unlike German, Breton places entire complex predicates into the second position, whereas German only places the finite verb in the second position and the other verbs in the *vc* field. In Borsley and Kathol's analysis of Breton, the topological fields are named as in (130) but are still equivalent to the corresponding fields in Kathol's analysis of German (cf. example (119)).

(130) *first* < *second* < *third* < *fourth* < *fifth* (Borsley and Kathol, 2000, 683)

Because complex predicates appear together in the second position, Breton does not require a *vc*, i.e. *fourth*, field. Thus, to describe Breton word order, only the *first*, *second*, and *third* fields are needed. To accommodate multiple elements in the *second* field, the TOPOLOGICAL CARDINALITY CONDITIONS (cf. example (124)) used for German must be revised to only restrict the *first* field.

Consider the sentence in (131). Here there is a complex predicate consisting of one finite and two non-finite verbs where all non-finite verbs are marked [LEX +]. A non-finite verb is underspecified as belonging to either the *first* or *second* topological field, thus allowing *kavet* 'found' to appear in the first position.

- (131) a. Kavet **am eus** bet al levr.
 found.PST.PTCP 1SG have.PRS. 1SG have.PST.PTCP the book
 'I have found the book.' *Breton* (Borsley and Kathol, 2000, 695)

b.
$$\left[\text{DOM} \left\langle \left[\begin{array}{c} \textit{first} \\ \langle \textit{kavet} \rangle \\ \text{V}[\textit{nfin}, \textit{LEX} +] \end{array} \right], \left[\begin{array}{c} \textit{second} \\ \langle \textit{am eus} \rangle \\ \text{V}[\textit{fin}] \end{array} \right], \left[\begin{array}{c} \textit{second} \\ \langle \textit{bet} \rangle \\ \text{V}[\textit{nfin}, \textit{LEX} +] \end{array} \right], \left[\begin{array}{c} \textit{third} \\ \langle \textit{al levr} \rangle \\ \text{NP} \end{array} \right] \right\rangle \right]$$
 (Borsley and Kathol, 2000, 697)

In a negated main clause in Breton, a non-finite verb may not appear in the first position, but any other non-verbal element may. So, Borsley and Kathol posit the implicational constraint in (132) which states that if a non-finite verb is in the first position, then the finite verb must not be negated.

(132)
$$\left[\text{root-decl} \left[\text{DOM} \left\langle \left[\begin{array}{c} \textit{first} \\ \text{V}[\textit{LEX} +] \end{array} \right], \dots \right\rangle \right] \right] \rightarrow \left[\text{DOM} \left\langle \left[\begin{array}{c} \textit{second} \\ \text{V}[\textit{FIN}, \textit{NEG} -] \end{array} \right], \dots \right\rangle \right]$$

Additionally, a topological analysis has been employed in other second position phenomena such as second position clitics in Serbo-Croatian. Penn (1999) developed a topological schema similar to the one for German except with language-specific modifications to account for the positioning of the cluster of clitics which appear after some initial constituent. However, Serbo-Croatian differs from V2 languages in that the second position clitics are not required. So, the topological fields for Serbo-Croatian represent linearization patterns rather than the anchoring of word order around a second position element.

3.6 The Role of the First Position

As described in §3.1, the transformational approaches assume movement to account for flexible word order, and in the case of V2 clauses, the movement of some element to the first position. This movement analysis to account for V2 word order was directly adopted by non-transformational frameworks under the guise of extraction or some long-distance dependency relationship to account for German clause structure. So, some type of movement has, in fact, remained a common

mechanism for modern constraint-based accounts of V2.

This type of approach begins with Uszkoreit (1987, 26–27), who investigated German clause structure. He characterized the first element of a V2 clause as possessing some sort of pragmatic emphasis either as a topic or having some contrastive or emphatic focus. Under this assumption, he treats the first element like topicalization in English, namely as a filler of a long-distance dependency. Furthermore, he follows Chomsky’s analysis that topicalization and *wh*-fronting are both products of this same type of movement. Thus, declarative V2 clauses, as well as content question clauses, are licensed by the extraction of some pragmatically marked element from a verb initial clause. This element is ensured to appear first before the embedded verb initial clause by a linear precedence rule which states that topicalized elements appear before anything else as in (133), thus ultimately producing V2 word order (Uszkoreit, 1987, 76).

(133) +TOP < X

This transformation-inspired analysis is subsequently taken up in later analyses in HPSG which model V2 word order with a similar extraction mechanism, as discussed in §3.4. That is, the typical extraction-based analysis posits some verb initial structure with an additional element licensed in the first position via a long-distance dependency. Kathol (2000) later employs a construction-based approach for describing the various clausal structures in German, which does not necessarily require a long-distance dependency for V2 word order. However, although Kathol does not explicitly commit to the use of a FILLER-HEAD SCHEMA to account for V2 word order, he still uses it because it makes no difference in his analysis. So, Kathol does not break from the traditional use of extraction for V2 order. In fact, he asserts this undecided stance when he considers V2 structures where the first position cannot be the result of a filler-head structure such as with the expletive *es* (Kathol, 2000, 149). Refuting such construction-based analyses which rely on shuffling, Müller (2005a) returns to extraction to model V2 clauses based on examples of embedded elements appearing in the first position of matrix clauses, as shown in (112).

However, evidence shows that the first position is not modeled by some pragmatic phenomenon, like topicalization, or a long-distance dependency. Furthermore, the first position does not have any special semantic properties that an extraction-based approach would predict. In this section, I

examine this evidence and show that the first position is syntactically no different than the rest of the clause. Apparent differences are simply correlations between information structure and linear order.

3.6.1 Information Structure

The first element preceding the second position verb is often attributed a particular discourse function such as topic or focus. The realization of particular elements in the first position is frequently named topicalization, as exemplified by the analysis proposed by Uszkoreit (1987). Joutiteau (2010, 206), in her overview of V2 languages, similarly states that '[t]he V2 preverbal area is far from neutral in terms of information packaging' but she asserts that 'both typological evidence and arguments internal to V2 languages show that it would be incorrect to conclude that information structure derives the V2 phenomena.' This conclusion is made due to the large variety of discourse-marked material that may appear in the first position as well as to the inconsistency in their patterns. Joutiteau provides three reasons for her conclusion. First, if the first position were reserved for a focused or topicalized element, then it becomes difficult to explain sentential focus. Second, an expletive such as *es* in German, which is semantically vacuous, can appear in this first position. Finally, in a neutral statement the first element has no special discourse status and is simply chosen by language-specific conventions: A neutral German sentence often begins with the subject whereas in Breton it begins with an infinitival verb.

Although information structure may not be responsible for the stipulation of one pre-verbal element, a high correlation between the first element and a discourse-marked status is often found, which is perhaps responsible for the confusion. For instance, consider the set of linear precedence rules in (134) that Uszkoreit (1987, 114) presents to describe the general word order tendencies of German, which are, however, not absolute. He develops a logic for such LP rules which allows any single rule to be violated as long as another rule 'legitimizes' the violation. Yet, despite this interplay of LP rules, they still indicate the overall word order tendencies. So, it can be concluded that subjects more frequently occur before dative and accusative objects. Similarly, non-focused elements (i.e. topics) occur more frequently than focused ones.

- (134) a. +NOM < +DAT
 b. +NOM < +ACC
 c. +DAT < +ACC
 d. -FOCUS < +FOCUS
 e. +PRONOUN < -PRONOUN

Assuming that the verbal arguments are realized within a structure where they are shuffled around a second position verb, from Uszkoreit's LP rules it then follows that topics and subjects (i.e. nominative objects) will more frequently appear before all other elements, which happens to be in the first position. Of course, this need not be the case as long as another LP rule legitimizes an alternative order. Yet, the tendencies for certain types of arguments to appear in particular orders could easily be confused as canonical features of certain clausal positions, such as the first position of a V2 clause. However, from such LP rules like Uszkoreit's, the discourse status of this position can be reduced to an epiphenomenon of other linear constraints.

3.6.2 Linear Phenomena

Kathol (2000, §6.5) also argues that there is no distinction between the first position of a V2 clause and the positions following the finite verb that can be attributed to structural or combinatorial properties. While he mainly seeks to disprove the use of transformational movement mechanisms to account for the first position, these arguments are also valid against approaches which require extraction to license an element in this pre-verbal location.³ Kathol reports on two phenomena which behave exactly the same regardless of being in a V2 or an embedded verb final clause without a "first position".

First, consider the readings of the two sentences in (135) where the object *mindestens eine Frau* 'at least one woman' must have a narrow scope reading if it occurs after the subject *viele Männer* 'many men' in (135a), as observed by Frey (1993). If these elements were to switch positions

³Although he argues that the first position is not unique from the rest of the clause, Kathol (2000) actually also uses extraction to account for the first position in his analysis. However, in his analysis word order is not necessarily dependent upon the extraction itself, rather word order is determined by the topological fields of the word order domains.

with the accusative object appearing before the subject as in (135b), then *mindestens eine Frau* may have scope over *viele Männer* in addition to the previous interpretation. Extraction-based approaches to V2, such as those discussed in §3.4, predict the interpretations where the filler in the first position scopes over the rest of the clause. But extraction-based approaches do not account for (135b) where *viele Männer* scopes over *mindestens eine Frau*. Furthermore, similar sentences, as shown in (136), may have the same orders of arguments but in subordinate clauses. These clauses do not have a “first position” and thus do not require fronting, yet they produce the same scopal readings as the V2 variants. So, Kathol (2000, 128) asserts that it is, in fact, the linear order of the quantifiers which matter and not “configurational notions” like fronting.

- (135) a. Viele Männer haben mindestens eine Frau hofiert.
 many men.NOM have.3PL.PRS at.least one woman.ACC court.PST.PTCP
 ‘For many men there is at least one woman that they courted.’
- b. Mindestens eine Frau haben viele Männer hofiert.
 ‘For many men there is at least one woman that they courted.’
or, ‘There is at least one woman such that many men courted her.’ *German* (Frey, 1993)
- (136) a. dass viele Männer mindestens eine Frau hofierten
 that many men.ACC at.least one woman.ACC court.3PL.PST
 ‘that for many men there is at least one woman that they courted’
- b. dass mindestens eine Frau viele Männer hofierten
 ‘that for many men there is at least one woman that they courted’
or, ‘that there is one woman such that many men courted her’ *German* (Frey, 1993, 181)

Similarly, weak cross-over effects are the same despite their presence or absence in a V2 clause. Consider the sentences in (137) and (138) which illustrate the relatively lax constraints of German, which unlike English do not as strictly dictate the order of coreferential elements. Here, *jeder* ‘everyone’ and *seine* ‘his’ may appear in any order and produce grammatical utterances.

- (137) a. dass jeder_i seine_i Kinder liebhat
 that everyone.NOM his children.ACC dear.have.3SG.PRS
 b. dass seine_i Kinder jeder_i liebhat

‘that everyone_i loves his_i children’ *German* (Lee and Santorini, 1994, 264)

- (138) a. Jeder_i hat seine_i Kinder lieb.
 everyone.NOM have.3SG.PRS his children.ACC dear
 b. Seine_i Kinder hat jeder_i lieb.

‘Everyone_i loves his_i children.’ *German* (Lee and Santorini, 1994, 276)

However, when the antecedent is no longer the subject of the sentence, one ordering of the elements becomes ungrammatical as shown in (139). And, once again, the same facts which hold for the verb final clause also hold for the V2 clause in (140).

- (139) a. dass jeden_i seine_i Kinder liebhaben
 that everyone.ACC his children.NOM dear.have.3PL.PRS
 b. *dass seine_i Kinder jeden_i liebhaben

‘that everyone_i is loved by his_i children’ *German* (Lee and Santorini, 1994, 260–1)

- (140) a. Jeden_i haben seine_i Kinder lieb.
 everyone.ACC have.3PL.PRS his children.NOM dear
 b. *Seine_i Kinder haben jeden_i lieb.

‘Everyone_i is loved by his_i children.’ *German* (Lee and Santorini, 1994, 275)

Thus, the same behavior between main and subordinate clauses for weak cross-over effects, as before, also shows that extraction to a first position cannot account for this phenomenon by readjusting syntactic structure. Instead, it simply seems to be the linear order of the elements which influences their acceptable readings. This means, as Kathol (2000) suggests, that there is no evidence for a special fronting mechanism.

3.6.3 Bounded Extraction

If the first element of a V2 clause were realized by extraction with something like a HEAD-FILLER SCHEMA, it is unclear what form this construction should take. The HEAD-FILLER SCHEMA subsumes a set of constructions typical of HPSG analyses, as illustrated in Figure 3.14, which allow

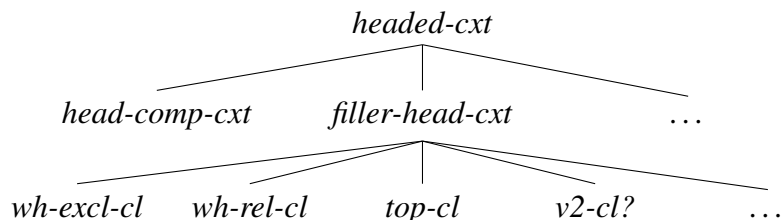

Figure 3.14: FILLER-HEAD CONSTRUCTIONS with unknown placement of a V2 CONSTRUCTION.

unbounded extraction, that is, the realization of arbitrarily embedded elements in an alternative location, usually clause initial. For example, non-subject *wh*-interrogatives in English are realized as a filler in the first position. However, none of these constructions appropriately predict V2 in all of its instances.

A TOPICALIZATION CONSTRUCTION, a type of extraction, does indeed allow V2 word order but also includes the corresponding prosodic and pragmatic information associated with topicalization. Such a construction which encodes pragmatic information could not apply to elements which inherently have no pragmatic emphasis, such as expletives. Additionally, topicalization allows elements to be extracted from embedded clauses. However, the expletive ‘*es*’ in German must appear locally in the first position as in (141a), and may not be topicalized to a matrix clause as shown in (141c).

- (141) a. *Es regnet in der Stadt.*
 EXPL rain.3SG.PRS in the city
 ‘It is raining in the city.’ *German*
- b. *[In der Stadt]_i sagt er, dass es _{-i} regnet.*
 in the city say.3SG.PRS he COMP EXPL rain.3SG.PRS
 ‘In the city, he said, that it’s raining.’ *German*
- c. **Es_i sagt er, dass _{-i} in der Stadt regnet.*

So, some V2-FILLER-HEAD CONSTRUCTION would need to be posited to allow V2 word order without any additional prosodic or pragmatic information. Additionally, because a first element must be realized clause internally (i.e. every V2-type clause, such as a main declarative clause in German, must have an element in the first position), this V2-FILLER-HEAD CONSTRUCTION would need to be constrained so that the filler could not cross clausal boundaries and would in

fact be a bounded dependency that is realized locally. Such constraints are clearly very different from those of the TOPICALIZATION CONSTRUCTION. Thus, a HEAD-FILLER SCHEMA approach would require the definition of *at least* two nearly identical constructions creating a more complex analysis of V2 word order.

Furthermore, in order to realize an extracted element from an embedded clause to the first position of a matrix clause, such as in (141b), the element must have strong pragmatic emphasis. This supports the use of some TOPICALIZATION CONSTRUCTION to license such an utterance, but it also accentuates the differences between this type of extracted first position and a clause-internal first position which may be pragmatically neutral.

3.7 Putative Evidence for V2 via Extraction

Certain syntactic phenomena have been used as evidence for extraction when licensing the first element of a V2 clause. I will briefly consider the relevant evidence in the next two sections and show that it does not in fact indicate the necessity of extraction for local first elements.

3.7.1 Wh-Interrogatives

Flexible word order allows the arguments in a clause to be realized in a variety of orders so that all the arguments may appear in the first position, as illustrated by the German sentence in (142). But, the wh-interrogatives canonically appear in the first position as described in Chapter 2.

- (142) a. Er **erzählt** seiner Tochter ein Märchen.
 he tell.3SG.PRS his.DAT daughter a fairy.tale
 b. Ein Märchen **erzählt** er seiner Tochter.
 c. Seiner Tochter **erzählt** er ein Märchen.

‘He is telling his daughter a fairy tale.’ *German*

This wh-interrogative positioning is like English, which because of its strict SVO word order, requires extraction in order to realize non-subject arguments in the first position. For instance, consider the English sentences in (143). The subject wh-interrogative in (143b) exhibits the same word order as the first sentence, namely SVO. However, the object wh-interrogative sentence in

(143c) does not exhibit the same word order and requires that *what* be extracted to the front of the clause.

- (143) a. The man read a book.
 b. Who read a book?
 c. What did the man read?

German, however, does not require extraction to allow this alternate word order. Rather, because German has flexible word order, the *wh*-interrogatives could be analyzed as in-situ *wh*-words which are just restricted to the first position as illustrated by the examples in (144) which reflect the word orderings in (142).

- (144) a. *Wer erzählt seiner Tochter ein Märchen.*
 who.NOM tell.3SG.PRS his.DAT daughter a fairy.tale
 ‘Who is telling his daughter a fairy tale?’
 b. *Was erzählt er seiner Tochter.*
 what tell.3SG.PRS he his.DAT daughter
 ‘What is he telling his daughter?’
 c. *Wem erzählt er ein Märchen.*
 who.DAT tell.3SG.PRS he a fairy.tale
 ‘Who is he telling a fairy tale?’ *German*

This in-situ analysis is comparable to subject *wh*-interrogatives in English, which also might not required any sort of displacement to alter word order. However, it has been argued that there is cross-linguistic evidence which indicates that all *wh*-interrogatives, even subject ones, are reflected in the morpho-syntax as extraction phenomena (Hukari and Levine, 1995; Bouma et al., 2001; Levine and Hukari, 2006, *inter alia*), thus suggesting that first elements should also be extracted in all cases. I reconsider some of this cross-linguistic evidence in the following sections and show that in local contexts, the evidence, in fact, does not indicate that extraction is utilized. Thus, local first elements should not be analyzed as long-distance dependencies.

3.7.1.1 Yiddish wh-interrogatives

A further examination of Yiddish wh-interrogatives actually shows that they must not participate in extraction in simple local environments, as is usually presumed. If one were to accept the evidence that all wh-interrogatives are extracted, it would suggest that the Yiddish wh-interrogative *ver* ‘who’ in example (145) is an extracted element. Those who favor extraction-based analyses would then reason that because *ver* is in the first position, it must contain an extracted element.

- (145) Ver **hot** gegesn dos broyt?
 who.NOM have.3SG eat.PST.PTCP the bread
 ‘Who ate the bread?’ *Yiddish* (Diesing, 1990, 52)

Like main clauses, subordinate clauses in Yiddish also have V2 word ordering. For instance, the sentence in (146) contains a subordinate clause where *Max* is in the first position. Here, the wh-interrogative *vos* ‘what’ could legitimately be analyzed as an extracted complementizer and does not occupy the first position of this V2 clause. So, if the first position must contain an extracted element, then it seems that *vos* would naturally occupy the position, but this is not the case because *Max* is in the first position. Instead *vos* has been linearized outside of the V2 word order constraints as a complementizer.

- (146) Ikh veys nit [vos Max **hot** gegesn].
 I know.1SG not what Max have.3SG eat.PST.PTCP
 ‘I don’t know what Max ate.’ *Yiddish* (Diesing, 1990, 68)

Furthermore, when there is no object to fill the first position of an embedded V2 clause, then the expletive *es* must be used. Consider the sentences in (147a) which contain embedded V2 clauses with the subject wh-interrogative *ver*. Here the only valid option is to insert *es* into the first position as *ver* may not occupy this spot. This indicates that the first position is, in fact, excluding extracted elements from the first position.⁴ Consequently, the first position does not host extracted elements, and the subject wh-interrogative in (145) cannot be an extracted element.

⁴More specifically, this evidence only indicates that locally extracted elements cannot appear in the first position. There is still evidence that elements extracted from embedded clauses may appear in the first position of a matrix clause. See §5.7 for further discussion.

- (147) a. Ikh veys nit [ver es **iz** gekumen].
 I know.1SG not who.NOM EXPL be.3SG come.PST.PTCP
 b. *Ikh veys nit [ver **iz** gekumen].

‘I don’t know who came.’ *Yiddish* (Diesing, 1990, 68)

3.7.1.2 Local wh-interrogatives

Often the analyses of English wh-interrogatives, which utilize extraction, are directly transferred to flexible word order languages, like German. In such analyses, extraction is necessary to allow alternate word orders. However, this is not necessary in a flexible word order language which already allows variable word order realizations. So, the linear properties of this phenomenon are actually not comparable between language types, yet in-situ wh-interrogatives are.

Usually wh-interrogatives appear as the first element in an English clause, but in certain contexts, the interrogative may appear in the exact position where its non-interrogative component would appear. Ginzburg and Sag (2000) describe two types of English in situ wh-phrases: reprising interrogatives, such as the one in (148) where the wh-interrogative echos the corresponding NP, and non-reprising interrogatives, like the examples in (149), which require particular discourse-pragmatic contexts.

- (148) a. Jo saw absolutely every shaman priest from East Anglia.
 b. Jo saw WHO? (Ginzburg and Sag, 2000, 270)
- (149) a. A. Well, anyway, I’m leaving.
 B. OK, so you’ll be leaving WHEN exactly?
 b. A. I’m annoyed.
 B. Aha. You’re annoyed with WHOM? (Ginzburg and Sag, 2000, 280)

Ginzburg and Sag (2000) provided a detailed analysis of English interrogatives where they utilize the HEAD-FILLER CONSTRUCTION to account for normal clause initial wh-interrogatives. However, they do not analyze in-situ wh-interrogatives with the HEAD-FILLER CONSTRUCTION. Instead, according to them, in-situ interrogatives are not licensed by extraction, rather they are

directly realized in their usual position in a clause. This same analysis may be applied to German in-situ interrogatives as shown in (150). In this example, the interrogative *wer* does not appear in the usual first position but instead in a mid-clause position.

- (150) A. Die arme Frau. Jetzt **nehmen** sie ihr auch noch das Haus weg.
 the poor woman now take.3PL they she.DAT also still the house away
 ‘The poor woman. Now they’re also taking her house away from her.’
- B. Mal langsam. Jetzt **nimmt** ihr WER das Haus weg?
 PRT slowly now take.3SG she.DAT who.NOM the house away
 ‘Slow down. WHO is taking her house away from her now?’ *German* (Reis, 1992, 222)⁵

The more usual word order for this German question would take the form of the clause in (151A) with *wer* in the first position. The declarative sentence in (151B) then matches the word order of this question. So, the two declarative clauses in (150A) and (151B), both of which are alternate word orders of the same sentence, do not require extraction to realize the position of their elements. The word orders of these two declarative clauses are exactly the same as the interrogative variants in (150B) and (151A). So, it seems reasonable that the syntax of these interrogative clauses can both be realized without extraction. It is not clear why only the in-situ variant in (150B) should not require extraction, but the also arguably in-situ first position interrogative in (151A) does.

- (151) A. Wer **nimmt** ihr jetzt das Haus weg?
 who.NOM take.3SG she.DAT now the house away
 ‘Who is taking her house away from her now?’
- B. Sie **nehmen** ihr jetzt das Haus weg.
 they take.3PL she.DAT now the house away.
 ‘They’re taking her house away from her.’ *German*

Thus, because German, a flexible word order language, already allows the realization of clausal arguments in various configurations, there is no need to stipulate that a further mechanism, like extraction, also allows alternate word order for only first position wh-interrogatives. So, local wh-interrogatives in flexible word order languages need only be treated as in-situ, like other in-situ

⁵Translations added.

wh-languages like Japanese. In this analysis, extraction phenomena are assumed to only occur in non-local dependencies (i.e. those that cross a clausal domain), as discussed in §5.7.

3.7.2 Discontinuous NPs

In some instances, a prepositional phrase and the noun phrase it modifies may appear discontinuously as illustrated in (152). Often this phenomenon is modeled with extraction: The prepositional phrase *über Syntax* ‘about Syntax’ is extracted out of the noun phrase *ein Buch über Syntax* ‘a book about syntax’ to the front of the clause. Because the whole noun phrase *ein Buch über Syntax* must behave as a single unit under a shuffling analysis, there is no way the embedded PP could be shuffled independently to the front of the clause. Thus, it would seem that extraction is necessary. If this is indeed the case and extraction is used in this phenomenon, then verb second placement would be a natural result of the fronting of a single element in an underlyingly verb initial phrase. This is the type of reasoning used to justify extraction-based analyses (cf. Müller, 2005a). However, there is evidence that extraction is, in fact, not responsible for discontinuous NPs in German, which no longer makes this fronting mechanism a natural candidate for licensing V2 clauses and supports a flat shuffling-based analysis.

- (152) a. *Über Syntax hat* er sich [ein Buch] ausgeliehen.
 about syntax have.3SG.PRS he himself a book borrow.PST.PTCP
 b. [Ein Buch] *hat* er sich *über Syntax* ausgeliehen.

‘He borrowed a book about syntax.’ *German* (De Kuthy, 2002, 5,7)

De Kuthy (2002) provides an in-depth analysis of discontinuous NPs and concludes that extraction is not the appropriate analysis for this phenomenon. Instead, De Kuthy argues for a reanalysis approach. First, consider the alternative realization in (152b) of the previous discontinuous NP example. Here, the noun phrase *ein Buch* appears in the first position while the preposition phrase *über Syntax* appears later in the clause. It is easy to explain the first example in (152a) as extraction from a complex noun phrase, but it is unclear how the head noun phrase could be extracted from the full phrase *ein Buch über Syntax*, thus leaving its modifying PP behind.

Moreover, no component of a discontinuous NP may appear in the first position, rather both NP and PP subparts may, in fact, appear after the finite verb as illustrated in (153). This word order placement would require extraction to a location in the middle of the clause rather than the beginning, which is not the intended function of extraction.

- (153) a. Hans **hat** schließlich [drei Bücher] bei Osiander *über Syntax*
 Hans have.3SG.PRS finally three books at Osiander about syntax
 gekauft.
 buy.PST.PTCT
 b. Hans **hat** schließlich *über Syntax* bei Osiander [drei Bücher] gekauft.

‘Hans has finally bought three books about syntax at Osiander.’ *German* (De Kuthy, 2002, 68)

Finally, the data shows more complex behavior in regards to partial verb phrase fronting in (154). Not only is the NP discontinuous, but the sub-NP appears with the non-finite verb as a partial verb phrase in the first position. However, the PP may not appear in a partial verb phrase. Extraction clearly does not account for such data.

- (154) a. [Ein Buch ausleihen] **will** niemand über Syntax.
 a book borrow.INF want.3SG.PRS nobody on syntax
 b. *[Über Syntax ausleihen] **will** niemand ein Buch.

‘Nobody wants to borrow a book about syntax.’ *German* (adapted from De Kuthy, 2002, 68–69)

De Kuthy (2002) therefore concludes that an extraction-based analysis is dispreferred and instead proposes a reanalysis approach in which a complex NP constituent containing an NP and a PP may be viewed as two separate constituents free to be realized separately in a clause, which accounts for all of the phenomena above. This reanalysis process includes a quasi argument composition approach in which the sub-NP combines with the verb and raises its argument, the PP. Thus, because extraction is not needed and is also unable to account for such discontinuity, this mechanism is not a clear requirement for the licensing of first position elements and consequently V2 word order.

3.8 Summary

The approaches for handling flexible word order range from directly describing the possible clausal elements and their word orders to heavily modifying underlying structures with movement. The previous sections addressed various approaches along this spectrum as well as the role of extraction, particularly in licensing the first position of a V2 clause:

§3.1 Mainstream Chomskyan syntactic theory posits that all phrase structure is binary, and in order to account for flexible word order, it must assume tree structures can be restructured. Generally, in order to account for V2 and flexible word order, multiple elements in this underlying binary tree are moved to the front of the structure, as allowed by general rules and principles.

§3.2 Movement-based analyses posit unobservable structures to model syntactic structure, which often lack empirical support. However, psycholinguistic evidence indicates that utterances are processed incrementally word-by-word and incorporate multiple types of information in parallel, without any evidence of tree-restructuring operations. Constraint-based grammars, like HPSG, are more compatible with incremental sentence comprehension and production evidence, because such approaches to grammar are more surface-driven.

§3.3 Constraint-based approaches, like HPSG, are surface-oriented in the sense that the grammar rules are directly informed by the observable empirical patterns rather than by theoretical assumptions. SBCG combines insights from HPSG and CxG into the same formalism, particularly to model the rich interaction of constructions.

§3.4 Extraction phenomena are modeled by a GAP feature, whose value is percolated in subsequent constructions until an appropriately matching, often non-local phrase is found and licensed by a FILLER-HEAD CONSTRUCTION. Extraction-based analyses account for V2 word order by positing that some element is extracted from a verb initial clause to the first position. Moreover, the verb initial clause is first licensed from a basic verb final order with a feature like INVERTED.

§3.5 Syntactic structure is separated from surface word order with liberation and word order domains. Independent of any combinatorial structures, domain elements are collected as syntactic rules are applied. The final word order of an utterance is determined by some allowable order of these domain elements which is constrained by linear precedence rules. Traditional topological fields were modeled using domain elements to account for V2 word order, particularly for German, but require modification for other languages. Linear constructions directly define the order of domain elements, which then interact with other constructions to license full utterances.

§3.6 Extraction has been the preferred mechanism to account for the first position of a V2 clause in other analyses. However, evidence shows that the first position is not modeled by a long-distance dependency, is not necessarily pragmatically prominent and, in fact, exhibits the same semantic properties as other non-verbal positions.

§3.7 First position wh-interrogatives and discontinuous noun phrases putatively indicate the need for an extraction-based analysis. However, the data show that wh-interrogatives in flexible word order languages, in fact, share properties with in-situ wh-interrogatives and that discontinuous noun phrases are better analyzed with a reanalysis approach. Both phenomena do not require extraction.

I advocate the use of constructions which directly characterize the structure of an utterance providing the most descriptive approach to flexible word order. Moreover, such constructions are in principle psychologically plausible and consistent with what is known about human language processing. Despite the rejection of a long-distance dependency to license V2 word order, such a dependency is still warranted in instances when a constituent must be freed from an embedded clause, which may then shuffle under normal circumstances in a matrix clause. But this mechanism is not appropriate as the sole method for fronting a particular element and consequently producing V2 word order.

Having shown that an extraction-based analysis of flexible word order is undesirable and that it is possible to directly model linearization phenomena without appealing to covert operations, I

provide two construction-based analyses in the following chapters. These analyses directly specify the linear properties of a clause. First, I will describe a cross-linguistic analysis of V2 word order in Chapter 4 that follows the spirit of the domain-based account provided by Kathol (2000), but instead I will not make use of extraction or the topological fields. Then, having shown that word order can be directly modeled in a familiar domain-based analysis, I describe a flat construction-based account of German clause structure in Chapter 5 which dispenses with deeply embedded phrase structure and domains. Instead, this flat analysis defines constructions which directly characterize the linear and combinatorial constraints of clauses while correctly accounting for other syntactic properties and phenomena.

Chapter 4

Cross-linguistic Word Order Domains

The domain-based approaches to syntax model surface word order and the underlying combinatorial structures with separate yet interacting mechanisms. This allows for insights from observable word order patterns to be directly encoded as constructions without extensive change to other syntactic structures, as exemplified by Kathol's analysis in §3.5. In a similar manner, I show that the observable cross-linguistic word order patterns of V2 languages may be formalized with the same set of mechanisms while allowing for flexible word order.

This generalized analysis draws from typed domains (i.e. TOPO) as described by Kathol (2000) and the constructional description of clauses as a combination of internal syntax and sentence mode. In fact, the analysis here is similar in spirit to Kathol's except I do not utilize the complex traditional topological fields or extraction. So, this cross-linguistic analysis can be viewed as a further development of Kathol's original construction-based analysis and a step towards surface-based approaches.

Thus, in this chapter I show that:

- Flexible and V2 word order can be formalized without extraction, that is, without a long-distance dependency relationship in local contexts.
- A minimal set of constructions accurately describe all V2 languages.
- Word order can be modeled in a surface-oriented manner by constructionally specified constraints.

In §4.1, I review the role of traditional topological fields. In §4.2, I describe the generalized mechanisms necessary for a construction-based analysis of V2 word order: (1) a simple two-valued feature rather than many-typed topological domain elements, (2) domain compaction, and (3) constructionally-determined domain positions. Then, in §4.3 I will outline grammar fragments for German, Breton, and Kashmiri to illustrate how these mechanisms license clause structure in V2 languages.

4.1 Topological Fields Revisited

Drawing from traditional grammar, the topological field model provides a time-tested way to describe the word order of German, as described in §3.5. But this model becomes problematic when it is applied to other languages. I will briefly outline some of the problems of a German-based topological field model as applied to other V2 languages which illustrates its inflexibility to be used as a generalized, cross-linguistic model. The sentences in (155) and their German topological fields in Figure 4.1 are repeated here to aid in the discussion.

- (155) a. ... dass er das Buch **kennt**.
 COMP he the book know.3SG
 ‘...that he knows the book.’
- b. **Kennt** er das Buch?
 ‘Does he know the book?’
- c. Das Buch **kennt** er.
 ‘He knows the book.’ *German*

Vorfeld	Comp. Field	Mittelfeld	Verb Cluster	Nachfeld
das Buch	kennt	er		
	kennt	er das Buch		
	dass	er das buch	kennt	

Figure 4.1: German topological fields.

First, the topological field model posits a complementizer field (*cf*) which may host a complementizer or finite verb, but not both. Thus, there is competition for this field by both elements,

which accounts for the respective orders in root and subordinate clauses: If a complementizer is present, the finite verb is forced to the end of the clause to the verb cluster (*vc*). However, unlike asymmetric languages like German, symmetric languages such as Yiddish or Kashmiri do not have this competition. Rather these languages allow both the presence of a complementizer and a second position verb. Additionally, some of the languages possess no subordinator in complement clauses as shown in §2.2.1, e.g. Breton and Karitiâna, rendering it even harder to justify competition for the *cf* position. Thus, the generalized analysis that I propose does not posit any such competition.

Next, not all V2 languages have the traditionally described *Verbalklammer* ‘verbal brackets’, which refer to the left finite verb and right non-finite verbs enclosing all of the verbal arguments, as described in §2.5. Karitiâna and Breton maintain a linearly contiguous verb phrase that never separates and appears as a *Verbalklammer*. Thus, the finite verb position, which is traditionally reserved for one word, can also accommodate multiple words. As described in §3.5.3, Borsley and Kathol (2000) achieve such a multi-word verb position by eliminating the requirement that the second position only contain one domain element, thus allowing all verbal domains to be placed in this position. Such languages also always have contiguous verbal elements so that the *vc* field is no longer necessary, thus changing the topological field structure needed for Karitiâna and Breton.

Furthermore, the right portion of the *Verbalklammer* may not be the far right edge of the utterance, excluding extraposed items. Namely, Yiddish allows verbal arguments to appear after the *cf* position and no longer maintains a final right verb cluster. In fact, the order of the elements appearing after the second position finite verb varies from language to language and does not necessarily exhibit identical behavior. So, it seems that the orders of these post-finite-verb elements are stipulated by language-dependent rules and should not be included in a universal topological model.

In all, the use of topological models to stipulate the position of classes of words cannot be generalized across V2 languages. Instead every language would necessitate its individual set of topological fields. Additionally, the topological fields themselves are construction-like in that they directly stipulate the patterns in which clausal elements are found. Thus, these linear configurations can easily be reinterpreted as constructions, the approach explored in this chapter.

4.2 Generalized Mechanisms

Conceptually, the generalized analysis I propose here places all constituents of a clause into a *word order domain*. There are only two types of word order domains, that is, two topological fields: *flexible* and *fixed*. Domain elements which are *flexible* may shuffle, via Reape's shuffle operator '○', and produce a variety of word orders from a single set of domains. Alternatively, constructions may place positional restrictions on particular domain elements by specifying that they are *fixed* and stipulating their linear position within a clause. Linear precedence rules may only affect *flexible* domain elements and do not interact with *fixed* elements. In this way, free word order and strict positional stipulations may simultaneously exist within a single clause. Thus, a V2 construction would specify that the finite verb is *fixed* and must appear in the second position. All other *flexible* elements may then shuffle around this *fixed* verb, which is exempted from linear precedence constraints.

The exclusive use of constructions and domains replaces features such as INITIAL to reduce redundant formal machinery and to motivate V2 word order. Similarly, I do not include extraction via a GAP feature to explain the placement of an element into the first position. Consequently there are no traces and no FILLER-HEAD CONSTRUCTION needed to describe V2 word order. Rather, word order is controlled exclusively through domains and linear precedence (LP) rules. I dispense with the traditional topological fields.

4.2.1 Two-typed Domain Elements

Domains, originally proposed by Reape (1994; 1996), provide the basic building blocks for a linearization-based approach to clausal word order. In addition to the existing attributes for an HPSG *sign* (e.g. PHON, SYN, and SEM), he adds the DOM attribute, as illustrated in (156), which is a list of domains that are structure shared with the *sign*'s complements. That is, the domain list is a list of *signs*. The *Constituent Ordering Principle* (Reape, 1994, 155) stipulates that the phonology of a *sign* is the concatenation of the phonology of its domains. Because the generalized V2 analysis is formulated in SBCG, this ordering principle has been slightly modified to fit the updated definition of a *sign* which employs a FORM feature in combination with PHON. The PHON

feature represents the phonological structure (e.g. /læft/), whereas the FORM feature contains the morphemes from which the phonological realization is derived (e.g. ⟨laugh+ed⟩) (Boas and Sag, 2012). So, while it is appropriate to concatenate the values of FORM, coarticulation and intonational phrasing phenomena, which are beyond the scope of this dissertation, may further modify the values of PHON beyond simple concatenation. For the purposes here, it suffices to assume that a *sign*'s FORM value is the concatenation of the FORM values of its domain elements, as formalized in (157).

$$(156) \quad \text{sign} : \left[\begin{array}{ll} \text{PHON} & \textit{phonological-object} \\ \text{FORM} & \textit{morphological-object} \\ \text{SYN} & \textit{syntactic-object} \\ \text{SEM} & \textit{semantic-object} \\ \text{DOM} & \textit{list(sign)} \end{array} \right]$$

$$(157) \quad \text{sign} \Rightarrow \left[\begin{array}{ll} \text{FORM} & L_1 \oplus L_2 \oplus \dots \oplus L_n \\ \text{DOM} & \left\langle \left[\text{FORM } L_1 \right], \left[\text{FORM } L_2 \right], \dots, \left[\text{FORM } L_n \right] \right\rangle \end{array} \right]$$

Unlike previous analyses I do not make use of topological fields to assign words to particular regions of a clause. Rather, constructions designate the positions of particular domains in a clause, notably the finite verb in a verb second clause, while allowing the other domains to shuffle according to language-specific LP rules. This division allows for the common clausal stipulations across all V2 languages while also allowing language-dependent linear orders.

In order to facilitate the division between *flexible* and *fixed* domain elements, I introduce a new attribute LIN with *linearization* values: *flexible* and *fixed*, as depicted in (158). This LIN attribute is part of a domain *sign*.

$$(158) \quad \begin{array}{c} \textit{linearization} \\ \swarrow \quad \searrow \\ \textit{flexible} \quad \textit{fixed} \end{array}$$

Linear precedence rules may only affect domain elements with a LIN value of *flexible*, as illustrated by the sample LP rule in (159). This allows *fixed* domain elements to remain in a constructionally-determined position without affecting the placement of the other *flexible* elements.

$$(159) \begin{bmatrix} \text{LIN} & \textit{flexible} \\ \text{FOCUS} & - \end{bmatrix} \prec \begin{bmatrix} \text{LIN} & \textit{flexible} \\ \text{FOCUS} & + \end{bmatrix}$$

4.2.2 Domain Compaction

Following Reape (1994; 1996), there are two kinds of DOMAIN CONSTRUCTIONS: LIBERATING, which keeps the daughter domain elements of a construction independent in the mother, and COMPACTING, which, like Kathol and Pollard (1995) and Donohue and Sag (1999), creates a *single* new domain element in which all the daughter domain elements may still shuffle. Compaction allows LP rules to still affect the order of the domain elements in the mother's domain, but forces them to act as a single unit in any further construction. Thus, the compacting mechanism enables multiple elements, when appropriate and specified by language-specific constructions, to form a single domain element which may appear in a single constructionally-determined domain position. This allows, for example, partial verb phrases in German to appear in the first position in a single *flexible* domain, or complex predicates in Breton to appear second in the single *fixed* finite verb domain.

$$(160) \text{ a. } \begin{array}{l} \textit{liberating-domain-cxt} \Rightarrow \left[\begin{array}{l} \text{MTR} \quad \left[\text{DOM} \quad L_1 \circ \dots \circ L_n \right] \\ \text{DTRS} \quad \left\langle \left[\text{DOM} \quad L_1 \right], \dots, \left[\text{DOM} \quad L_n \right] \right\rangle \end{array} \right] \\ \\ \text{ b. } \begin{array}{l} \textit{compacting-domain-cxt} \Rightarrow \left[\begin{array}{l} \text{MTR} \quad \left[\text{DOM} \quad \left\langle \left[\text{DOM} \quad L_1 \circ \dots \circ L_n \right] \right\rangle \right] \\ \text{DTRS} \quad \left\langle \left[\text{DOM} \quad L_1 \right], \dots, \left[\text{DOM} \quad L_n \right] \right\rangle \end{array} \right] \end{array} \end{array}$$

Compaction allows the definition of linear constituents which may not correspond to the phrase structure. This distinction, often described as the phenogrammatical and tectogrammatical levels of syntax (Curry, 1961; Dowty, 1996), is particularly salient with partial compaction (Kathol and Pollard, 1995; Yatabe, 1996), a mixture of the liberating and compacting domain constructions where only some of the daughter domains are compacted. This type of compaction is further explored in §4.3.1.

4.2.3 Cross-linguistic Constructions

Drawing from the constructional approach taken by Kathol (2000, Ch.7), the analysis here similarly constrains clauses by a combination and interaction of *linear* and *sentence mode* constructions. Using the attested linearization patterns in V2 languages, I propose a general set of common clausal constructions for word order determination, provided in Figure 4.2, which describe the mutually occurring syntactic constraints in all V2 languages. The *sentence mode* constructions license various clause types such as declarative, relative, and interrogative. And as illustrated in §2.2, the clause type patterns the position of the finite verb in a clause, thus making the *sentence mode* a necessary component when specifying linear order. Each language independently stipulates the combination of *linear* and *sentence mode* constructions which license a complete clause.

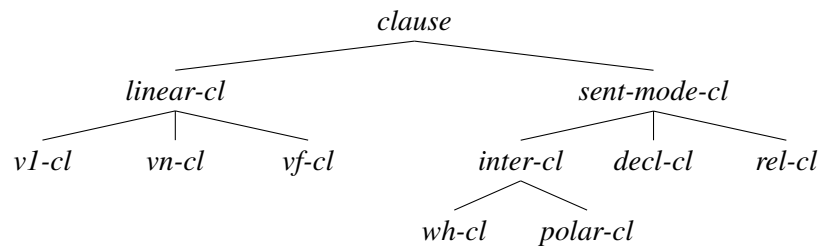

Figure 4.2: Hierarchy of clausal constraints common to all V2 languages.

The linear clause constraints are formally defined by the rules in (161)–(163). Each of these constructions explicitly states the location of the domain for the finite verb. The V1 and VF-CLAUSE CONSTRUCTIONS straightforwardly stipulate that the domain element with the *finite* V(ERB)F(ORM) must appear either clause initially or finally, respectively. Notice that the finite verb domain element is constructionally stipulated to be *fixed* and may be a phrase, that is, a complex predicate.

- (161) a. In a verb initial clause, the domain element with the finite verb appears *before* all other domain elements.

b.

$$v1-cl \Rightarrow \left[\text{MTR} \left[\text{DOM} \left\langle \left[\begin{array}{l} \text{LIN} \\ \text{SYN} \end{array} \right] \begin{array}{l} \textit{fixed} \\ \left[\text{CAT} \left[\text{VF} \textit{finite} \right] \right] \end{array} \right\rangle \oplus \textit{list} \left(\left[\text{LIN} \textit{flexible} \right] \right) \right] \right]$$

(162) a. In a verb final clause, the domain element with the finite verb appears *after* all other domain elements.

$$b. \quad vf-cl \Rightarrow \left[\text{MTR} \left[\text{DOM} \quad list\left(\left[\text{LIN} \quad flexible \right]\right) \oplus \left\langle \left[\begin{array}{l} \text{LIN} \quad fixed \\ \text{SYN} \quad \left[\text{CAT} \quad \left[\text{VF} \quad finite \right] \right] \right] \right\rangle \right] \right]$$

The VN-CLAUSE CONSTRUCTION in (163) must not only specify the position of the finite verb domain element, but must also limit the number and types of elements that precede it so that V2 or V3 may be realized. In the absence of any other constructions to specify *fixed* domain elements before the finite verb, only one element appears before the verb, namely a *flexible* element, thus creating V2 word order. If there is an additional construction specifying *fixed* elements before the finite verb, it then becomes possible to define V3 word order or, for that matter, V4, V5, and so on. The VN-CLAUSE CONSTRUCTION is remarkable in that it licenses all placements of the finite verb in some *n*th position from the beginning of a clause in exactly the same way.

(163) a. In a Vn clause, the finite verb domain is preceded by exactly one *flexible* domain element and any number of *fixed* domain elements, in any order, and followed by any number of *flexible* domains.

$$b. \quad vn-cl \Rightarrow \left[\text{MTR} \left[\text{DOM} \quad \left(list\left(\left[\text{LIN} \quad fixed \right]\right) \circ \left\langle \left[\text{LIN} \quad flexible \right] \right\rangle \right) \oplus \left\langle \left[\begin{array}{l} \text{LIN} \quad fixed \\ \text{SYN} \quad \left[\text{CAT} \quad \left[\text{VF} \quad finite \right] \right] \right] \right\rangle \oplus list\left(\left[\text{LIN} \quad flexible \right]\right) \right] \right]$$

Following the discussion in Chapter 3, a FILLER-HEAD CONSTRUCTION and GAP feature are not utilized to model the appearance of an element before a finite verb in a VN-CLAUSE CONSTRUCTION. Previous analyses used these mechanisms to move an element before the finite verb or to change the topological field of a particular element so that the LP rules would force its realization in the first position. But, as previously discussed, an extraction mechanism is not motivated by empirical evidence. For this reason, the VN CLAUSE CONSTRUCTION alone allows the shuffling of a *flexible* domain before the finite verb.

Finally, for all V2 languages which attest complementizers, these elements are not shuffled with a clause’s word order domains and must instead be positionally constrained by the COMPLEMENTIZER CONSTRUCTION in (164), which is similar to the HEAD-FUNCTOR CONSTRUCTION in SBCG. This construction concatenates a *fixed* complementizer domain to the beginning of a saturated clause’s domain list. Here, SELECT indicates which expression the complementizer modifies, following Sag (2012). Thus, the correct position of the complementizer is specified without interfering with a clause’s word order. This separate COMPLEMENTIZER CONSTRUCTION is posited in order to avoid overgeneralizing the values of the LINEARIZATION features in other HEAD-FUNCTOR CONSTRUCTIONS.

(164) a. A complementizer clause consists of a *fixed* complementizer which selects and precedes a saturated clause and its domains.

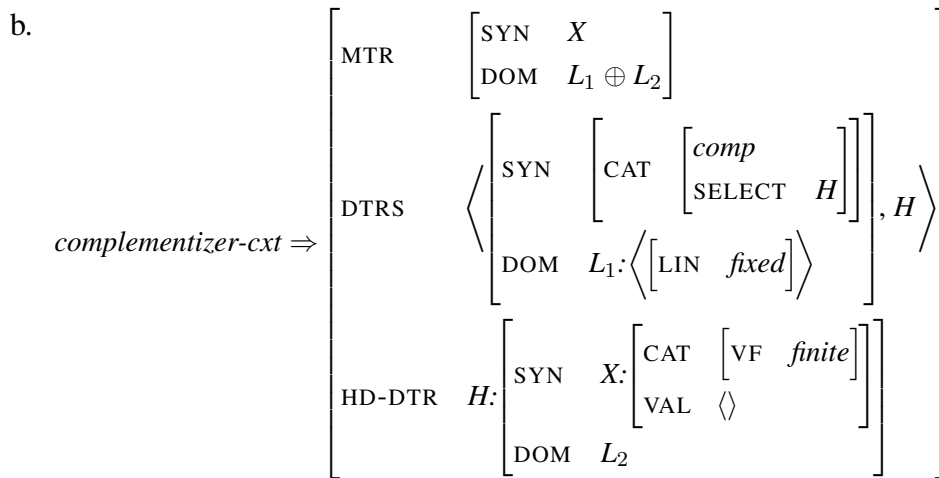

4.3 Language-specific clause licensing

The clausal constructions presented in the previous section license the characteristics of word order which all verb second languages share and extend upon. To illustrate the shared properties among such languages, I provide language-specific hierarchies of clausal constraints for German, Breton, and Kashmiri, which provide a representative sample of the possible constructions and word order combinations in V2 languages. At the core of all of these language-specific analyses are the common clausal constructions, which highlight their use as the fundamental mechanisms for word order determination and clause licensing in a variety of sentence types. Furthermore, I

will show how these constraints interact with other standard SBCG constructions to license a wide range of sentences.

The use of the generalized mechanisms to describe the clause structure in a particular language may be illustrated by a fuller hierarchy of PHRASAL CONSTRUCTIONS in Figure 4.3. The HEADED CONSTRUCTIONS were initially discussed in §3.3 and are extended here. A HEAD-COMPLEMENT CONSTRUCTION, like the SUBJECT-PREDICATE CONSTRUCTION in (100), allows a verbal head to combine with one or more of its arguments, thus removing that argument from its VALENCE list. This construction has two sub-types: the PREDICATIONAL CONSTRUCTION, which combines a verbal head with some of its arguments, but not all, and the SATURATIONAL CONSTRUCTION, which combines a verbal head with all of the remaining elements on its VALENCE list and licenses a saturated clause. Additionally, a HEAD-FUNCTOR CONSTRUCTION allows the combination of a modifier with the element that it modifies. For instance, this construction licenses the combination of a determiner and the noun phrase it selects for.

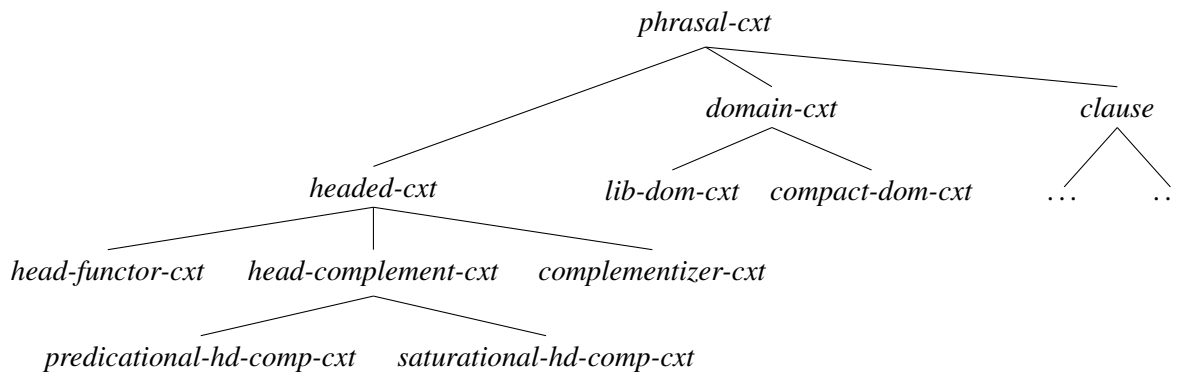

Figure 4.3: Partial hierarchy of phrasal constructs for V2 languages.

Given this complete hierarchy of PHRASAL CONSTRUCTIONS, constructs may now be fully licensed by a combination of HEADED, DOMAIN, LINEAR CLAUSE, and SENTENCE-MODE CLAUSE CONSTRUCTIONS, which will be shown individually for German, Breton, and Kashmiri, in the following sections.

4.3.1 German

Consider the clausal hierarchy for German in Figure 4.4, which utilizes the common clausal constraints from Figure 4.2.¹ The bottom row in this hierarchy represents a sampling of complete clause constructs, which are a combination of the *linear* and *sentence-mode* types.

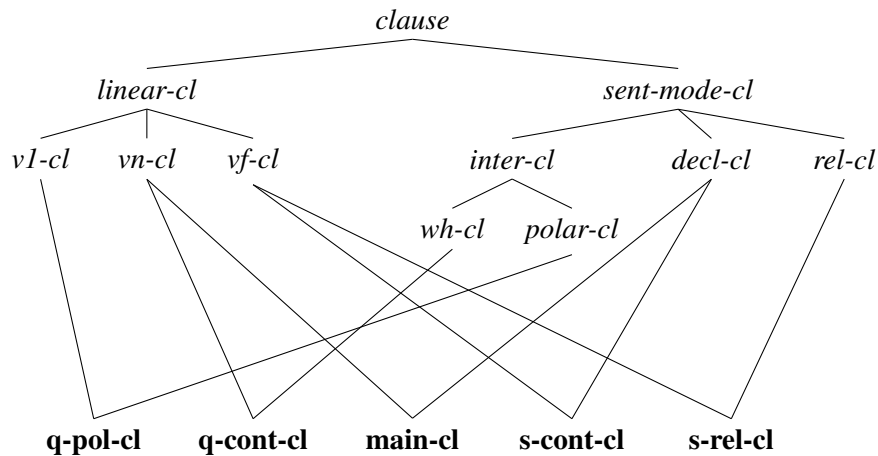

Figure 4.4: Partial hierarchy of clausal constructs for German.

4.3.1.1 Verb Second

Referencing the hierarchy in Figure 4.4, the sentence in (165a) shows the instantiation of a MAIN-CLAUSE CONSTRUCTION, that is, a clause which both satisfies the constraints of the VN and DECLARATIVE-CLAUSE CONSTRUCTIONS. The illustration of the domain structure in (165b) shows that the finite verb is *fixed* and that only one *flexible* domain appears before it.² In this example, information-structure-oriented LP rules, which are not formally defined in this analysis, have specified that the dative object must appear before the other *flexible* domains.

¹In all clausal hierarchies the following abbreviations are used to conserve space: s(ubordinate), cont(ent), rel(ative), q(uestion), pol(ar).

²Abbreviations will also be used in AVMs to conserve space: D(OM), L(IN), F(ORM), S(YN), C(AT), VF(ORM).

- (165) a. Dem Jungen **wollte** Peter das Buch schenken.
 the.DAT boy.DAT want.PST.3SG Peter the.ACC book give.INF
 ‘Peter wanted to give the book to the boy.’ *German* (Uszkoreit, 1987, 156)

b.
$$\left[\text{D} \left\langle \left[\begin{array}{l} \text{L } flexible \\ \text{F} \langle dem, Jungen \rangle \\ \text{S NP} [dat] \end{array} \right], \left[\begin{array}{l} \text{L } fixed \\ \text{F} \langle wollte \rangle \\ \text{S V} [fn] \end{array} \right], \left[\begin{array}{l} \text{L } flexible \\ \text{F} \langle Peter \rangle \\ \text{S NP} [nom] \end{array} \right], \left[\begin{array}{l} \text{L } flexible \\ \text{F} \langle das, Buch \rangle \\ \text{S NP} [acc] \end{array} \right], \left[\begin{array}{l} \text{L } flexible \\ \text{F} \langle schenken \rangle \\ \text{S V} [base] \end{array} \right] \right\rangle \right]$$

The constructions which license this verb second German sentence are provided in (166), which are derived from a combination of the constructs in Figures 4.3 and 4.4. That is, these constructions are created by the unification of a set of other constructions, a process formally known as multiple inheritance. In Figure 4.5, the construction which licenses a particular construct is printed to the left of its feature structure. These newly-defined constructions are German-specific and need not exist in other languages.

- (166) Some PHRASAL CONSTRUCTIONS for German

- a. *determiner-cxt* \Rightarrow *head-functor-cxt* \wedge *compacting-domain-cxt*
 b. *lib-pred-hd-comp-cxt* \Rightarrow *predicational-head-complement-cxt* \wedge *liberating-domain-cxt*
 c. *main-lib-sat-hd-comp-cl* \Rightarrow *saturational-head-comp-cxt* \wedge *declarative-cl* \wedge
liberating-domain-cxt \wedge *vn-cl*

The complete derivation of the V2 sentence in (165a) is illustrated in Figure 4.5. Here, the MAIN-LIB-SAT-HD-COMP-CLAUSE CONSTRUCTION licenses the saturation of the finite verb’s complement list while keeping all of the domain elements liberated and free to shuffle except for the finite verb itself, which is constructionally specified as *fixed* and relegated to the position after a single *flexible* domain, as according to the VN-CLAUSE CONSTRUCTION. A COMPLEX-PREDICATE CONSTRUCTION is used to create a verbal complex which combines all of the arguments from both verbs (cf. Hinrichs and Nakazawa, 1998, *inter alia*).

The VN-CLAUSE CONSTRUCTION constrains all of the domain elements to be *flexible* except for the finite verb domain. So, the LINEARIZATION value of all the domain elements are resolved to a maximal value by this construction: either *fixed* or *flexible*. Language-dependent LP rules then

4.3.1.2 Partial Verb Phrase

Similarly, it is possible to describe the realization of a partial verb phrase in the first position via compacting constructions. Consider the sentence in (167) with the partial verb phrase *das Buch schenken* ‘the book give’ in the first position. This is only possible because the whole phrase is contained within a single domain. A construct such as this is licensed by the construction in (168) which combines the constraints of the PREDICATIONAL and COMPACTING DOMAIN CONSTRUCTIONS. Thus, this sentence with a partial verb phrase may be licensed by the series of constructions illustrated in Figure 4.6. The partial verb phrase appears in the first position because of an LP rule, such as the one in (159) which forces a *flexible* non-focused element before all other *flexible* focused ones.

- (167) a. Das Buch schenken **wollte** Peter dem Jungen.
 the.ACC book give.INF want.PST.3SG Peter the.DAT boy
 ‘Peter wanted to give the book to the boy.’ *German* (Uszkoreit, 1987, 156)

$$b. \left[\begin{array}{c} \left[\begin{array}{c} \text{L } flexible \\ \text{F } \langle \textit{das, Buch, schenken} \rangle \\ \text{S VP } [base] \end{array} \right], \left[\begin{array}{c} \text{fixed} \\ \text{F } \langle \textit{wollte} \rangle \\ \text{S V } [fin] \end{array} \right], \left[\begin{array}{c} \text{L } flexible \\ \text{F } \langle \textit{Peter} \rangle \\ \text{S NP } [nom] \end{array} \right], \left[\begin{array}{c} \text{L } flexible \\ \text{F } \langle \textit{dem, Jungen} \rangle \\ \text{S NP } [dat] \end{array} \right] \end{array} \right]$$

- (168) *compact-pred-hd-comp-cxt* \Rightarrow *pred-hd-comp-cxt* \wedge *compact-dom-cxt*

4.3.1.3 Verb Third

Similarly, the V3 sentence in (69) can be licensed by the same VN-CLAUSE CONSTRUCTION with further language-specific constraints, such as the DISCOURSE-PROMINENCE CONSTRUCTIONS in (169). These constructions utilize partial compaction, as mentioned in §4.2.2, which allow the first two elements before the finite verb to form a single domain element despite not forming a phrase structure constituent.

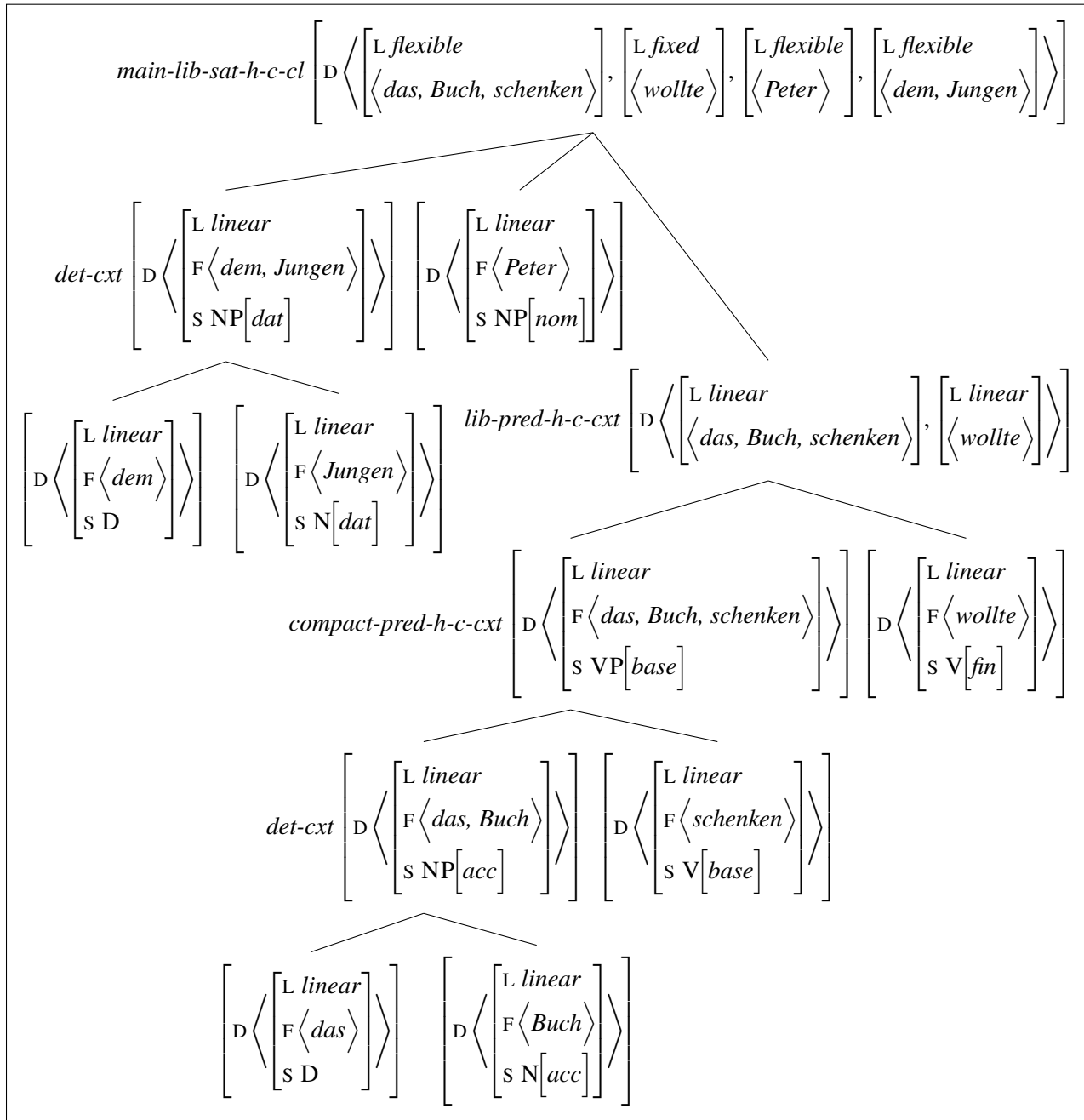

Figure 4.6: A construct showing compaction of a partial verb phrase in German.

(169) DISCOURSE PROMINENCE CONSTRUCTIONS for German

$$a. \text{doms}_\circ \left(\left\langle \left[\text{DOM } L_1 \right], \dots, \left[\text{DOM } L_n \right] \right\rangle \right) \equiv L_1 \circ \dots \circ L_n$$

$$b. \text{prom-part-compact-dom-cxt} \Rightarrow \left[\begin{array}{l} \text{MTR} \quad \left[\text{DOM} \quad \left\langle \left[\begin{array}{l} \text{PROM} + \\ \text{DOM} \quad \text{doms}_\circ(L_1) \end{array} \right] \right\rangle \circ \text{doms}_\circ(L_2) \right] \\ \text{DTRS} \quad L_1:\text{list} \left(\left[\text{PROM} + \right] \right) \circ L_2:\text{list} \end{array} \right]$$

$$c. \text{prom-main-cl} \Rightarrow \text{main-lib-sat-hd-comp-cl} \wedge \text{prom-part-compact-dom-cxt}$$

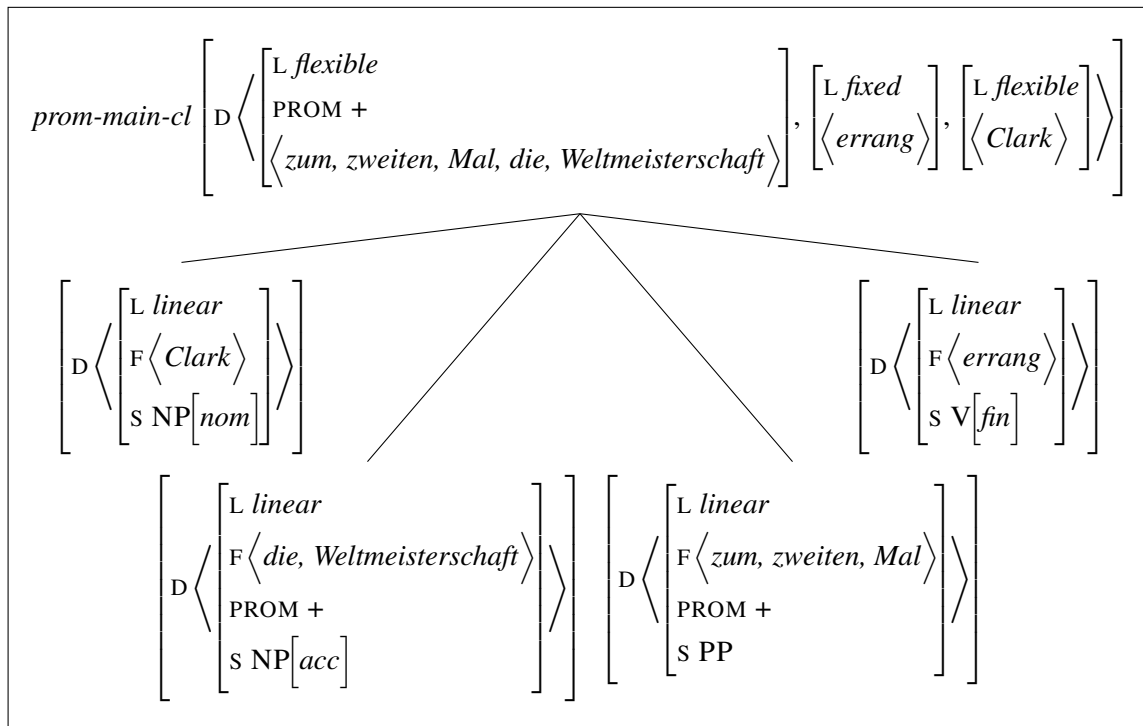

Figure 4.7: Clause structure for German V3 sentence.

First, the doms_\circ function in (169a) takes a list of elements and extracts their DOM lists to create a new list which consists of all of the extracted DOM lists. Next, the PROMINENCE-PARTIAL-COMPACTION-DOMAIN CONSTRUCTION shown in (169b) appeals to a common discourse-oriented feature. Here this discourse feature is represented by a binary PROM(INENCE) attribute. This construction licenses all of the domains of the discourse prominent elements to be compacted together as a single domain while all other elements remain liberated. Linear precedence rules subsequently

cause the single prominent domain element to appear in the clause initial position. Figure 4.7 illustrates this clause structure for the V3 sentence in (69). This construction and new feature are only used for illustrative purposes and do not necessarily reflect a pragmatic analysis, instead they only show how such an analysis is compatible with the other word order constraints proposed in this paper.

4.3.1.4 Verb Final

A verb final clause, as in the case of German subordinate clauses, may be licensed by the construction in (170). This clause construction requires that a content subordinate clause realizes the finite verb in the final domain and that the first domain is occupied by the complementizer. The domain configuration of the sentence in (171) is thus licensed by this COMPLEMENTIZER-SUBORDINATE-CONTENT-CLAUSE CONSTRUCTION.

(170) *complementizer-subord-cont-cl* \Rightarrow *complementizer-cxt* \wedge *s-cont-cl*

(171) a. Paul weiß, [dass Peter nach Hause **kommt**].
 Paul know.3SG that Peter to home come.3SG
 ‘Paul knows that Peter is coming home.’ *German* (Uszkoreit, 1987, 13)

b.
$$\left[\text{DOM} \left\langle \left[\begin{array}{l} \text{LIN } \textit{fixed} \\ \text{FORM} \langle \textit{dass} \rangle \\ \text{SYN COMP} \end{array} \right], \left[\begin{array}{l} \text{LIN } \textit{flexible} \\ \text{FORM} \langle \textit{Peter} \rangle \\ \text{SYN NP}[\textit{nom}] \end{array} \right], \left[\begin{array}{l} \text{LIN } \textit{flexible} \\ \text{FORM} \langle \textit{nach, Hause} \rangle \\ \text{SYN PP} \end{array} \right], \left[\begin{array}{l} \text{LIN } \textit{fixed} \\ \text{FORM} \langle \textit{kommt} \rangle \\ \text{SYN VP}[\textit{fin}] \end{array} \right] \right\rangle \right]$$

4.3.1.5 Topicalization

Although a FILLER-HEAD CONSTRUCTION is not used to realize the first element of a basic V2 clause, it does allow the non-local extraction of an embedded element and appropriately interacts with the VN-CLAUSE CONSTRUCTION to license a complete sentence. For instance, consider (172) with an element extracted out of the subordinate clause into the first position of the matrix clause. Using the TOPICALIZATION CONSTRUCTION in (173) the clause structure for this complex sentence is illustrated in Figure 4.8.

- (172) [Um zwei Millionen Mark]_i **versucht** er [eine Versicherung _{-i} zu betrügen]
 of two million Mark try.1SG.PRS he a insurance to defraud.INF
 ‘Of two million Marks, he is trying to defraud an insurance company.’ *German* (adapted from Müller, 2005a)

- (173) TOPICALIZATION CONSTRUCTION for German

top-main-cl ⇒ *main-lib-sat-hd-comp-cl* ∧ *filler-head-cxt*

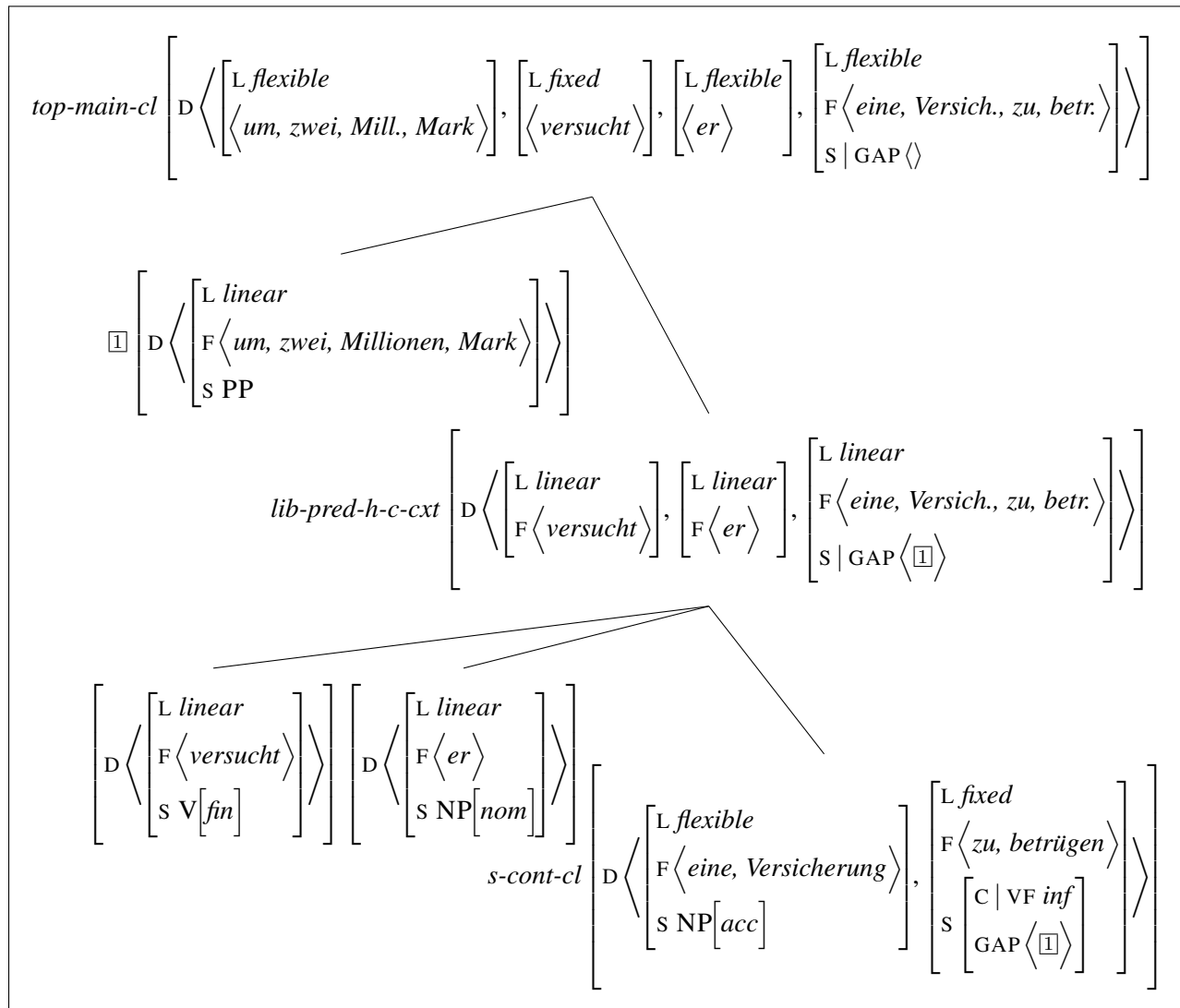

Figure 4.8: Clause structure for German sentence with topicalized element.

4.3.2 Breton

Breton also has its own language-specific hierarchy of clausal constraints and which, like German and all V2 languages, extend the common clausal constructions in Figure 4.9. As there are word order differences between affirmative and negative main clauses in Breton, namely, affirmative are V2 while negative verb initial, it is necessary to split the *declarative construct* into an *affirmative* and *negative* variant for Breton only.

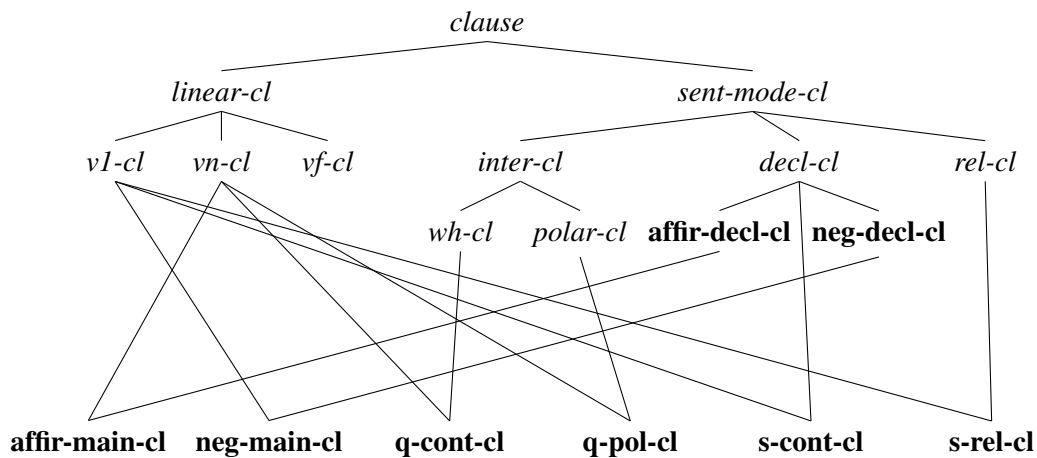

Figure 4.9: Partial hierarchy of clausal constructs for Breton.

4.3.2.1 Verb Second

An *affirmative-main-clause* is exemplified by the sentence in (174). This example once again illustrates the importance of compaction in the stipulation of word order. In Breton, the verbs, both finite and non-finite, appear together in the second position of a main clause, except when a non-finite verb has been moved to the first position in an *ober* construction (cf. §2.3). Thus, the verbal elements in (174) are in a single domain.

- (174) a. E voued **en deus debret** Yann er wetur
 his food 3SG.M have.PRS.3SG eat.PST.PTCP Yann in.the car
 ‘Yann has eaten his food in the car.’ *Breton* (Press, 1986, 200)

$$b. \left[D \left\langle \left[\begin{array}{l} L \text{ flexible} \\ F \langle e, \text{voued} \rangle \\ S \text{ NP}[\text{acc}] \end{array} \right], \left[\begin{array}{l} L \text{ fixed} \\ F \langle en, \text{deus, debret} \rangle \\ S \text{ VP}[\text{fin}] \end{array} \right], \left[\begin{array}{l} L \text{ flexible} \\ F \langle Yann \rangle \\ S \text{ NP}[\text{nom}] \end{array} \right], \left[\begin{array}{l} L \text{ flexible} \\ F \langle er, \text{wetur} \rangle \\ S \text{ PP} \end{array} \right] \right\rangle \right]$$

Conceptually this grouping of verbs resembles complex predicates in Romance languages, which are ‘a series of verbs or, more generally, predicates, [that] function like a single verb with respect to certain syntactic and semantic properties’ (Abeillé and Godard, 2010, 107). The licensing of this sentence with a single verbal domain is depicted by the construct in Figure 4.10. The same LIBERATING and COMPACTING-PREDICATION-HEAD-COMPLEMENT CONSTRUCTIONS as defined for German in (166b) and (168), as well as an additional one in (175) licenses this Breton construct.

(175) *aff-main-lib-sat-h-c-cl* \Rightarrow *saturational-head-complement-cxt* \wedge *liberating-domain-cxt* \wedge

affirmative-main-cl

4.3.2.2 Verb Initial

Unlike German, Breton does not have a complementizer for a subordinate complement clause except in the cases of *ma* and *hag-en* as described in §2.2.1. Thus, an additional construction for these complementizer-less clauses, such as in (170) for a German subordinate clause, is not necessary for Breton. Rather, a subordinate clause in Breton is licensed alone by the language-specific SUBORDINATE-CONTENT-CLAUSE CONSTRUCTION in Figure 4.9. Example (176) illustrates this word order domain configuration.

(176) a. Gwelout a reas Lenaig [e save an dour].
 see.INF PRT do.PST.3SG Lenaig PRT rise.PST the water
 ‘Lenaig saw the water was rising.’ *Breton* (Stephens, 2002, 399)

$$b. \left[\text{DOM} \left\langle \left[\begin{array}{l} \text{LIN fixed} \\ \text{FORM} \langle e, \text{save} \rangle \\ \text{SYN VP}[\text{fin}] \end{array} \right], \left[\begin{array}{l} \text{LIN flexible} \\ \text{FORM} \langle an, \text{dour} \rangle \\ \text{SYN NP}[\text{nom}] \end{array} \right] \right\rangle \right]$$

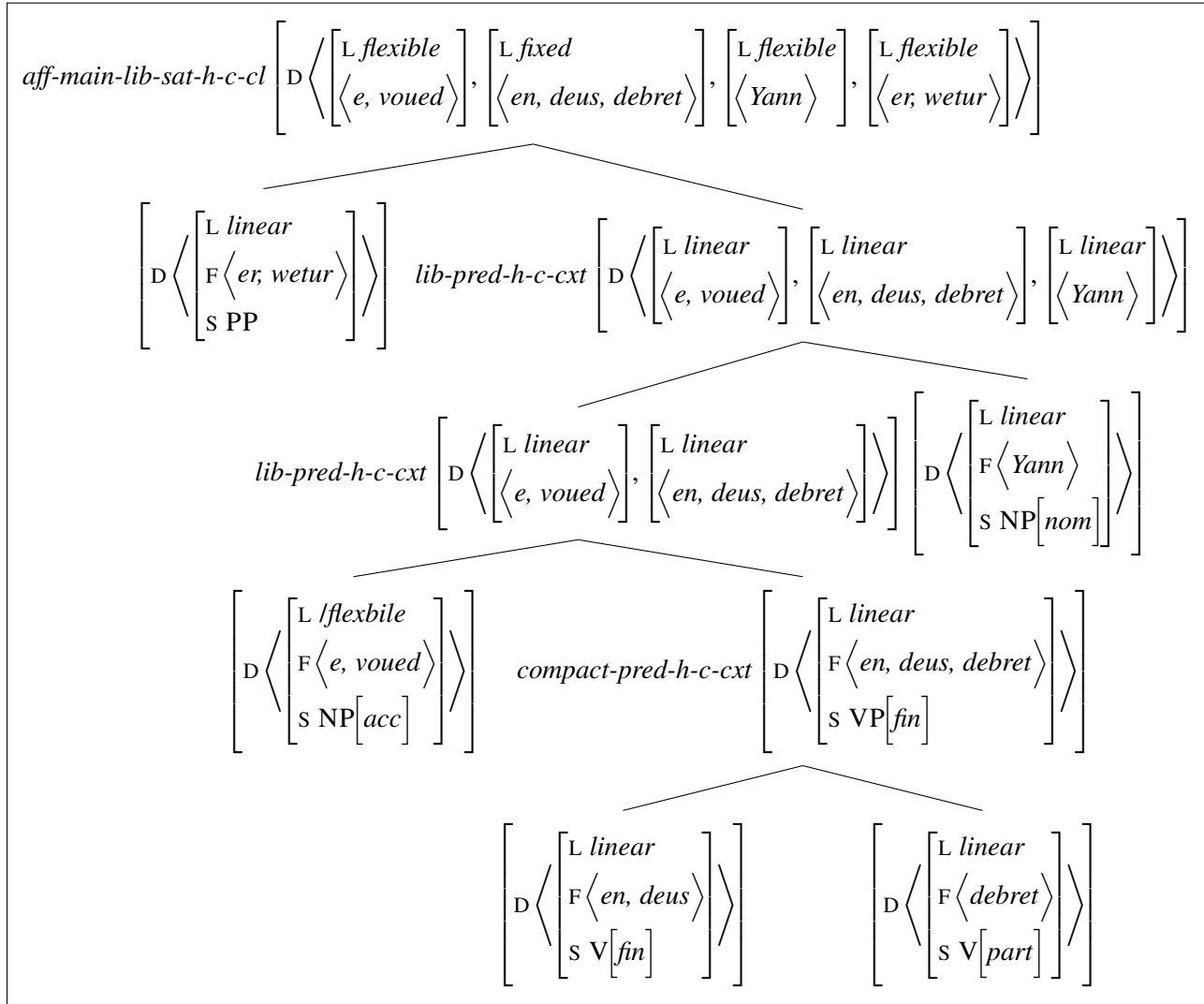

Figure 4.10: A construct showing compaction of verbs in Breton.

4.3.3 Kashmiri

Finally, Kashmiri also attests a language-specific combination of the common clausal constructions to license its clausal structures as shown in Figure 4.11. Kashmiri is particularly interesting because it illustrates the manner in which an obligatory verb third clause is licensed, namely, by the versatile VN-CLAUSE CONSTRUCTION. Until now, this construction has only been used to license clauses with a single domain before the finite verb. But because it allows any number of *fixed* domains before the finite verb, verb third clauses with two initial non-finite verb domains are also possible.

To allow such a word order, it is necessary to provide further constraints on the Kashmiri V3

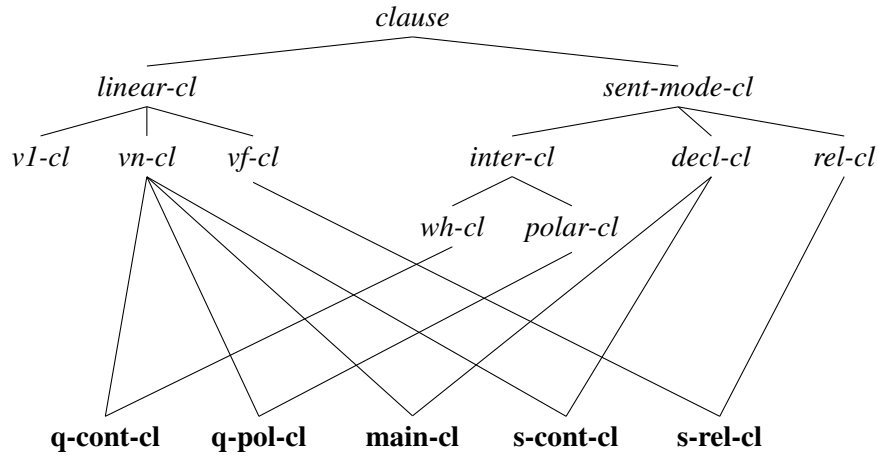

Figure 4.11: Partial hierarchy of clausal constructs for Kashmiri

QUESTION-CONTENT CLAUSE CONSTRUCTION, provided in (177). This construction stipulates that in addition to the constraints of the VN and WH-CLAUSE CONSTRUCTIONS, the domain list must begin with one *flexible* domain which is then followed by a *fixed* question word. This further constraint is compatible with the VN-CLAUSE CONSTRUCTION which simply states that only one *flexible* domain may appear before the finite verb.

(177) CONTENT QUESTION CONSTRUCTION for Kashmiri

$$cont-question-cl \Rightarrow vn-cl \wedge wh-cl \wedge \left[\text{DOM} \left\langle \left[\text{LIN} \quad flexible \right], \left[\text{LIN} \quad fixed \right], \left[\text{SYN} \quad \text{WH} \right], \dots \right\rangle \right]$$

To illustrate a Kashmiri content question, consider the sentence in (178), whose domain order is licensed by the Kashmiri-specific QUESTION-CONTENT CLAUSE CONSTRUCTION. The clause begins with one *flexible* domain which is then followed by a *fixed* question word domain. This simultaneously satisfies the VN-CLAUSE CONSTRUCTION which specifies that there is a *fixed* finite verb domain before which only one *flexible* domain may occur. Because all of these constraints are met, the content question is formally licensed.

- (178) a. raath kyaa **dyut-na-y** rameshan tse
 yesterday what.NOM give.PST.M.SG-3SG.ERG-2SG.DAT Ramesh.ERG you.DAT
 ‘As for yesterday, what is it that Ramesh gave you?’ [kas] (Bhatt, 1999, 107)

b.
$$\left[\begin{array}{c} \left[\begin{array}{c} \text{L } \langle \text{flexible} \rangle \\ \text{F } \langle \text{raath} \rangle \\ \text{S ADV} \end{array} \right], \left[\begin{array}{c} \text{L } \langle \text{fixed} \rangle \\ \text{F } \langle \text{kyaa} \rangle \\ \text{S WH} \end{array} \right], \left[\begin{array}{c} \text{L } \langle \text{fixed} \rangle \\ \text{F } \langle \text{dyutnay} \rangle \\ \text{S V} \left[\begin{array}{c} \text{fn} \end{array} \right] \end{array} \right], \left[\begin{array}{c} \text{L } \langle \text{flexible} \rangle \\ \text{F } \langle \text{rameshan} \rangle \\ \text{S NP} \end{array} \right], \left[\begin{array}{c} \text{L } \langle \text{flexible} \rangle \\ \text{F } \langle \text{tse} \rangle \\ \text{S NP} \end{array} \right] \end{array} \right]$$

4.4 Summary

In this chapter, I formalize a construction and linearization-based approach to word order inspired by Kathol (2000). I identify a general set of cross-linguistic construction types that characterize word order patterns:

§4.1 Traditional topological fields, represented as domain types, are sufficient for German, but they are too language-specific to be cross-linguistically valid: There is not a single set of topological fields that correctly describes the word orders in all V2 languages.

§4.2 A small set of generalized mechanisms account for all the needed syntactic properties of flexible word order. These mechanisms include two-typed domain elements, domain compaction, and cross-linguistic word order constructions. Unlike previous analyses, these mechanisms do not include topological fields or a long-distance dependency relationship to account for V2 word order in local contexts, which I have argued against. All V2 languages share core linearization constructions.

§4.3 By example of German, Breton, and Kashmiri, I have shown how the common clausal constructions of V2 languages license a sampling of clause types. The mechanisms accounting for this sampling can easily be extended to other clause types of V2 languages.

So, by examining the mutually-shared characteristics of V2 languages it is possible to define the common mechanisms which accurately describe their word orders, namely:

- A shared set of LINEAR, SENTENCE-MODE, and DOMAIN CONSTRUCTIONS

- *flexible* and *fixed* domain elements
- Language-specific constructions which specify *fixed* domain elements
- Domain compaction
- Linear precedence rules which only affect *flexible* domain element

The analysis in this chapter is heavily domain-based, which means that the combinatorial properties of constructions do not necessarily affect word order. So, while I argue that long-distance dependencies are not necessary to account for V2 word order in local contexts, a domain analysis does not preclude it. Thus, using this analysis as proof that simple constructions appropriately license flexible word order across languages in a surface-oriented manner, I present a more complete analysis of V2 word order in the next chapter which does not utilize domains. Rather, the principles of fixed and flexible elements are directly encoded into flatter constructions which handle word order as well as argument saturation.

Chapter 5

Flat Constructions

The domain-based analysis in Chapter 4 demonstrates that flexible word order can be licensed in a surface-oriented manner. However, this analysis makes few claims about the combinatorial structure of utterances and instead relies on *word order domains* to liberate and stipulate the linear realization of a clause. In this chapter, I explore the use of constructions to directly license both the combinatorial and linear properties of utterances in flexible word order languages. Constructional approaches place “core” and “peripheral” grammatical structures at the extremes of a spectrum of syntactic phenomena and thus do not view them as distinct operations to be analyzed separately (cf. Fillmore et al., 1988; Kay and Fillmore, 1999). As such, both lexical and phrasal constructions provide form-meaning pairings so that syntactic configurations may have associated meaning just as easily as individual words. Sign-Based Construction Grammar (SBCG) combines this idea of word-independent, sentence-level constructions with the mathematically-grounded formalism Head-Driven Phrase Structure Grammar (HPSG) (Pollard and Sag, 1994; Sag et al., 2003), which offers the ability to precisely formalize and test construction-oriented analyses. Thus, it is the SBCG formalism which will be used to describe the analysis here, as in the previous chapter.

German is used as the test bed for a flat construction-based theory of word order because of its unique word order properties, namely verb second (V2), as well as highly flexible word order, which provide a wide range of phenomena to thoroughly test such a theory. Unlike the previous chapter, I will not provide any cross-linguistic generalizations; however a flat analysis is certainly possible for other languages like Breton and Kashmiri. In fact, the generalized constructions discussed in the previous chapter have exact counterparts in the flat analysis described here. But by

concentrating solely on German, it allows a much more detailed and deeper analysis to ensure the accuracy and completeness of a flat construction-based theory.

This construction-based analysis does not utilize word order domains but does use the shuffle operator ‘ \circ ’ to allow phrases to be ordered in multiple ways, as discussed in §3.5. And because I do not model V2 word order with extraction, these constructions describe much flatter structures than in conventional approaches. The discussion in Chapter 3 supports a flatter analysis and asserts that such traditionally complex and deeply-embedded structures, which make heavy use of extraction, are not appropriate for flexible word order languages, and it is here that I show with a formalized analysis that these complex structures are not needed.

I begin this chapter by first providing evidence supporting flatter analyses of syntactic structure in §5.1, which builds upon the evidence in previous chapters. Subsequently, I describe how the flat constructions introduced here can interact to license both argument structure as well as permissible word orders beginning in §5.2. It is then shown how these interacting flat constructions can be used to license the full spectrum of German clauses and their various components including complex predicates, partial verb phrases, adjuncts, and verb third word order in §5.3 – §5.7. Here it is my goal to contribute to the evidence supporting construction-based and surface-oriented analyses with flatter structures for flexible word order by providing a formal examination of German clause structure.

5.1 Evidence for Flatter Structure

Principles and Parameters Theory (PPT) and the Minimalist Program seek to determine the set of linguistic universal parameters that are innate to all humans. They posit that these parameters allow the acquisition of grammar given a poverty of stimulus, which they view as an otherwise impossible task. That is, humans are able to learn seemingly complex grammars because of innate parameters with little needed evidence. As a consequence, these theories involve complex syntactic structures and abstract machinery, which are comparatively more complex than those of theories that are not so strongly committed to the same views. While some argue that the structures in these theories are minimally complex because they solely consist of binary branching trees due

to a basic Merge operation, the large array of principles restricting the possible types of trees and their configurations increases the complexity and opaqueness of the resulting structures (cf. §3.1).

Culicover (1999) is critical of the motivation for a set of minimal parameters, particularly because syntactic phenomena are divided into those which belong to either core or peripheral, that is, idiosyncratic, phenomena. It is only the core grammar that the Chomskyan theories primarily seek to describe by means of stipulating as few parameters as possible, which necessitates the postulation of deep and complex syntactic structures. In this way, a single parameter can determine the nature of a single deep syntactic structure which then has consequences throughout the entire grammar. This kind of task becomes increasingly difficult if one were to include non-core phenomena. But by only describing the core grammar, the theory is, in fact, not describing the complete grammar of a language which includes these peripheral structures.

Furthermore, Culicover (1999, 15) asserts that this approach to syntax, which only seeks to describe what is considered core grammar, is flawed. Humans are equally able to acquire and use both core and peripheral syntactic structures, so there must be cognitive mechanisms to equally acquire both types of phenomena. If the goal is to no longer only describe core grammar, then it appears that a small set of parameters and the complex structure that it requires, is not desirable. Instead, syntactic structure, including all types from the core to periphery, should only be as complex as the cognitive mechanisms, which may feasibly generalize them from overt linguistic evidence. Supporting this view, Newmeyer (2004) argues that the number of needed parameters to account for all typological variation is prohibitively large and could not possibly be part of some innate grammar. Instead it must be possible to acquire language-dependent parameters and patterns.

Culicover (1999, 12) notes that Chomsky (1965, 196) originally argued against postulating complex syntactic representations without direct empirical evidence. Chomsky wrote:

It has sometimes been claimed that the traditional coordinate structures are necessarily right-recursive (Yngve, 1960) or left-recursive (Harman, 1963, p.613, rule 3i). These conclusions seem to me equally unacceptable. Thus to assume (with Harman) that the phrase “a tall, young, handsome, intelligent man” has the structure [[[[tall young] handsome] intelligent] man] seems to me no more justifiable than to assume that it has

the structure [tall [young [handsome [intelligent man]]]]. In fact, there is no grammatical motivation for any internal structure, . . .

Chomsky even insisted that “[t]he burden of proof rests on one who claims additional structure beyond this” (Chomsky, 1965, 197).

The theory of word order that follows is very much in this early Chomskyan spirit: I assume that structures are shallow unless there is strong empirical evidence that they are not. That is, I only posit structure which is reasonably supported by empirical evidence from the full spectrum of attested constructions, i.e from core to peripheral phenomena, and adopt the simplest and most general analysis which a language learner may plausibly be able to determine from overt evidence. This often results in constructions that are flatter than standardly assumed.

5.1.1 Implausible Binary Branching Structures

Some syntactic theories like Government and Binding or certain analyses in HPSG posit deeply branching structures of binary relationships. This type of structure is deemed necessary in order to maintain uniform underlying structure for all types of syntactic phenomena. However, many aspects of this deeply branching structure are not empirically grounded and are, in fact, erroneous, as argued by Culicover and Jackendoff (2005, Ch. 4).

Culicover and Jackendoff show that binary branching structures are unwarranted and that simpler, more minimal structures which describe correspondences between basic syntactic patterns and their meanings are better supported by both syntactic and psycholinguistic evidence. They seek an account of syntactic structure where there is not “so little structure that [they] have to find another account of such facts” but where there is also not “too much structure, i.e. structure that plays no role in determining either word order or interpretations. Such structure, [they] argue, is an artifact of the theoretical apparatus adopted within the syntactic theory” (Culicover and Jackendoff, 2005, 108). I adopt their same view on syntax.

In this section, I will explore their arguments because they offer persuasive evidence against binary branching structures which consequently show that the flatter constructions I posit for German word order are more desirable. Furthermore, I consider evidence from anaphora and French

complex predicates which are also more straightforwardly analyzed as flat structures.

5.1.1.1 Learnability

While it may seem that the prescription of binary structure may increase the learnability of syntactic phenomena, Culicover and Jackendoff show that this need not be the case. They consider the arguments of Haegeman (1992) who promotes the necessity of uniformly binary branching structures. For instance, the structure [A B C], she claims, is easier to learn if the constituent is always parsed with the similar binary branching structure [A [B C]]. However, Culicover (1997) asserts that the choice of binary branching structure does not necessarily make the structure more learnable. It is, in fact, just as easy to learn the structure [A B C] whole as it is to learn the nested structure [A [B C]]. It is only when both possibilities are available that learnability issues arise because a speaker must learn then to differentiate the two structures without any overt evidence.

Furthermore, Culicover and Jackendoff (2005) argue that human cognition does not appear to operate solely on binary operations, which is what uniform binary branching in syntax seems to suggest. For instance, consider how the visual array of X's and O's in Figure 5.1 should be cognitively represented. There is no evidence suggesting that this structure is built by any binary operation. That is, Culicover and Jackendoff assert that a single set of X's does not have the structure [x[x[x[x[x]]]]]. It would become even more complicated to represent this two-dimensional structure with binary relations particularly because it is unclear if the rows or if the columns relate to each other. Thus, it is most plausible that the X and O structures are simply stored as flat units in a manner which stipulates that a certain number of elements relate to the others in a particular manner. This type of argument can also be used with other cognitive process such as the representation of musical structure.

```

XXXXX  OOOOO  XXXXX
OOOOO  XXXXX  OOOOO
XXXXX  OOOOO  XXXXX

```

Figure 5.1: A visual array with recursion (Culicover and Jackendoff, 2005, 114).

So, following this argument of Culicover and Jackendoff, linguistic structure is also most plausibly combined in flatter relationships which could be defined as constructions. There is no ne-

cessity of binary branching structures to increase the learnability of language or make it easier for cognitive processing.

5.1.1.2 Right Branching

Theories that posit binary branching structures, like Government and Binding, tend to involve a uniform branching direction. This seemingly provides an elegant way to account for certain phenomena. For instance, advocates of right-branching structure argue that it lends itself well for simplifying the description of binding phenomena by utilizing the c-command relationship (Culicover and Jackendoff, 2005, 117). Basically, elements in a right-branching structure will always c-command the elements to the right, but not vice versa. So, if it is stated that an antecedent must c-command its corresponding anaphor, then that anaphor will always be to the right of the antecedent. The analysis of the binding phenomenon can then be simplified by removing the need to stipulate their linear order. This can be seen by considering the sentences in (179). Given a binary right branching structure, *John* c-commands *himself* in the first sentence, thus making it acceptable. However, in the second sentence, *himself* c-commands *John*. Because the antecedent does not c-command its anaphor, this sentence is correctly deemed ungrammatical.

- (179) a. Mary showed John_i himself_i.
 b. *Mary showed himself_i John_i. (Culicover and Jackendoff, 2005, 118)

However, Culicover and Jackendoff (2005) argue that the c-command relationship does not validate binding in all types of clauses. For instance, the binding of antecedents in sentences with ditransitive verbs are not correctly handled by c-command, as observed in the sentences in (180).

- (180) a. *John showed herself_i as a young girl to Mary_i.
 b. John showed to Mary_i herself_i as a young girl. (Culicover and Jackendoff, 2005, 119)

The first sentence exhibits the canonical order of arguments, which is correctly predicted to be ungrammatical due to the fact that the antecedent does not c-commanding the anaphor. However, the second sentence is grammatical despite no c-command relationship. That is, the antecedent *Mary* appears in an adjunct, which due to heavy shift appears before *herself*. Because *Mary* is

the object of a preposition, it cannot c-command *herself*. Yet, a binding relationship does exist between these two elements. Instead, Culicover and Jackendoff (2005, 119) conclude that it is only important that both the antecedent and anaphor are in the same clause and *Mary* is to the left of *herself*. So, linear order is important and not the type of branching structure.

Furthermore, these observations hold true for even more complex cases such as quantifier binding in (181) where the antecedent is the object of a preposition and binds with a pronoun in arguments or adjuncts to the right.

- (181) a. Mary talked to [every/no policeman on the force]_{*i*} about his_{*i*} political attitudes.
 b. Mary talked to [every/no policeman on the force]_{*i*} in order to convince him_{*i*} to take the captain's exam. (Culicover and Jackendoff, 2005, 122–123)

Modifications must be made to the typical type of c-command relationship in order to account for these bindings. But these modifications are not necessary because the most obvious and observable relationship is linear order: The quantifier appears to the left of the bound pronoun.

Thus, Culicover and Jackendoff conclude that c-command and the right-branching structure it requires do not provide an inadequate analysis of binding. The simplest explanation of the empirical evidence, they claim, is linear order (Culicover and Jackendoff, 2005, 130–131).

5.1.1.3 Left Branching

Similarly, Culicover and Jackendoff (2005, 131) also conclude that there is “inconclusive” evidence for left-branching structures. The classic motivation for left-branching structures are *do so* constructions such as those in (182): A left-branching VP allows all the antecedents of the *do so* anaphor to form appropriate constituents. That is, the anaphors *cook the potatoes*, *cook the potatoes for fifteen minutes*, and so forth, each form a constituent in a left-branching structure thus enabling them to be replaced by an anaphor.

- (182) Mary will cook the potatoes for fifteen minutes in the morning, and Susan . . .
- a. will do so for twenty minutes in the evening. [*do so* = cook the potatoes]
 - b. will do so in the evening. [*do so* = cook the potatoes for fifteen minutes]
 - c. will do so too. [*do so* = cook the potatoes for fifteen minutes in the morning] (Culicover and Jackendoff, 2005, 114)

However, it must not always be the case that the antecedent of *do so* is a continuous constituent. The sentence in (183b) shows an example of discontinuous elements which form the antecedent of the *do so* anaphor. Because this anaphor does not consist of a single constituent, a left-branching structure does not easily account for its replacement without some complex raising operations.

- (183) Robin slept for twelve hours in the bunkbed, and Leslie . . .
- a. did so on the futon. [*do so* = sleep for twelve hours]
 - b. did so for eight hours [*do so* = sleep . . . on the bunkbed] (Culicover and Jackendoff, 2005, 125)

Additionally, the *do so* phenomenon provides some insight into the structure of VPs. Under a left-branching analysis, the descriptive predicates in (184) are external to the constituent formed by the verb and its argument. This constituency easily accounts for the *do so* anaphor in (184a). However, in (185a) *eat vegetables* does not form a constituent which can be replaced by a *do so* anaphor. Thus, forcing a left-branching structure on this sentence would produce incorrect predictions.

- (184) a. Mary ate her vegetables nude, but Groucho did so in his pajamas.
 b. Mary_i [[eat vegetables_j] nude_i]
- (185) a. *Mary eats her vegetables raw, and Bill does so cooked.
 b. Mary_i [eat vegetables_j raw_j] (Culicover and Jackendoff, 2005, 128–129)

Just as the *do so* anaphor can refer to discontinuous elements in some verbal phrase, the *one* anaphor can also refer to discontinuous nominal elements and their modifiers. First, consider

the sentences in (186) which support a left binary branching structure. In each instance, the *one* anaphor may refer to a single node of a left branching tree.

- (186) I put that silly picture of Robin from Mary that was on the table next to ...
- a. this artful one of Susan from Gretel that was on the shelf. [*one* = picture]
 - b. this one of Susan from Gretel that was on the shelf. [*one* = (silly) picture]
 - c. this one from Gretel that was on the shelf. [*one* = (silly) picture (of Susan)]
 - d. this one that was on the shelf. [*one* = (silly) picture (of Susan) (from Gretel)]
 - e. this one. [*one* = (silly) picture (of Robin) (from Mary) (that was on the table)] (Culicover and Jackendoff, 2005, 136)

There are, however, antecedents of *one* which do not correspond to any single constituent as illustrated in (187). So, binary branching structure does not provide a complete description of the phenomenon. Culicover and Jackendoff (2005, 138) conclude that neither surface order nor any type of constituency are important for the *one* anaphor. Instead, *one* simply refers to some overall noun phrase that does not include any contrasted material. That is, this anaphor's antecedent is constrained by discourse and semantics. The head noun and its modifiers must only be syntactic sisters of each other.

- (187) ... that silly picture of Robin from Mary that is on the table, and ...
- a. this artful one from Susan. [*one* = picture (of Robin) (that is on the table)]
 - b. this one from Susan. [*one* = (silly) picture (of Robin) (that is on the table)]

Culicover and Jackendoff conclude that there is no strong evidence for left-branching structures. In general, complex binary branching structures and abstract concepts like c-command do not necessarily explain all phenomena without the addition of abstract mechanisms like raising. That is, in order to maintain binary structures, one must rely on complex stipulations which are not easily observed and are hard to test.

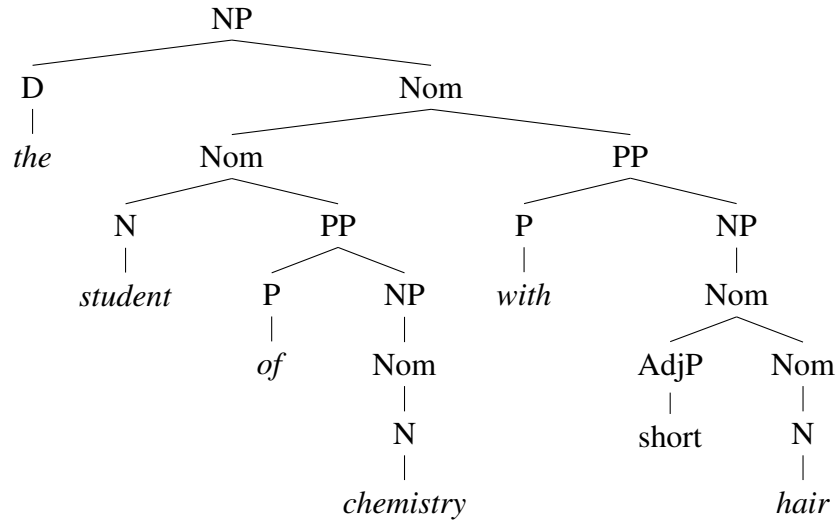

Figure 5.2: Putative structure of NP with nominal complement and modifier.

5.1.1.4 Nominal Complements and Modifiers

Baker (1978) argues that the anaphor *one* illustrates the structural difference between modifiers and complements. This is illustrated by (188) and (189), in which *one* has *student* as its antecedent. Baker claims that (188) is ungrammatical and that the noun phrase *the one of physics* must consequently have a different structure than the phrase *the one with long hair* in (189).

(188) The student of chemistry was more thoroughly prepared than the one of physics. (Baker, 1978, 415)

(189) The student with short hair is taller than the one with long hair. (Baker, 1978, 419)

In recent experiments, Lidz et al. (2003) show that 18-month old children already compute the various possible interpretations for one-anaphora.¹ The fact that children this young can apparently learn this suggests that X' theory is innate. However, Payne et al. (2013) show that there is no empirical basis for such a claim.

A corpus investigation conducted by Payne and Berlage (2009) shows that *of*-PPs and *one* anaphors actually do often co-occur. The sentences in (190)–(193) show some of their data with the semantic interpretation in curly braces where *one* is the head (h) and the PP's nominal is

¹For more discussion and controversy, see Akhtar et al. (2004); Regier and Gahl (2004); Tomasello (2004); Lidz and Waxman (2004); Foraker et al. (2009); Pearl and Lidz (2009)

the dependent (d) (cf. Payne et al., 2013, 7–8). This demonstrates that *one* may appear with a complement PP, contrary to Baker’s claim.

(190) This interpretation is contrary to an accepted [*one* of wrestling] as a sport. {d is undergoer of h}

(191) Suddenly the river was full of plunging bodies going to the rescue, barking dogs and screaming girls mingling their cries with the masterful [*ones* of the menfolk]. {d is performer of h}

(192) ...she gently raised her eyebrows until her eyes met the disconcerted [*ones* of the team manager]. {d has body-part h}

(193) ...the tears, Dexter felt, were as much [*ones* of laughter] as of despair. {h has source d}

While this corpus investigation assumes that all *of*-PPs denote a complement relationship, Payne et al. (2013) explain that some of these dependents can indeed be interpreted as proper semantic complements. In the case of *the one of physics* in (188), the nominal *student* has the corresponding predicate *study* with an argument for what is studied, thus a proper complement. Similarly, in (190) the nominal *interpretation* has the predicate *interpret* with an argument for what is interpreted. This is the same for *cries* in (191). Therefore, these corpus examples show that the anaphor *one* does occur with complement PPs. This investigation shows that syntactic structure cannot reliably predict if a PP is a complement or modifier.

Semantics and frequency appear to play a larger role in the acceptability of *of*-PPs. There are many semantic relationships which may exist between the head and dependent of these phrases, such as *undergoer* and *source*. The exact type of relationship, Payne et al. (2013, 12) argue, “is determined by a mixture of world and contextual knowledge”. The *of*-PPs with relationships which occur more frequently tend to be considered complements, while the less frequent ones are modifiers. Payne et al. examined these frequencies in a corpus study and found that the *one* anaphor had no special effect on the frequencies of these relationships. Instead, these frequencies are a result of other factors affecting noun phrases in general. For instance, competing constructions like the genitive *'s* may be preferred over the *of*-PP: instead of *the eyes of the team manager*, *the*

team manager's eyes and in the case of anaphora simply *the team manager's*. Furthermore, the prepending construction like *the physics student* is preferred to *the student of physics*. Thus, Payne et al. (2013, 29) conclude that sentences like *the one of physics* are not ungrammatical, simply dispreferred given other alternatives.

Payne et al. conclude that Baker's premise is incorrect and that there is no data to support a complement-modifier distinction in syntactic structure. Thus, there is no evidence that there need to be any particular type branching structure in noun phrases. A flat analysis is equally plausible as semantics, context, and frequency determine the preference for certain constructions.

5.1.1.5 Complex Predicates

Abeillé and Godard (2002, 2010) examined the branching structure of complex predicates in French, which are multiple verbs that behave like a single verb. Tense auxiliaries and their verbal complements, like in (194), form such a complex predicate. This is shown by considering the location of clitics. Generally, a clitic attaches to the front of the verb that subcategories for it. However, with complex predicates the clitics “climb” to a dominating verb which is the head of the phrase. For instance, in (195a) the clitic *le* ‘it’ attaches to *a* ‘has’, the auxiliary, but the clitic may not precede *lu* ‘read’ like in (195b). Thus, clitic climbing shows that the auxiliary and its verbal complement form a complex predicate. There are then three possible syntactic structures a complex predicate and its complement could have: left branching, right branching, or flat, which are illustrated in Figure 5.3.

(194) Paul a lu Proust.
 Paul have.3SG read.PST.PTCP Proust.
 ‘Paul has read Proust.’

(195) a. Paul l’a lu.
 Paul it-have.3SG read.PST.PTCP
 b. *Paul a le lu.
 Paul have.3SG it read.PST.PTCP
 ‘Paul has read it.’

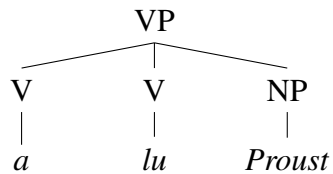
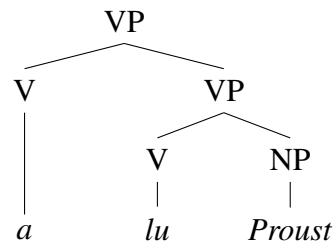
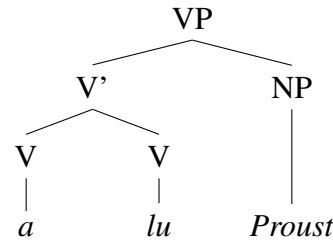

Figure 5.3: Possible structures of French VP with auxiliary verb.

Coordination like in (196) provides initial evidence about the structure of a complex predicate with a tense auxiliary. Abeillé and Godard (2002, 410) assume that coordination is elliptical and argue that French may only coordinate elements which are sister constituents. For instance, consider the non-constituent coordination in (197a) which conjoins accusative and dative object pairs, two sister constituents. But coordination is not possible in (197b) where the accusative object's PP is not a sister constituent of the dative object. Thus, this restriction requires that the participles and verbal complements in (196) be sister constituents. This is not the case for the left branching structure. Furthermore, Abeillé and Godard show that adverbs may be inserted in between the auxiliary and participle as in example (198). Cross-linguistically among Romance languages which have a left branching structure with strong verbal complexes like some variants of Spanish, such insertion and coordination like in (196) is not possible. So, Abeillé and Godard conclude that French cannot have a left branching complex predicate.

- (196) Paul a [parlé] [avec Marie] et [compris] [son erreur].
 Paul have.3SG speak.PST.PTCP with Marie and understand.PST.PTCP his mistake
 ‘Paul spoke with Marie and understood his mistake.’ Abeillé and Godard (2002, 407)
- (197) a. Jean donnera [le livre de Proust] [à Marie] et [le livre de Camus] [à
 Jean give.3SG.FUT the book of Proust to Marie and the book of Camus to
 Paul].
 Paul
 ‘Jean will give the book by Proust to Marie and the book by Camus to Paul.’ Abeillé
 and Godard (2002, 410)
- b. ??Jean donnera le livre [de Proust] [à Marie] et [de Camus] [à Paul].
 Jean give.3SG.FUT the book of Proust to Marie and of Camus to Paul
- (198) Paul a aujourd’hui favorablement répondu à notre demande.
 Paul have.3SG today favorably answer.PST.PTCP to our request
 ‘Paul has favorably answered our request.’ Abeillé and Godard (2002, 407)

The right branching structure likewise has difficulties in that it fails all constituency tests except coordination. For instance, Abeillé and Godard use the preposing test as a strong indicator of constituency. This test fails for a participle and its complement as in (199a). But for raising and control verbs, like in (199b), it is possible to prepose the complement structure.

- (199) a. *Compris son erreur, Paul ne (l’)a pas vraiment.
 understand.PST.PTCP his mistake, Paul PRT (it)-have.3SG not really.
 ‘Understood his mistake, Paul has not really.’
- b. Partir en vacances aujourd’hui, Jean (le) voudrait bien.
 leave.INF on vacation today Jean (it) like.3SG.SUBJ well
 ‘To go on vacation today, Jean would like to do.’ Abeillé and Godard (2002, 413)

Additionally, the flexibility of manner adverbs to shuffle among an auxiliary, the participle, and its complements pose further problems for a right branching structure. For instance, the adverb *verticalement* ‘vertically’ may appear between an auxiliary and the participle in (200a). If this were a right branching structure, then the adverb would either have to attach to the internal VP or to the auxiliary. If left adjunction of a VP were possible in auxiliary structures, then Abeillé and Godard argue that this should also be possible elsewhere. However, the sentence in (200b) shows that this is in fact not possible. Alternatively, if the adverb combined with the auxiliary,

then the auxiliary would acquire the manner semantics associated with the adverb. In coordination constructions where the auxiliary has wide scope over the conjuncts, like in (200c), both of the conjuncts would then also be subject to these semantics. However, the sentence in (200c) does not imply that the oil polluted the atmosphere vertically. Abeillé and Godard thus conclude that a right branching structure is also not appropriate for auxiliary structures.

- (200) a. Le pétrole a (verticalement) surgi (verticalement) du sol.
 the oil have.3SG (vertically) arise.PST.PTCP (vertically) from.the ground
 ‘The oil came vertically out of the ground.’
- b. *Il a vu le pétrole verticalement surgir de terre.
 he have.3SG see.PST.PTCP the oil vertically arise.INF of ground
 ‘He saw the oil come vertically out of the ground.’
- c. Le pétrole a verticalement surgi du sol et
 the oil have.3SG vertically arise.PST.PTCP from.the ground and
 pollué les couches successives de l’atmosphère.
 pollute.PST.PTCP the layers successive of the-atmosphere
 ‘The oil came vertically out from the ground and polluted the successive layers of the atmosphere.’ (Abeillé and Godard, 2002, 416–417)

A flat structure is the remaining possibility for French tense auxiliaries and their verbal complements. Abeillé and Godard (2002) thus argue that a flat analysis should be preferred over the other types of structures because it straightforwardly accounts for all of the discussed phenomena. In a flat structure, the participle and its complements are sister constituents and may license coordination. Furthermore, Abeillé and Godard analyze adverbs as complements of the verb that selects for them. These adverb complements may then freely appear between the auxiliary and participle in a flat structure. While French is not a V2 language like the ones investigated in this dissertation, it does show that flat structures exist in other linguistic phenomena.

5.1.1.6 Summary

In all in this section, I have considered the learnability of binary branching structures, the direction of branching, nominal complements and modifiers, and French complex predicates. Because flat structures are equally valid for these examples, reduce the abstract machinery, and draw more

adequate generalizations as in the case of linear order, the use of flat constituents is preferred in all cases except those where some type of branching or embedded structure is supported by empirical and observable evidence.

5.1.2 Cross-linguistic Branching Tendencies

Dryer (1992) observed in a large cross-linguistic study that there is a tendency for languages to seemingly prefer left or right branching structures. In this study, Dryer analyzed pairs of elements: verb patterners, which are lexical elements, and object patterners, which are phrasal elements. Such combinations may be a noun-genitive pair like *father + of John* or a verb-PP pair like *slept + on the floor*. There were strong tendencies for languages to order the patterners in the same way, thus producing consistent left or right-branching structures. Additionally, he proposed that these correlations exist because it is cognitively easier to process structures which uniformly branch in the same direction as formalized in the Branching Direction Theory (BDT).

Naturally, BDT requires widespread branching structures and precludes the use of flat structures. Acknowledging this dependency as his view on constituent structured changed to flatter, more descriptive analyses, Dryer (2008) later explains these word order correlations instead by appealing to semantic structure. That is, the patterners are semantic constituents rather than syntactic ones. This better aligns with the ultimate goal of sentence parsing, which is to assign meaning to an utterance. Structure and order only matter in as much as it aids in the interpretation of a clause and its corresponding semantic elements. So, processing difficulties only arise when there is difficulty in determining which clausal elements form coherent semantic structures. Thus, it is expected that languages will instead create internally uniform semantic processing schemes instead of purely syntactic ones based on branching.

It is easy to see how some verb and object patterner combinations reflect semantic units such as verb-object pairs like *ate + the sandwich* and noun-relative clause pairs like *movies + that we saw*, thus indicating that these “branching” tendencies are, in fact, tendencies in the ordering of semantic units (Dryer, 2008). However, other verb and object patterner combinations are less clearly like article-noun phrase pairs like *the + tall man* and complementizer-clause pairs like

that + John is sick. Hawkins (1994, 2004) accounts for these less clear cases by examining the *constituent recognition domains* (CRDs) of these structures. According to Hawkins' Principle, CRDs are defined by the distance from the beginning of a particular syntactic phrase, like a clause, to the nearest *mother-node constructing category* (MNCC), which signals the creation of a new sub-phrase. MNCCs are generally heads like nouns that indicate the construction of noun phrases, but may also be articles or complementizers that indicate the construction of a clause. Hawkins further states that if a phrase begins with a single word, then the CRD begins with that word, and similarly if the phrase ends with a single word, then the CRD ends with that word. The language processor will prefer constructions with shorter CRDs as they are cognitively easier to plan and easier to parse. So, it is this principle which accounts for the ordering of verb and object pattern combinations, not the type of syntactic branching structure.

To illustrate Hawkins' Principle, consider the noun phrases in Figure 5.4 discussed by Dryer (2008). In this example, the article alternately appears at the beginning or end of the clause. The article *the* and the relativizer *who* are MNCCs. So, the NP example which begins with the article will have a CRD which spans from the article to the relativizer. However, the NP which has the article at the end will have a CRD which spans the entire phrase because the phrase begins and ends with single words. So, the parser would prefer the structure with the smaller CRD.

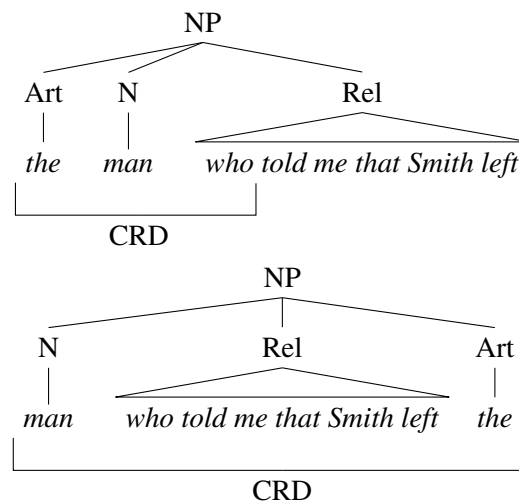

Figure 5.4: Examples of CRDs.

Dryer (2008) modifies his theory of word order based purely on syntactic structures to one that instead refers to semantic and cognitive difficulties: Clauses do not exhibit uniform branching structures because of syntactic considerations, but rather by the cognitive pressure to reduce complexity. The grouping of semantic units naturally causes elements to branch in the same direction. Mixing the order in which verb and object patterners combine increases these cognitive processing loads. So, the cross-linguistic branching patterns that Dryer has found do not dictate the use of branching syntactic structures, but instead describe non-syntactic constraints. A theory of flat syntax is then permitted under this theory. And because there is no evidence to add such complex branching structures to a theory of word order, they should not be included.

This cognitive-based explanation of sentence structure and acceptability is similar in spirit to Dependency Locality Theory developed by Gibson (2000). According to his theory, sentence acceptability can be measured by considering non-syntactic information like the frequency of words, the storage costs of lexical items in memory, and the plausibility of the potentially created structures. Gibson then verified these findings through human reading time experiments. His results contribute to the growing evidence that there are many non-syntactic factors which contribute to sentence processing. Thus, unnecessary structure and machinery should not be forced into syntax when it is better explained by other processes.

5.1.3 Summary

Many syntactic theories utilize deeply branching structures because they provide seemingly elegant solutions to phenomena like binding and certain types of anaphora. However, the complex structures posited by binary branching pose learnability issues and do not provide accounts for the phenomena which they were originally employed to explain. Furthermore, there is no overt evidence for the assumption that all structures must be binary. Thus, flat structures are more consistent with the observable facts, and cross-linguistic branching tendencies and biases are best explained in terms of semantic and cognitive factors.

5.2 Interacting Linear and Predicate Constructions

As a more plausible alternative to branching structures and the widespread use of extraction, I adopt a new surface-oriented approach to argument saturation and linear order. The core of the flat analysis described in this chapter assumes a division of labor between constructions that license grammatical dependencies (subordination, modification, coordination, etc.) and the linear order of constituents. This two-part approach to licensing clause structure in German, which has both flexible word order and strict verb second positioning, allows a few generalizations along both the linearization and verbal saturation dimensions to be identified.

I begin by conceptually describing the licensing of a simple sentence consisting of a single verb and its arguments in a main declarative clause like the example in (201)². This sentence contains a verb in the typical V2 position along with three verbal arguments, namely the nominative, accusative, and dative objects.

- (201) Ein Märchen **erzählt** er seiner Tochter.
 a fairy.tale tell.3SG.PRS he his.DAT daughter
 ‘He is telling his daughter a fairy tale.’

For this informal analysis, I use a simplified notation to define constructions. These constructions resemble typical phrase structure rules, but there are two major differences. First, as in HPSG, the arrow ‘ \rightarrow ’ has a model-theoretical interpretation. Hence, $A \rightarrow B$ does not mean “replace B with A”, rather, it means that any structure that satisfies the constraints expressed in A is the mother of the structures that satisfy the constraints in B. Consequently, more than one such rule can apply to the same local tree, as long as the imposed constraints are mutually consistent. Second, the elements on the right hand side of the arrow are surrounded by two types of brackets. If the elements are contained by angle brackets ‘ $\langle \rangle$ ’, then the elements are in a list and must appear in the exact order they are written. For instance, the rule in (202a) represents a single possible tree as shown in (202b).

²This sentence and its variants are often used by others such as Nerbonne (1994) and Müller (2005a).

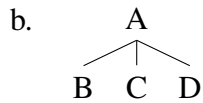
(202) a. $A \rightarrow \langle B, C, D \rangle$ 

Conversely, curly braces ‘{ }’ indicate that the elements may appear in any order, as shown in (203). So, the rule in (203a) licenses six possible trees.

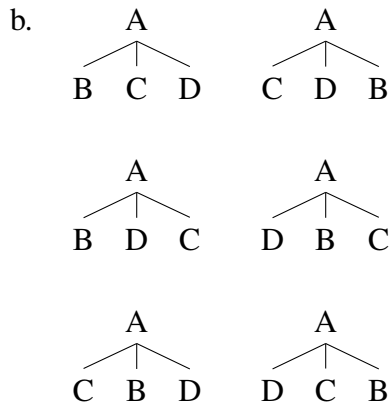
(203) a. $A \rightarrow \{B, C, D\}$ 

My analysis can now capture V2 sentences consisting of a single verb and any number of arguments, such as the one in (201), using a two-part approach which licenses linear order and valence constraints separately. First, the SIMPLE-LINEAR-V2 CONSTRUCTION, provided in (204), licenses linear order. This construction defines a clause where a finite verb must appear in the second position: The finite verb is preceded by an obligatory single element and followed by any number of n elements where $n \geq 0$. Each of these elements are syntactic constituents which may be different parts of speech. The V2 order of German clauses, as described in Chapter 2, allows non-finite verbal elements to be flexibly realized in most positions as long as the finite verb is in the second position, thus the elements are underspecified and can accommodate any type of element.

(204) SIMPLE-LINEAR-V2 CONSTRUCTION

$$V' \rightarrow \langle X, V[fin], X_1, \dots, X_n \rangle$$

Second, the saturation of the verb’s arguments is ensured by a general construction which may apply to a structure with any type of linear order, not just V2. This construction is formalized in (205) as the SIMPLE-PREDICATE CONSTRUCTION, which stipulates that a verb and its arguments

must be sisters. Crucially, however, the SIMPLE-PREDICATE CONSTRUCTION does not impose any ordering constraints and is therefore compatible with any linear ordering.

(205) SINGLE-PREDICATE CONSTRUCTION

$$V'[\text{VAL } \langle \rangle] \rightarrow \left\{ V[\text{VAL } \langle X_1, \dots, X_n \rangle], X_1, \dots, X_n \right\}$$

In the theory presented below, clauses will be defined in terms of a pair of constructions, one imposing linearization constraints, the other imposing constraints on argument realization. Because the linear order is underspecified and allows any non-verbal argument to appear in the first, third, and fourth positions and because the predicate construction makes no linear stipulations, the combination of these two constructions, in fact, licenses a variety of word orders. For instance, consider the verb *erzählen* ‘to give’ defined in (206) which may be realized in any of the valid clause structures in (207).

(206) $\left[\begin{array}{l} \textit{erzählen} \text{ ‘to give’} \\ \text{VAL } \langle \text{NP}[\textit{nom}], \text{NP}[\textit{acc}], \text{NP}[\textit{dat}] \rangle \end{array} \right]$

- (207) a. $[\text{NP } \textit{nom}], [\text{VERB } \textit{fin}], [\text{NP } \textit{acc}], [\text{NP } \textit{dat}]$
 b. $[\text{NP } \textit{nom}], [\text{VERB } \textit{fin}], [\text{NP } \textit{dat}], [\text{NP } \textit{acc}]$
 c. $[\text{NP } \textit{acc}], [\text{VERB } \textit{fin}], [\text{NP } \textit{nom}], [\text{NP } \textit{dat}]$
 d. $[\text{NP } \textit{acc}], [\text{VERB } \textit{fin}], [\text{NP } \textit{dat}], [\text{NP } \textit{nom}]$
 e. $[\text{NP } \textit{dat}], [\text{VERB } \textit{fin}], [\text{NP } \textit{nom}], [\text{NP } \textit{acc}]$
 f. $[\text{NP } \textit{dat}], [\text{VERB } \textit{fin}], [\text{NP } \textit{acc}], [\text{NP } \textit{nom}]$

Clauses of other word orders can also be licensed in the same way. Consider the verb initial sentence in (208).

(208) **Erzählt** er seiner Tochter ein Märchen?
 tell.3SG.PRS he his.DAT daughter a fairy.tale
 ‘Is he telling his daughter a fairy tale.’

Here there is the same predicate structure as before with a ditransitive verb, but the linear order can no longer be licensed by a V2 construction. Instead, the SIMPLE-LINEAR-V1 CONSTRUCTION

in (209) is required. This construction stipulates that the finite verb appears first followed by any number of elements.

(209) SIMPLE-LINEAR-V1 CONSTRUCTION

$$V' \rightarrow \langle V[fin], X_1, \dots, X_n \rangle$$

Thus, by combining the SIMPLE-LINEAR-V1 CONSTRUCTION with the SINGLE-PREDICATE CONSTRUCTION, a verb initial clause with a variety of word orders may be licensed as shown in (210).

- (210) a. [VERB *fin*], [NP *nom*], [NP *dat*], [NP *acc*]
 b. [VERB *fin*], [NP *nom*], [NP *acc*], [NP *dat*]
 c. [VERB *fin*], [NP *acc*], [NP *nom*], [NP *dat*]
 d. [VERB *fin*], [NP *acc*], [NP *dat*], [NP *nom*]
 e. [VERB *fin*], [NP *dat*], [NP *nom*], [NP *acc*]
 f. [VERB *fin*], [NP *dat*], [NP *acc*], [NP *nom*]

These constructions can be arranged in a multiple inheritance hierarchy as shown in Figure 5.5. All constructions are a type of *construct*, which are divided into PREDICATE and LINEAR CONSTRUCTIONS. A clause is then licensed by combining the constraints from one of each of these constructions, that is, a clause inherits the properties of multiple parent types. The sentence in (201) is a *simple-v2-clause* and the sentence in (208) a *simple-v1-clause*. Both of these clause types inherit the properties of the SINGLE-PREDICATE CONSTRUCTION but inherit different linear properties. Inheritance hierarchies are formally specified as implicational constraints as shown in (211) and (212). Both formats will be used in this dissertation. For more discussion on multiple inheritance see Carpenter (1992) and Sag et al. (2003).

(211) *simple-v1-clause* \Rightarrow *simple-v1-cxt* \wedge *single-predicate-cxt*

(212) *simple-v1-clause* \Rightarrow *simple-v2-cxt* \wedge *single-predicate-cxt*

So, by combining a particular LINEAR CONSTRUCTION with a PREDICATE CONSTRUCTION, it is possible to account for flexible word order, strict linear constraints, and argument saturation.

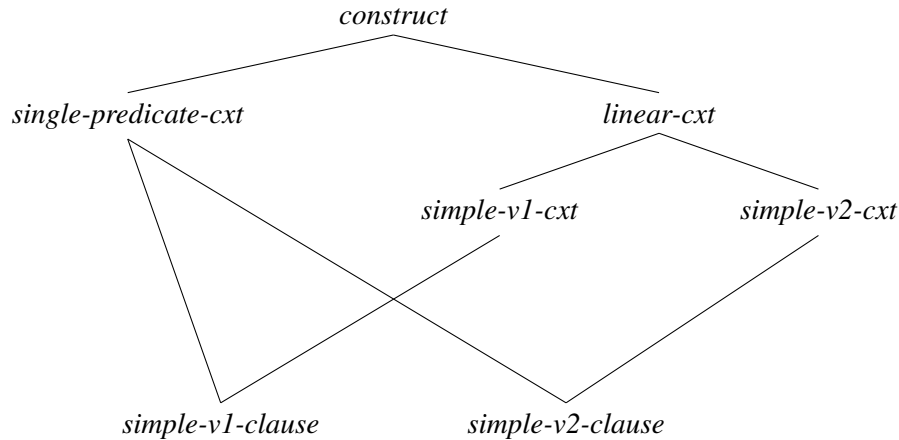

Figure 5.5: Sample hierarchy of combined linear and predicate constructions.

By dividing the constructions into two types, the number of constructions is greatly reduced in comparison to simply enumerating all possible orders as individual constructions. Furthermore, the LINEAR and PREDICATE CONSTRUCTIONS reflect readily observable properties and patterns of German clauses and do not require the support of underlying movement or extraction constructions. This account therefore dispenses with the non-observable machinery adopted by Reape and Kathol, such as word order domains.

The informal analysis in this section introduces the main mechanism for accounting for flexible word order with flat constructions, namely the interaction of LINEAR and PREDICATE CONSTRUCTIONS, each describing the two complementary dimensions of clause structure. In the remainder of this chapter I will provide a formal analysis with the full constructions for licensing German clauses with flexible word order, demonstrating that this flat analysis can indeed be applied across a wide variety of phenomena.

5.3 Formal Preliminaries

The SBCG formalism used throughout this chapter closely follows that described by Sag (2010) and Boas and Sag (2012). Of particular importance to the analyses of flexible word order, as seen in the previous chapter and in §5.2, is the interaction of various constructions, which are formally described as “the constraints on classes of signs and their components [and] are organized into a

regime (a lattice-like array of types and subtypes) that allows generalizations of varying granularity to be stated simply” (Boas and Sag, 2012, 5).

Constructions are defined by the combination of *daughter* signs to form a single *mother* sign, in a manner reminiscent of a tree structure, as described in §3.3. Sag (2010) defines the general type *linguistic object* which includes *signs* and *constructs*, as shown in Figure 5.6. A *sign* may in turn be a *phrase*, *word*, or *lexeme*. Generally, lexical constructions take *lexical-signs* and license new *words*, while phrasal constructions combine *expressions* to license new *phrases*.

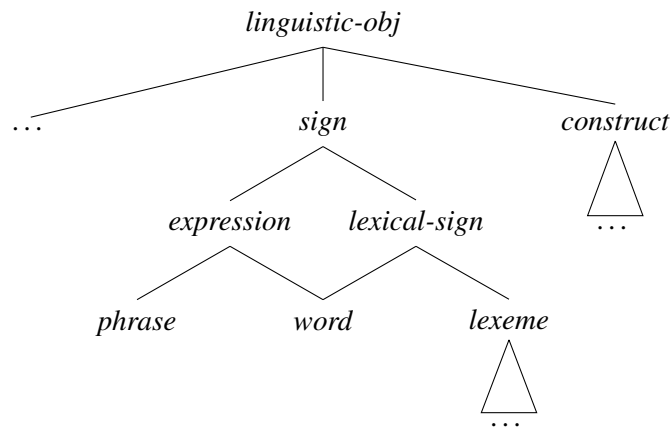

Figure 5.6: Partial hierarchy of *linguistic objects*.

All of the *linguistic objects* are typed feature structures and are fully consistent within a grammar and its type hierarchy, such as the *construct* in (213b). This feature structure corresponds to the traditional phrase structure representation in (213a). All of the structures proposed in this chapter adopt this kind of mother-daughter representation, although nothing truly hinges on this particular feature geometry.

$$(213) \quad \text{a. } S[Kim\ walks] \rightarrow NP[Kim] VP[walks]$$

$$\text{b. } \left[\begin{array}{l} \text{construct} \\ \text{MTR} \quad \left[\begin{array}{l} \text{phrase} \\ \text{FORM} \quad \langle Kim, walks \rangle \\ \text{SYN} \quad S[fin] \end{array} \right] \\ \text{DTRS} \quad \left\langle \left[\begin{array}{l} \text{word} \\ \text{FORM} \quad \langle Kim \rangle \\ \text{SYN} \quad NP[nom] \end{array} \right], H : \left[\begin{array}{l} \text{word} \\ \text{FORM} \quad \langle walks \rangle \\ \text{SYN} \quad VP[fin] \end{array} \right] \right\rangle \\ \text{HD-DTR} \quad H \end{array} \right]$$

Analyses of flexible word order may encounter difficulties when maintaining the proper semantics of an utterance while also liberating the linearization of elements. This problem is allegedly exacerbated by flat structures, such as those proposed here, where there are no longer levels of embedded structures to help disambiguate scoping. However, it will be shown in the following sections that flat structures can license the appropriate semantic scopes. I adopt the approach to semantics described by Sag (2012, §2.3.4) for SBCG which is a combination of Frame Semantics (Fillmore et al., 2003), common in Berkeley Construction Grammar, and Minimal Recursion Semantics (MRS) (Copestake et al., 2005).³ For example, consider the words *walk* and *Kim* shown in (214) and (215). The verb *walk* contributes a *walk-frame* which adds the semantics of a walking action performed by a walker. The noun *Kim* introduces an entity which could fulfill the walker role.

$$(214) \quad \left[\begin{array}{l} \text{word} \\ \text{FORM} \quad \langle walk \rangle \\ \text{SYN} \quad \left[\text{VAL} \quad \langle NP_i \rangle \right] \\ \text{SEM} \quad \left[\text{FRAMES} \quad \left\langle \left[\begin{array}{l} \text{walk-fr} \\ \text{LABEL} \quad l \\ \text{WALKER} \quad i \end{array} \right] \right\rangle \right] \end{array} \right]$$

³Alternatively, I could adopt the framework proposed by Klein and Sag (1985), in which the lambda terms of sister nodes are allowed to combine in a flexible way, as long as they are well-formed.

$$(215) \left[\begin{array}{l} \text{word} \\ \text{FORM} \langle \textit{Kim} \rangle \\ \text{SEM} \left[\text{FRAMES} \left\langle \left[\begin{array}{l} \textit{kim-fr} \\ \text{LABEL} \quad l \\ \text{ENTITY} \quad i \end{array} \right] \right\rangle \right] \end{array} \right]$$

These frames may be further extended to determine scope. For instance, the lexical entry for *today* in (216) contributes a semantic frame which takes scope over another frame with the label l_1 .

$$(216) \left[\begin{array}{l} \text{word} \\ \text{FORM} \langle \textit{today} \rangle \\ \text{SEM} \left[\text{FRAMES} \left\langle \left[\begin{array}{l} \textit{today-fr} \\ \text{LABEL} \quad l_0 \\ \text{SCOPE} \quad l_1 \end{array} \right] \right\rangle \right] \end{array} \right]$$

For all constructions, the MOTHER's frames are simply the concatenation, ' \oplus ', of the frames in the DAUGHTERS. Because all constructions are a subtype of *construct*, as illustrated in Figure 5.5, this composition may be described as a general constraint on all *constructs* as shown in (217).

(217) Principle of Compositionality (following Sag, 2012, 185)

$$\textit{construct} \Rightarrow \left[\begin{array}{l} \text{MTR} \left[\text{SEM} \left[\text{FRAMES} \quad L_0 \oplus \dots \oplus L_n \right] \right] \\ \text{DTRS} \left\langle \left[\text{SEM} \left[\text{FRAMES} \quad L_0 \right] \right], \dots, \left[\text{SEM} \left[\text{FRAMES} \quad L_n \right] \right] \right\rangle \end{array} \right]$$

Thus, it is possible to formalize the semantics of the sentence in (218a) containing the adverb *today*. Informally, there is some entity i who is both Kim and a walker, and *today* takes scope over the walking action as illustrated in (218b). This sentence's semantics are formalized with frames in (218c) where the scope has been resolved in the MOTHER. The constructions which license this structure constrain the resolution of the scope variables. Furthermore, the L(OCAL)TOP attribute signifies the highest scoped label in a set of frames. Here, l_0 must be higher than or equal to l_2 , the action frame. Effectively l_3 is the local top because it scopes over l_2 .

(218) a. Kim walks today.

b. Kim(i), today(walk(i))

$$\begin{array}{c}
 \text{c.} \\
 \left[\begin{array}{l}
 \text{MTR} \left[\begin{array}{l}
 \text{FORM} \langle \textit{Kim, walks, today} \rangle \\
 \text{SYN} \textit{VP}[\textit{fin}] \\
 \text{SEM} \left[\begin{array}{l}
 \text{LTOP} \quad l_{0 \geq 2} \\
 \text{FRAMES} \left\langle \left[\begin{array}{l} \textit{kim-fr} \\ \text{LABEL } l_1 \\ \text{ENTITY } i \end{array} \right], \left[\begin{array}{l} \textit{walk-fr} \\ \text{LABEL } l_2 \\ \text{WALKER } i \end{array} \right], \left[\begin{array}{l} \textit{today-fr} \\ \text{LABEL } l_3 \\ \text{SCOPE } l_{4=2} \end{array} \right] \right\rangle
 \end{array} \right] \\
 \text{DTRS} \left\langle \left[\begin{array}{l} \text{FORM} \langle \textit{Kim} \rangle \\ \text{SYN} \textit{NP}[\textit{nom}] \\ \text{SEM} \left[\text{F} \left\langle \left[\begin{array}{l} \textit{kim-fr} \\ \text{LABEL } l_1 \\ \text{ENTITY } i \end{array} \right] \right\rangle \right] \right], \left[\begin{array}{l} \text{FORM} \langle \textit{walks} \rangle \\ \text{SYN} \textit{VP}[\textit{fin}] \\ \text{SEM} \left[\text{F} \left\langle \left[\begin{array}{l} \textit{walk-fr} \\ \text{LABEL } l_2 \\ \text{WALKER } i \end{array} \right] \right\rangle \right] \right], \left[\begin{array}{l} \text{FORM} \langle \textit{today} \rangle \\ \text{SYN} \textit{ADV} \\ \text{SEM} \left[\text{F} \left\langle \left[\begin{array}{l} \textit{today-fr} \\ \text{LABEL } l_3 \\ \text{SCOPE } l_4 \end{array} \right] \right\rangle \right] \right] \right\rangle
 \end{array} \right]
 \end{array}
 \right.
 \end{array}
 \end{array}
 \end{array}
 \end{array}$$

MRS is particularly well suited to describe scoping ambiguities. However, it is only scoping issues with adverbs that are of particular importance for flexible word order, and I will not discuss more complex scoping phenomena. Moreover, I am not necessarily committed to MRS as a semantic representation but simply use it as one possible tool to describe semantic phenomena.

Modifiers, such as adjectives and determiners, are licensed by the HEAD-FUNCTOR CONSTRUCTION in (219). This construction licenses the combination of some functor (e.g. a modifier) and the head it selects. A functor's SELECT feature designates the type of head it may "mark", where the functor's MARKING value is assigned to the resulting licensed structure.

(219) HEAD-FUNCTOR-CXT (\uparrow *headed-cxt*) (Sag, 2012, 188)

$$\textit{head-func-cxt} \Rightarrow \left[\begin{array}{l}
 \text{MTR} \left[\text{SYN } X \left[\text{MRKG } M \right] \right] \\
 \text{DTRS} \left\langle \left[\text{SYN} \left[\begin{array}{l} \text{CAT} \left[\text{SELECT } Y \right] \\ \text{MRKG } M \end{array} \right] \right], Y : \left[\text{SYN } X \right] \right\rangle \\
 \text{HD-DTR } Y
 \end{array} \right]$$

For instance, consider the determiner *the* in (220) and the noun *book* in (221). The combination of these two words may be licensed by the HEAD-FUNCTOR CONSTRUCTION as illustrated in (222)

to form a noun phrase. This construction may be applied to any type of non-head which selects a head, as in, for example, adjectives selecting nominals, complementizers selecting clauses, and so on. The box around the structure indicates that it is a licensed construct and not a feature-structure definition.

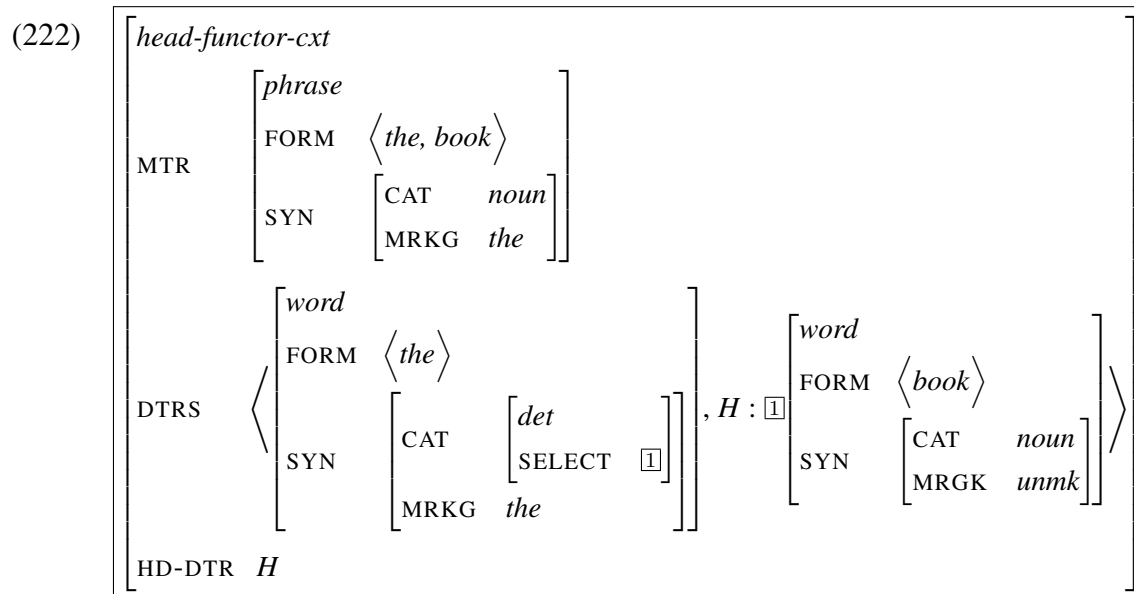
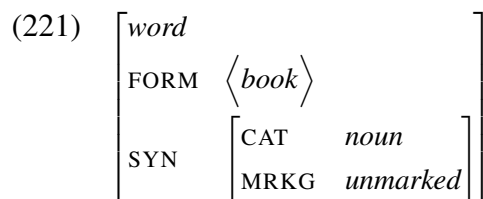
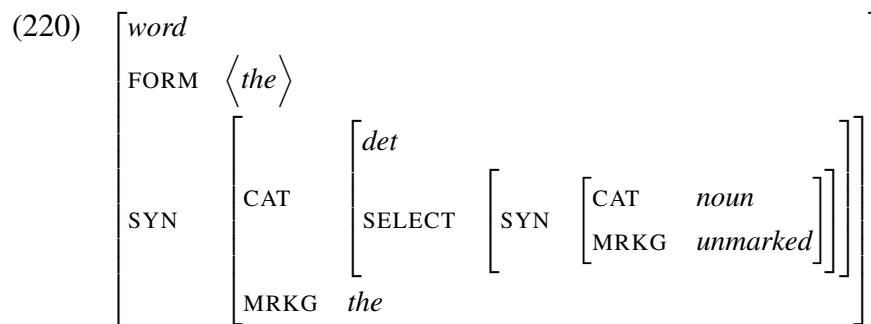

5.4 V2 Clauses

After describing the basic licensing of main declarative clauses in §5.4.1 and §5.4.2, I analyze partial verb phrases and their associated issues, particularly regarding case and agreement (cf.

Kathol, 2003), in §5.4.4. An extension of the grammar to handle adjuncts is provided along with the handling of adverbial scope in §5.4.5. In §5.4.6, an analysis for multiple pre-finite verbal elements (V3) is explored. Content questions, which are also V2, are described in §5.4.7. Finally, coordination is discussed in §5.4.8.

5.4.1 Single Predicate

A clause is licensed by the combination of a LINEAR and PREDICATE CONSTRUCTION. Here, I provide the corresponding formalization within my flat construction-based analysis for the sentence in (201) containing a single predicate, which is repeated in (223) along with its semantic components⁴.

- (223) a. Ein Märchen **erzählt** er seiner Tochter.
 a fairy.tale tell.3SG.PRS he his.DAT daughter
 ‘He is telling his daughter a fairy tale.’
- b. $he(i), a\text{-fairy-tale}(j), his\text{-daughter}(k), tell(i,j,k)$

The linear order of the elements in this V2 clause containing a single verbal predicate is modeled by the SIMPLE-V2 CONSTRUCTION in (224).⁵ This construction licenses the concatenation of any single sign before a finite verb, which is notated by the V(ERB)F(ORM) feature of the HD-DTR, followed by a list of signs as shown in the construction’s DTRS. Because a list may be of any size (in addition to being empty) this construction provides the flexibility to include any number of elements after the finite verb. The sign elements are also underspecified for type, so they may be any valid constituent such as noun phrases and adverbs. In essence, this construction only stipulates that a finite verb must be in the second position after a single sign. Generally, this construction belongs to the larger class of LINEAR CONSTRUCTIONS. This relationship is notated after the name

⁴A more complete description of the semantics may be: $he(i), some(j)(fairy\text{-tale}(j)), daughter(k), of(k,i), tell(i,j,k)$. However, for the discussion of flat structures and word order, I am primarily only concerned with how full noun phrase arguments combine with a predicate and shuffle within a clause. Particularly, I am only interested in how adverbs scope over predicates. So, I will gloss over this more complex semantic representation and show arguments as single units.

⁵All constructions will be defined in three different variants to make them more readable: 1) They are informally characterized in the simplified notation introduced in §5.2. 2) They are described in prose. 3) Finally, they are defined in the formal SBCG notation. Often the construction name preceding the SBCG notation will be abbreviated to save space but is identical to the title of construction definition.

of a construction where an arrow ‘ \uparrow ’ indicates the parent type.

(224) SIMPLE-V2 CONSTRUCTION (\uparrow *linear-cxt*)

- a. $V' \rightarrow \langle X, V[fin], X_1, \dots, X_n \rangle$
- b. A verbal structure may consist of at least two signs, the second of which must be a finite verb.

c.

$$simple\text{-}v2\text{-}cxt \Rightarrow \left[\begin{array}{l} \text{MTR} \quad \left[\text{SYN} \quad \left[\text{CAT} \quad Y \right] \right] \\ \text{DTRS} \quad \langle [sign], H \rangle \oplus list \\ \text{HD-DTR} \quad H : \left[\begin{array}{l} word \\ \text{SYN} \quad \left[\text{CAT} \quad Y : [VF \quad fin] \right] \end{array} \right] \end{array} \right]$$

Next, the combination of the finite verb and its arguments must be licensed with a PREDICATE CONSTRUCTION. Like other analyses in HPSG or SBCG, this type of constructions is similar to HEAD-COMPLEMENT CONSTRUCTIONS which license the combination of a predicate with its arguments. The example in (223) contains a single verbal predicate which combines with three arguments to form a complete clause. This saturation of arguments for the predicate is licensed by the SINGLE-PREDICATE CONSTRUCTION in (225). Here a finite verb combines with all of the arguments on its VALENCE list. The DTRS in this construction are defined by the resulting shuffle, ‘ \circ ’, of the verb and its arguments. Thus, this construction does not stipulate where the verb must be linearly in relation to its arguments: The verb could be first, second, last, or somewhere else in the middle. This shuffle operator is contrasted by the concatenation operator, ‘ \oplus ’, used in the SIMPLE-V2 CONSTRUCTION.

(225) SINGLE-PREDICATE CONSTRUCTION (\uparrow *predicate-cxt*)

- a. $V'[\text{VAL } \langle \rangle] \rightarrow \left\{ V[\text{VAL } \langle X_1, \dots, X_n \rangle], X_1, \dots, X_n \right\}$
- b. A saturated verbal structure may consist of a sequence of signs which contains a single finite verb and all of its valents. All the signs may appear in any order.

c.

$$single-pred-cxt \Rightarrow \left[\begin{array}{l} \text{MTR} \quad \left[\begin{array}{l} \text{SYN} \quad \left[\begin{array}{l} \text{CAT} \quad Y \\ \text{VAL} \quad \langle \rangle \end{array} \right] \\ \text{SEM} \quad \left[\begin{array}{l} \text{LTOP} \quad l_{0 \geq 1} \end{array} \right] \end{array} \right] \\ \text{DTRS} \quad \langle H \rangle \circ L \\ \text{HD-DTR} \quad H : \left[\begin{array}{l} \text{SYN} \quad \left[\begin{array}{l} \text{CAT} \quad Y : [\text{VF} \quad \textit{fin}] \\ \text{VAL} \quad L \end{array} \right] \\ \text{SEM} \quad \left[\begin{array}{l} \text{LTOP} \quad l_1 \end{array} \right] \end{array} \right] \end{array} \right]$$

Thus, the main declarative clause in (223) can be fully licensed by the combination of the SIMPLE-V2 and SINGLE-PREDICATE CONSTRUCTIONS. Moreover, I follow Kathol (2000, cf. Ch. 7) in assuming that “sentence mode” constructions define the semantic and discourse-oriented properties of various sentence types such as declarative, interrogative, imperative, etc. More specifically, I assume that a SENTENCE MODE CONSTRUCTION contributes semantic and pragmatic information to a clause by combining with the LINEAR and PREDICATE CONSTRUCTIONS. This is described by the constraint in (226), which states that simple main declarative clauses like (223) must satisfy three different constructional rules, each contributing different types of information.

(226) *simple-main-declarative-cl* \Rightarrow *simple-v2-cxt* \wedge *single-pred-cxt* \wedge *decl-cl*

The CLAUSE CONSTRUCTIONS contain general information about particular clause types. For instance, the DECLARATIVE-CLAUSE CONSTRUCTION in (227) stipulates that the type of message conveyed by the semantic object is *austinean*, that is, the clause is a ‘proposition’ or ‘outcome’ (Sag, 2010, 503). Additionally, this construction stipulates that no sign contains any syntactic variables associated with wh-interrogatives or relative pronouns, which is natural for a declarative clause. Alternatively, these CLAUSE CONSTRUCTIONS could contain the discourse information associated with each clause type. Truckenbrodt (2006) shows that the possible verb placements in

German clause are related to particular discourse contexts. These contexts are defined by indices like “deontic” and “epistemic”, which generally reflect the volitional speaker and the common ground. For instance, a declarative clause has the indices $\langle Deont_S, A, \langle Epist \rangle \rangle$ which means “S[peaker] wants from A[ddressee] that it is common ground . . .” (Truckenbrodt, 2006, 266).

I will not formalize all the CLAUSE CONSTRUCTIONS as their exact content is not necessary for the analysis presented in this chapter. Instead I assume standard definitions, such as the ones presented by Kathol (2000) or Sag (2010), and simply provide them in the analysis here so that it may be seen how sentence type information is incorporated into the analysis, similar to Kathol’s analysis of word order.

$$(227) \quad declarative-cl \Rightarrow \left[\begin{array}{l} \text{MTR} \quad \left[\text{SEM} \quad \text{austinean} \right] \\ \text{DTRS} \quad list \left(\left[\text{SYN} \quad \left[\begin{array}{l} \text{WH} \quad \{ \} \\ \text{REL} \quad \{ \} \end{array} \right] \right] \right) \end{array} \right]$$

(Sag, 2010, 535)

In all, there are three types of constructions needed to license a full clause:

- A PREDICATE CONSTRUCTION to license a verbal predicate and the saturation of its valents.
- A LINEAR CONSTRUCTION to license the linearization of all elements.
- A CLAUSE CONSTRUCTION to license clausal semantic and pragmatic information (imperative, declarative, or interrogative modes, information packaging, etc.)

Drawing from the constructional hierarchy in Sag (2012), these three types of constructions are types of PHRASAL CONSTRUCTIONS as illustrated in Figure 5.7. Furthermore, the PREDICATE and LINEAR CONSTRUCTIONS are types of HEADED CONSTRUCTIONS. The same CLAUSE CONSTRUCTIONS used in the domain-based analysis in Chapter 4 are also used here. Finally, adding the two constructions discussed in this section into this hierarchical structure, it is shown how the combination of the three types of constructions license a *simple-main-declarative clause*.

To illustrate the complete details of a fully licensed SIMPLE-MAIN-DECLARATIVE-CLAUSE CONSTRUCTION, consider Figure 5.8. Here, the example sentence in (223) has been represented

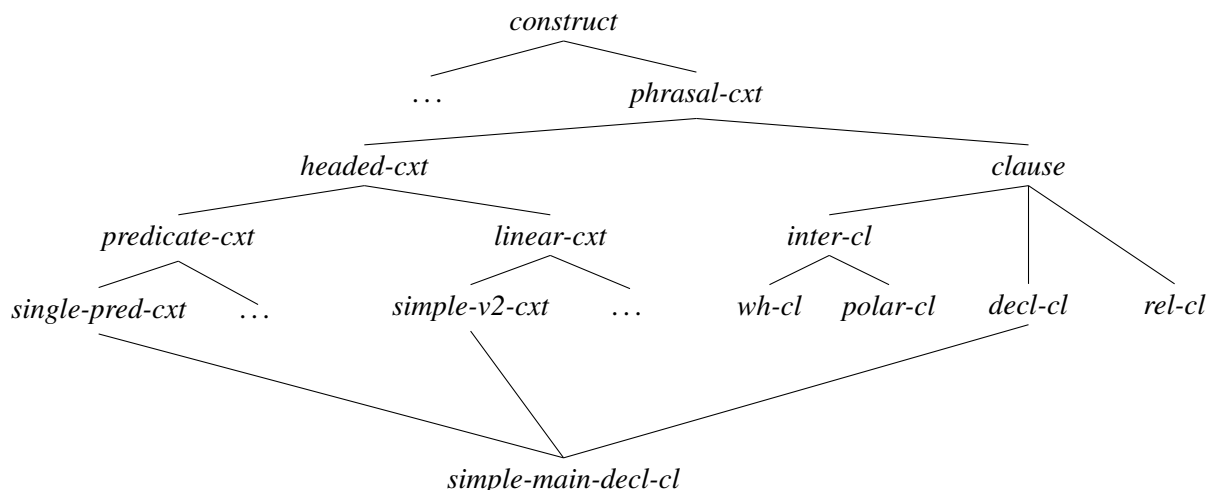

Figure 5.7: Initial partial type hierarchy of V2 constructions.

with all of its parts including pertinent feature structure specifications. The verb *erzählen* ‘tell’, defined in (228), is applied in the constructions along with three NP entities it subcategorizes for. The semantic features are not immediately crucial for my analysis, but will become important when handling adjuncts. So, for now they are included for completeness.

$$(228) \left[\begin{array}{l} \text{word} \\ \text{FORM} \langle \text{erzählen} \rangle \\ \text{SYN} \left[\text{VAL} \langle \text{NP}_i, \text{NP}_j, \text{NP}_k \rangle \right] \\ \text{SEM} \left[\text{FRAMES} \left\langle \left[\begin{array}{l} \text{telling-fr} \\ \text{TELLER} \quad i \\ \text{MESSAGE} \quad j \\ \text{RECIPIENT} \quad k \end{array} \right] \right\rangle \right] \end{array} \right]$$

Thus, the SIMPLE-V2 CONSTRUCTION in (224) and SINGLE-PREDICATE CONSTRUCTION in (225) combine to license a flat analysis of the basic V2 sentence in (223). Moreover, the combination of these constructions allows word order flexibility while maintaining the V2 word order. That is, the exact same constructions which are used in the parse in Figure 5.8 are also used for all other possible word orders of the utterance. Specifically, the variants in (229), which all have the same meaning and semantics, are licensed in same way as (223). The shuffle operator of the SINGLE-PREDICATE CONSTRUCTION allows the argument daughters to freely shuffle while the

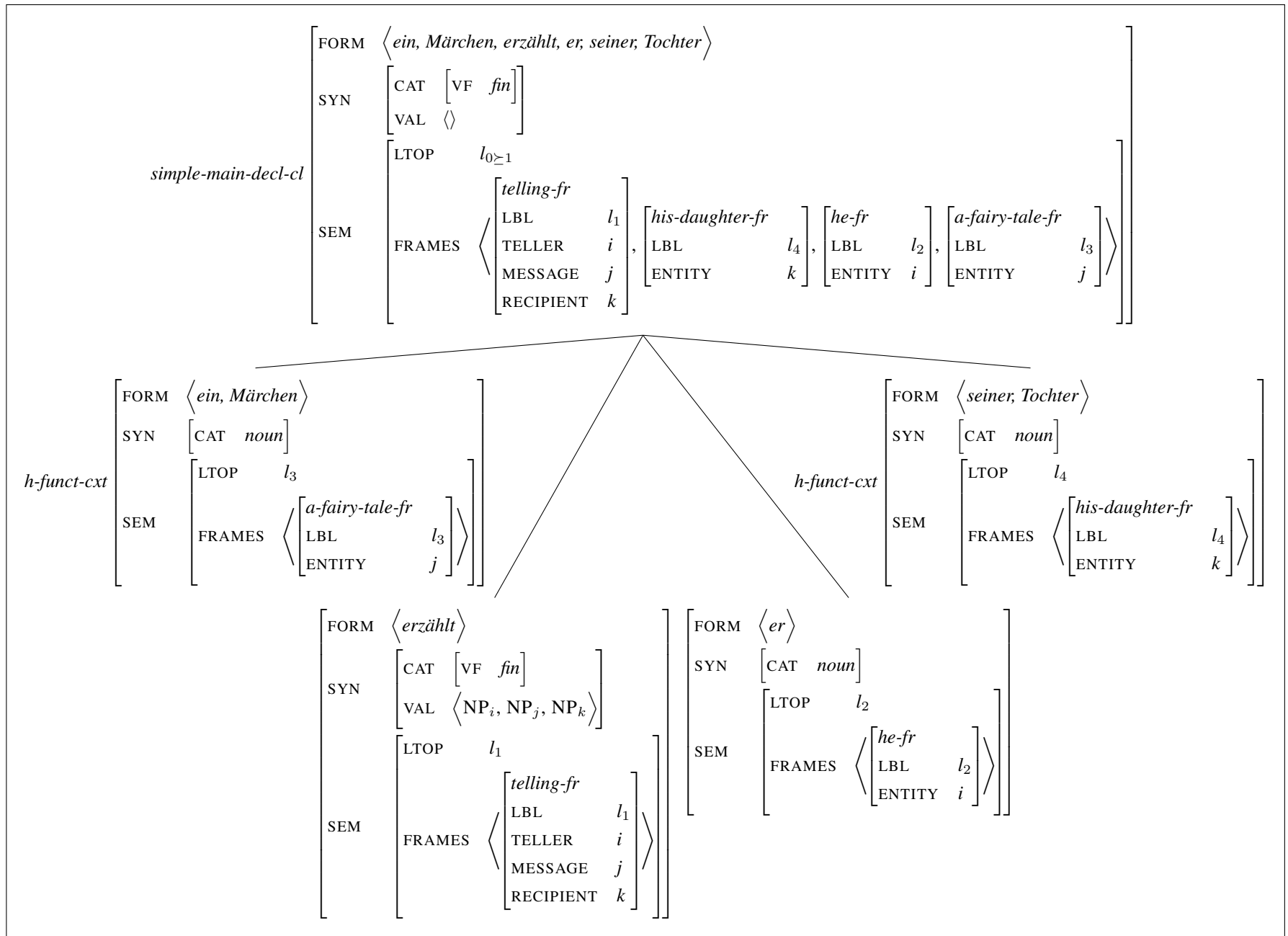

Figure 5.8: Flat syntactic structure for the single predicate V2 sentence in (223).

SIMPLE-V2 CONSTRUCTION underspecifies the location all the elements except the finite verb, which must be in the second position. So, the combination of these two constructions allows many valid word order realizations without any further stipulations.

- (229) a. Er **erzählt** seiner Tochter ein Märchen.
 he tell.3SG.PRS a fairy.tale his.DAT daughter
 ‘He is telling his daughter a fairy tale.’
- b. Seiner Tochter **erzählt** er ein Märchen.
 his.DAT daughter tell.3SG.PRS he a fairy.tale
 ‘He is telling his daughter a fairy tale.’
- c. $he(i), a\text{-fairy-tale}(x), his\text{-daughter}(k), tell(i, j, k)$

5.4.2 Multiple Predicates

In this section, I begin to describe more constructions in order to license a fuller array of sentence types. Namely, I expand the analysis to include sentences with multiple predicates including non-finite verbs such as past participles or infinitives. For instance, consider the multi-predicate sentence in (230). It contains a so-called *coherent* verbal construction in which the arguments of *erzählen* ‘to tell’ are absorbed into the valence list of *müssen* ‘must’, consequently creating a complex predicate, and single constituent, of the two elements. A standard account of this phenomenon involves the technique of argument composition, first applied to German verb clusters by Hinrichs and Nakazawa (1994, 1998). Argument composition allows all of the arguments of a verb to be raised to the verb which subcategorizes for it.

- (230) a. Ein Märchen **wird** er seiner Tochter [erzählen müssen].
 a fairy.tale will.3SG.PRS he his.DAT daughter tell.INF must.INF
 ‘He will have to tell his daughter a fairy tale.’
- b. $he(i), a\text{-fairy-tale}(x), his\text{-daughter}(k), future(must(tell(i, j, k)))$

Without argument composition, each verb would need to combine with its immediate complements before combining with an auxiliary verb. This resulting embedded structure, illustrated in Figure 5.9, would prevent all of the verbal arguments from shuffling. That is, the embedded structure would not allow *er* ‘he’ to shuffle with *seiner Tochter* ‘his daughter’ or *ein Märchen* ‘a

fairytale'. Specifically, all of the possible V2 linearizations of this sentence are shown in (231). Without argument composition only the first two linearizations would be possible while all six orders are valid.

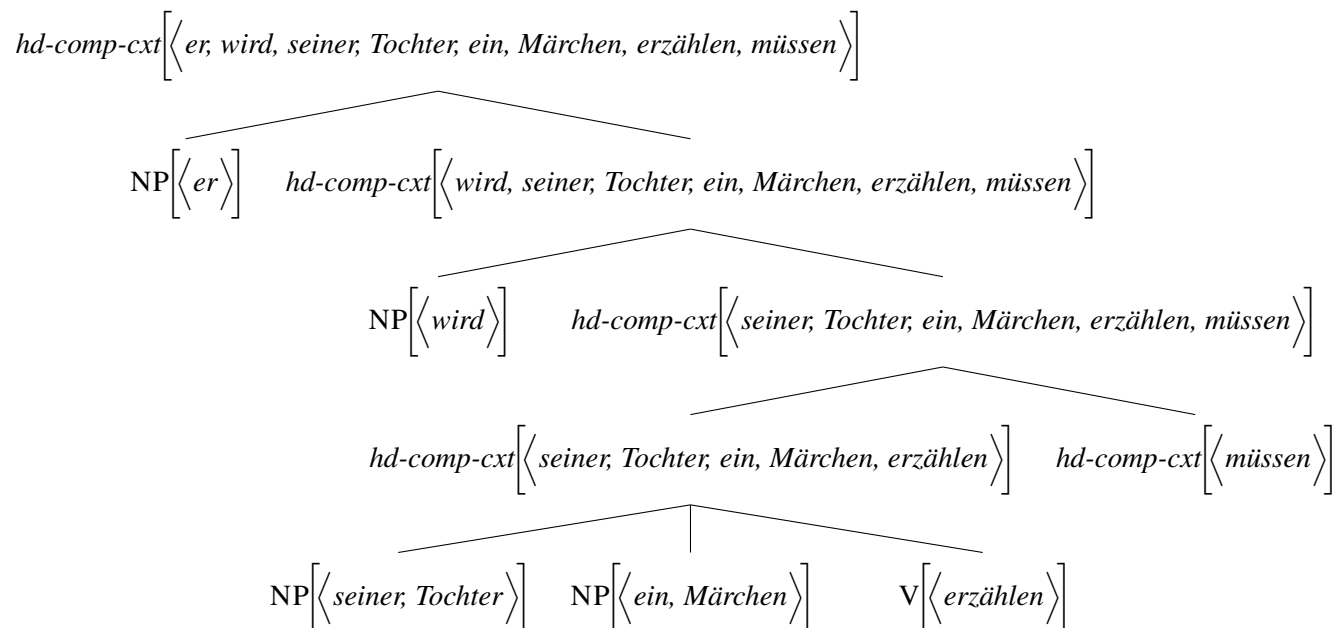

Figure 5.9: Clause structure of multiple predicates *without* argument composition.

- (231) a. Er wird seiner Tochter ein Märchen erzählen müssen.
 b. Er wird ein Märchen seiner Tochter erzählen müssen.
 c. Ein Märchen wird er seiner Tochter erzählen müssen.
 d. Ein Märchen wird seiner Tochter er erzählen müssen.
 e. Seiner Tochter wird er ein Märchen erzählen müssen.
 f. Seiner Tochter wird ein Märchen er erzählen müssen.

Instead, by using argument composition, this structure can be flattened by collecting all of the arguments in one verbal cluster. In this way, the arguments are combined with the predicate on the same level. Thus, I propose the COMPLEX-PREDICATE CONSTRUCTION in (232) to license the analysis of multiple predicates as a single constituent with combined arguments.

(232) COMPLEX-PREDICATE CONSTRUCTION (\uparrow *headed-cxt*)

$$a. V' \left[\text{VAL} \langle X, A_1, \dots, A_n, B_1, \dots, B_n \rangle \right] \rightarrow \left\{ V \left[\text{VAL} \langle X, A_1, \dots, A_n, \mathbb{1} \rangle \right], \mathbb{1}V \left[\begin{array}{l} \text{CAT} \quad [VF \quad nfin] \\ \text{VAL} \quad \langle X, B_1, \dots, B_n \rangle \end{array} \right] \right\}$$

- b. A verbal structure may consist of two verbal predicates, one a head and the other an unmarked, non-finite predicate. The resulting verbal structure subcategorizes for all of the valents of the two verbal daughters.

$$c. \left[\begin{array}{l} \text{MTR} \quad \left[\text{SYN} \left[\begin{array}{l} \text{CAT} \quad Y \\ \text{VAL} \quad \langle X \rangle \oplus L_1 \oplus L_2 \end{array} \right] \right] \\ \text{DTRS} \quad \langle H \rangle \circ \left\langle Z : \left[\text{SYN} \left[\begin{array}{l} \text{CAT} \quad [VF \quad nfin] \\ \text{MRKG} \quad none \\ \text{VAL} \quad \langle X \rangle \oplus L_2 \end{array} \right] \right] \right\rangle \\ \text{HD-DTR} \quad H : \left[\begin{array}{l} \text{word} \\ \text{SYN} \left[\begin{array}{l} \text{CAT} \quad Y : verb \\ \text{VAL} \quad \langle X \rangle \oplus (L_1 \circ \langle Z \rangle) \end{array} \right] \end{array} \right] \end{array} \right]$$

Notice that the COMPLEX-PREDICATE CONSTRUCTION licenses the combination of any verb that subcategorizes for a non-finite verb, which is expressed by the VF feature with the value *nfin*. The verb forms, such as *nfin*, are crucial for the analysis here as it is often specific forms of verbs which drive word order, such as V2, and predicate combination. The different types of possible verb forms are presented in Figure 5.10. There are two types of non-finite verb forms in this hierarchy: *base*, which describes any verb that is unchanged from its lexical entry, and *ptcp*, which is the participle form of a verb. Verbs may also be marked with a functor like *zu* ‘to’ in order to create infinitival structures. Such marked verbs have a MARKING value, which will be discussed in §5.6.3. Thus, the COMPLEX-PREDICATE CONSTRUCTION licenses the combination of any type of verb with a *nfin* verb which must be unmarked. In the case of the example in (230), it is two *base* verbs which form a complex predicate. In general, the head verb appears after the verb it subcategorizes for, but there are other allowable orders. I will not discuss the linearization

constraints of the verb cluster here and instead defer to previous analyses as discussed by Kathol (2000, Ch.8).

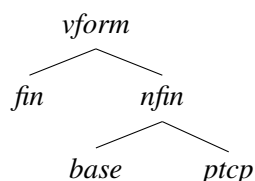

Figure 5.10: Type hierarchy of verb forms.

In most cases, this verbal cluster is the last element in a clause, however, some extraposed elements may appear after the verbal cluster. These elements have the feature `EXTRA(POSED) +` to distinguish them from other non-extraposed ones. I adopt this feature from Reape (1994) and Kathol and Pollard (1995). Generally, the `EXTRA` feature reflects information structure constraints on the elements which cause some to appear after the final verb cluster. So, this feature is not syntactic but pragmatic. The focus of the flat analysis here is not on extraposition, so the phenomenon will not be discussed in great detail. It suffices to say that all signs are `EXTRA -` unless explicitly specified as `+`, in which case they would be forced to the end of a clause. The constraint on the `construct` type in (233) ensures that all `EXTRA +` elements appear after `EXTRA -` ones.

$$(233) \quad \text{construct} \Rightarrow \left[\text{DTRS } \text{list}(\text{EXTRA } -) \oplus \text{list}(\text{EXTRA } +) \right]$$

It is often the case that subordinate clauses are extraposed as shown in (234). Here, the phrase *das Buch zu lesen* ‘to read the book’ appears after the non-finite verb in the extraposed position. However, in more restricted cases adjuncts or even arguments may appear extraposed. I further discuss subordinate clauses in §5.6.

- (234) Der Mann **hat** gestern versucht, [das Buch zu lesen].
 the man have.3SG.PRS yesterday try.PST.PTCP the book to read.INF
 ‘The man tried to read the book yesterday.’

Similar to the licensing of single predicate clauses described in §5.4.1, the structure of a multi-predicate clause is also licensed by the combination of two constructions. First, the `COMPLEX-V2`

CONSTRUCTION in (235) specifies the second position placement of the finite verb and the clause final placement of all other verbal elements, yet still before any extraposed elements.

(235) COMPLEX-V2 CONSTRUCTION (\uparrow *linear-cxt*)

$$\text{a. } V' \rightarrow \left\langle X_1, V \begin{bmatrix} \text{CAT} & [\text{VF } fn] \\ \text{VAL} & \langle \dots, \underline{1}, \dots \rangle \end{bmatrix}, X_2, \dots, X_i, \underline{1}V[nfn], X_{i+1}[\text{EXTRA } +], \dots, X_n[\text{EXTRA } +] \right\rangle$$

- b. A verbal structure may consist of a sequence of signs which contains two verbal predicates, a finite one which subcategorizes for the other non-finite one. The finite verb must be the second sign, and the non-finite predicate follows all signs but precedes any extraposed signs.

$$\text{c. } \text{complex-v2-cxt} \Rightarrow \left[\begin{array}{l} \text{MTR} \quad \left[\text{SYN} \quad \left[\text{CAT} \quad Y \right] \right] \\ \text{DTRS} \quad \left\langle \left[\text{sign} \right], H \right\rangle \oplus \text{list} \oplus \\ \left\langle Z : \left[\text{SYN} \left[\text{CAT} \quad \left[\text{VF } nfn \right] \right] \right] \right\rangle \oplus \text{list} \left(\left[\text{EXTRA } + \right] \right) \\ \text{HD-DTR} \quad H : \left[\begin{array}{l} \text{word} \\ \text{SYN} \quad \left[\text{CAT} \quad Y : \left[\text{VF } fn \right] \right] \\ \text{VAL} \quad \langle Z \rangle \circ \text{list} \end{array} \right] \end{array} \right]$$

Next, having constrained linear order, the saturation of the verbal arguments is licensed by the MULTI-PREDICATE CONSTRUCTION in (236). There are two verbal signs in this construction: the finite verb and the non-finite verbal complex. All non-finite verbs must appear as a single sign, which may be combined with the COMPLEX-PREDICATE CONSTRUCTION, described in (232). Additionally, the finite and non-finite verb signs share the same subject, as indicated by the shared first element on their VALENCE lists. As long as these selectional constraints are met, the two verbal signs, the subject, and the remaining verbal arguments may appear in any linear order.

(236) MULTI-PREDICATE CONSTRUCTION (\uparrow *predicate-cxt*)

- a. $V'[\text{VAL } \langle \rangle] \rightarrow \left\{ V[\text{VAL } \langle X_1, \mathbb{1} \rangle], \mathbb{1}V[\text{VAL } \langle X_1, X_2, \dots, X_n \rangle], X_1, \dots, X_n \right\}$
- b. A verbal structure may consist of a sequence of signs which contains two verbal predicates: One predicate subcategorizes for the other, which subcategorizes for the remaining signs. The predicates share the same subject. All of the signs may appear in any order.

c.

$$\begin{array}{c}
 \text{multi-pred-cxt} \Rightarrow \left[\begin{array}{c}
 \text{MTR} \quad \left[\begin{array}{c} \text{SYN} \quad \left[\begin{array}{c} \text{CAT} \quad Y \\ \text{VAL} \quad \langle \rangle \end{array} \right] \\ \text{SEM} \quad \left[\text{LTOP} \quad l_{0 \geq 1} \right] \end{array} \right] \\
 \text{DTRS} \quad \langle H \rangle \circ Z : \left[\begin{array}{c} \text{SYN} \quad \left[\begin{array}{c} \text{CAT} \quad \left[\text{VF} \quad nfin \right] \\ \text{VAL} \quad \langle X \rangle \oplus L \end{array} \right] \end{array} \right] \circ \langle X \rangle \circ L \\
 \text{HD-DTR} \quad H : \left[\begin{array}{c} \text{word} \\ \text{SYN} \quad \left[\begin{array}{c} \text{CAT} \quad Y : \left[\text{VF} \quad fin \right] \\ \text{VAL} \quad \langle X, Z \rangle \end{array} \right] \\ \text{SEM} \quad \left[\text{LTOP} \quad l_1 \right] \end{array} \right]
 \end{array} \right]
 \end{array}$$

Thus, by combining the linear constraints of the COMPLEX-V2 CONSTRUCTION with the selectional constraints of the MULTI-PREDICATE CONSTRUCTION, a complete V2 declarative clause with multiple predicates may be licensed, as formalized in (237).

$$(237) \quad \text{complex-main-declarative-cl} \Rightarrow \text{complex-v2-cxt} \wedge \text{multi-pred-cxt} \wedge \text{decl-cl}$$

The embedded complex predicate is licensed by the COMPLEX-PREDICATE CONSTRUCTION, which will then saturate one of the elements on the finite verb's VALENCE list. The whole clause is then licensed by the COMPLEX-MAIN-DECLARATIVE-CLAUSE CONSTRUCTION in (237), which is a combination of two types of constructions. The full parse of this sentence including all the technical details is depicted in Figure 5.11. This shows both the valence saturation as well as the semantic composition. In addition to the single predicate *erzählen* 'tell' from the previous section in (228), this parse includes non-finite variants of the verbs *müssen* 'must' and *werden*

‘will’ in (238) and (239). While *erzählen* contains the action semantics which includes the nominal arguments, the auxiliaries scope over the content verb.

$$(238) \left[\begin{array}{l} \text{word} \\ \text{FORM} \langle \text{müssen} \rangle \\ \text{SYN} \left[\text{VAL} \langle \text{NP}_i, \left[\begin{array}{l} \text{VAL} \langle \text{NP}_i \rangle \oplus \text{list} \\ \text{SEM} \left[\begin{array}{l} \text{LTOP} \\ l_1 \end{array} \right] \end{array} \right] \rangle \right] \\ \text{SEM} \left[\text{FRAMES} \left\langle \left[\begin{array}{l} \text{must-fr} \\ \text{SCOPE} \quad l_1 \end{array} \right] \right\rangle \right] \end{array} \right]$$

$$(239) \left[\begin{array}{l} \text{word} \\ \text{FORM} \langle \text{werden} \rangle \\ \text{SYN} \left[\text{VAL} \langle \text{NP}_i, \left[\begin{array}{l} \text{VAL} \langle \text{NP}_i \rangle \oplus \text{list} \\ \text{SEM} \left[\begin{array}{l} \text{LTOP} \\ l_1 \end{array} \right] \end{array} \right] \rangle \right] \\ \text{SEM} \left[\text{FRAMES} \left\langle \left[\begin{array}{l} \text{future-fr} \\ \text{SCOPE} \quad l_1 \end{array} \right] \right\rangle \right] \end{array} \right]$$

From the parse of this declarative clause with multiple predicates, it can be seen how a clause with complex interacting linear and selectional constraints can be licensed with relatively flat structures. Some embedded structures are necessary, such as for the licensing of complex predicates and noun phrases, however, all of these smaller constituents are combined in a flat manner to realize a complete clause. Not only has the sentence in example (230) been licensed in this flat manner, but all possible word order variations are also permitted by this analysis. That is, the nominal arguments in the sentence may be shuffled while maintaining the positions of the verbal constituents using the exact same constructions in (237): There is no need to explicitly list all possible linear combinations.

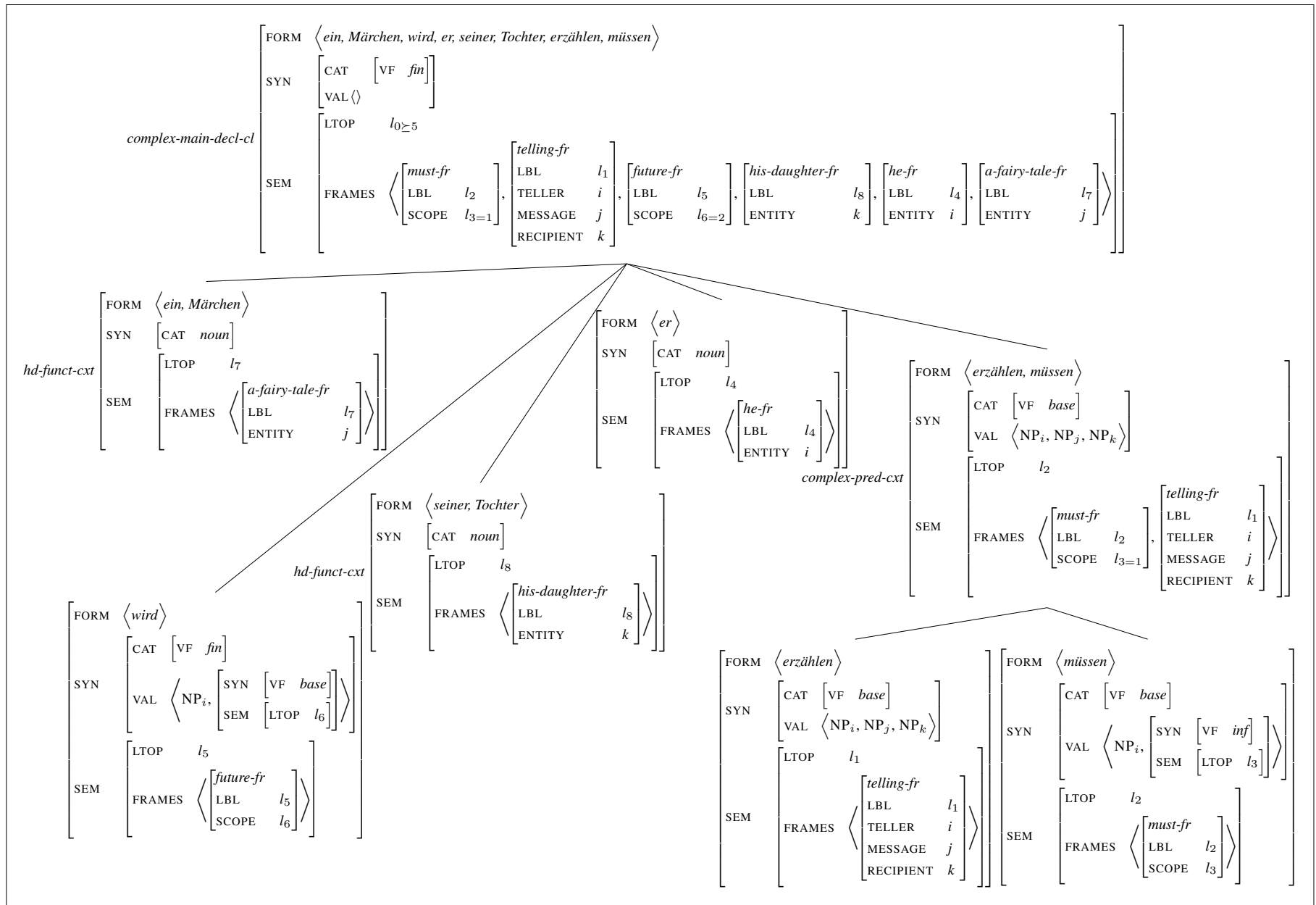

Figure 5.11: Flat syntactic structure for the multiple predicate V2 sentence in (230).

5.4.3 Interim Summary

In the previous two sections, I introduced the constructions needed to license basic V2 sentences consisting of verbal predicates and their arguments: the SIMPLE-V2, SINGLE-PREDICATE, COMPLEX-PREDICATE, COMPLEX-V2, and MULTI-PREDICATE CONSTRUCTIONS. The relationship between these constructions is illustrated by the type hierarchy in Figure 5.12. With them, it is possible to account for all basic main declarative clauses in German. This shows that flat, surface-oriented constructions can accurately describe clause structure in a flexible word order language without the need for a grammar that exhaustively enumerates all possible linearizations. This concise licensing of clauses with flexible word order is enabled by dividing clause licensing constructions into two groups: those which constrain the linear order and those which stipulate the saturation of arguments, namely LINEAR and PREDICATE CONSTRUCTIONS. There is no need to employ word order domains, traces, or extraction in order to model V2 order in a general way. All clauses must be licensed by some clause construction like the SIMPLE-MAIN-DECL and COMPLEX-MAIN-DECL-CLAUSE CONSTRUCTIONS. In the next sections, I will demonstrate how this flat analysis can be extended to account for more complex clauses and phenomena.

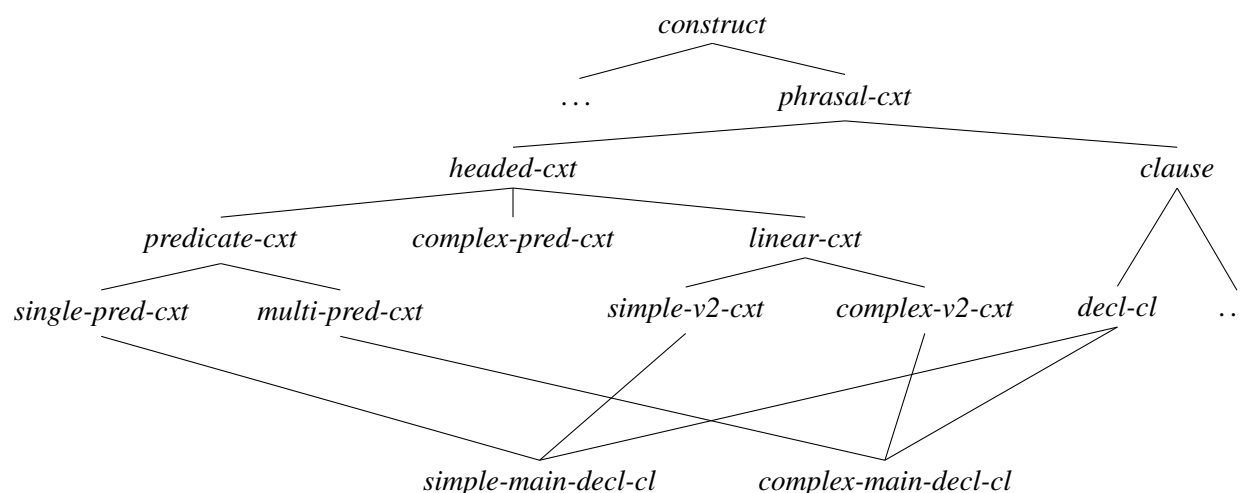

Figure 5.12: Expanded partial type hierarchy of V2 constructions.

The constructions proposed so far are repeated below for clarity.

(240) SIMPLE-V2 CONSTRUCTION (\uparrow *linear-cxt*)

$$simple-v2-cxt \Rightarrow \left[\begin{array}{l} \text{MTR} \quad \left[\text{SYN} \quad \left[\text{CAT} \quad Y \right] \right] \\ \text{DTRS} \quad \left\langle \left[\text{sign} \right], H \right\rangle \oplus list \\ \text{HD-DTR} \quad H : \left[\begin{array}{l} word \\ \text{SYN} \quad \left[\text{CAT} \quad Y : \left[\text{VF} \quad fin \right] \right] \end{array} \right] \end{array} \right]$$

(241) SINGLE-PREDICATE CONSTRUCTION (\uparrow *predicate-cxt*)

$$single-pred-cxt \Rightarrow \left[\begin{array}{l} \text{MTR} \quad \left[\begin{array}{l} \text{SYN} \quad \left[\text{CAT} \quad Y \right] \\ \text{VAL} \quad \langle \rangle \\ \text{SEM} \quad \left[\text{LTOP} \quad l_{0 \geq 1} \right] \end{array} \right] \\ \text{DTRS} \quad \langle H \rangle \circ L \\ \text{HD-DTR} \quad H : \left[\begin{array}{l} \text{SYN} \quad \left[\text{CAT} \quad Y : \left[\text{VF} \quad fin \right] \right] \\ \text{VAL} \quad L \\ \text{SEM} \quad \left[\text{LTOP} \quad l_1 \right] \end{array} \right] \end{array} \right]$$

(242) COMPLEX-PREDICATE CONSTRUCTION (\uparrow *headed-cxt*)

$$complex-pred-cxt \Rightarrow \left[\begin{array}{l} \text{MTR} \quad \left[\begin{array}{l} \text{SYN} \quad \left[\text{CAT} \quad Y \\ \text{VAL} \quad \langle X \rangle \oplus L_1 \oplus L_2 \end{array} \right] \right] \\ \text{DTRS} \quad \langle H \rangle \circ \left\langle Z : \left[\begin{array}{l} \text{SYN} \quad \left[\text{CAT} \quad \left[\text{VF} \quad nfin \right] \right] \\ \text{MRKG} \quad none \\ \text{VAL} \quad \langle X \rangle \oplus L_2 \end{array} \right] \right\rangle \\ \text{HD-DTR} \quad H : \left[\begin{array}{l} word \\ \text{SYN} \quad \left[\text{CAT} \quad Y : verb \\ \text{VAL} \quad \langle X \rangle \oplus \left(L_1 \circ \langle Z \rangle \right) \end{array} \right] \end{array} \right] \end{array} \right]$$

(243) COMPLEX-V2 CONSTRUCTION (\uparrow *linear-cxt*)

$$\text{complex-v2-cxt} \Rightarrow \left[\begin{array}{l} \text{MTR} \quad \left[\text{SYN} \left[\text{CAT} \quad Y \right] \right] \\ \text{DTRS} \quad \left\langle \left[\text{sign} \right], H \right\rangle \oplus \text{list} \oplus \\ \quad \left\langle Z : \left[\text{SYN} \left[\text{CAT} \quad \left[\text{VF} \quad \text{nfin} \right] \right] \right] \right\rangle \oplus \text{list} \left(\left[\text{EXTRA} + \right] \right) \\ \text{HD-DTR} \quad H : \left[\begin{array}{l} \text{word} \\ \text{SYN} \quad \left[\text{CAT} \quad Y : \left[\text{VF} \quad \text{fin} \right] \right] \\ \text{VAL} \quad \langle Z \rangle \circ \text{list} \end{array} \right] \end{array} \right]$$

(244) MULTI-PREDICATE CONSTRUCTION (\uparrow *predicate-cxt*)

$$\text{multi-pred-cxt} \Rightarrow \left[\begin{array}{l} \text{MTR} \quad \left[\begin{array}{l} \text{SYN} \quad \left[\text{CAT} \quad Y \right] \\ \text{VAL} \quad \langle \rangle \\ \text{SEM} \quad \left[\text{LTOP} \quad l_{0 \geq 1} \right] \end{array} \right] \\ \text{DTRS} \quad \langle H \rangle \circ Z : \left[\begin{array}{l} \text{SYN} \quad \left[\text{CAT} \quad \left[\text{VF} \quad \text{nfin} \right] \right] \\ \text{VAL} \quad \langle X \rangle \oplus L \end{array} \right] \circ \langle X \rangle \circ L \\ \text{HD-DTR} \quad H : \left[\begin{array}{l} \text{word} \\ \text{SYN} \quad \left[\text{CAT} \quad Y : \left[\text{VF} \quad \text{fin} \right] \right] \\ \text{VAL} \quad \langle X, Z \rangle \\ \text{SEM} \quad \left[\text{LTOP} \quad l_1 \right] \end{array} \right] \end{array} \right]$$

5.4.4 Partial Verb Phrases

A partial verb phrase consists of a non-finite verb and some of its arguments. Such phrases appear in the first position of a German clause as illustrated in (245), which is a variant of the sentence in (230). Such an ordering of elements requires the appropriate discourse context, such as contrastive focus. However, I will not discuss the discourse structures necessary to license such a construction here, rather I will limit the discussion to the syntactic constraints.

- (245) Ein Märchen erzählen **wird** er seiner Tochter.
a fairy.tale tell.INF will.3SG.PRS he his.DAT daughter
‘He will tell his daughter a fairy tale.’

This phenomenon is discussed by Kathol (2000, 233) in his construction-based analysis of German. However, that account assumes underlying binary branching structures where the fronted partial verb phrase is a single constituent which has been fronted via extraction, as an instance of a FILLER-GAP CONSTRUCTION. Nerbonne (1994) also provides an analysis of partial verb phrases but posits a flat sentence structure to allow flexible word order. Yet, like Kathol, he employs an extraction-based analysis of the first position and consequently posits a single partial verb phrase constituent only for the first position.

As shown below, it is not necessary to restructure the constituency of a clause in order to facilitate a partial verb phrase constituent in the first position. Such restructuring can have undesirable consequences on the way in which elements can combine and select for each other, particularly when it comes to agreement, which is discussed later in this section. Furthermore, restructuring often requires the extensive use of extraction as demonstrated by the analysis proposed by Müller (2005a,b). Instead, I propose that partial verb phrases should be treated simply as a linearization phenomenon, and analyses should not impose any constituency or combinatorial requirements. Unlike binary branching and extraction-based analyses, I argue that it is possible to account for partial verb phrase fronting solely with flat constructions.

The flat theory of syntax explored so far facilitates the description of partial verb phrase fronting as a purely linear phenomenon. So, I need only posit one new construction to account for the word order variation in (245), namely the SIMPLE-PARTIAL-VERB-PHRASE CONSTRUCTION in (246). Like the COMPLEX-V2 CONSTRUCTION in (243) above, which stipulates two linear positions for verbal predicates, this new construction licenses the appearance of an additional verbal element before the finite verb.

(246) SIMPLE-PARTIAL-VERB-PHRASE CONSTRUCTION (\uparrow linear-cxt)

- a.
$$V' \rightarrow \left\langle X_1, \dots, X_i, \boxed{1}V[nfn], V \begin{bmatrix} \text{CAT} & [VF \quad fn] \\ \text{VAL} & \langle \dots, \boxed{1}, \dots \rangle \end{bmatrix}, X_{i+1}, \dots, X_n \right\rangle$$
- b. A verbal structure may consist of a sequence of signs which contains two verbal predicates, a finite one which subcategorizes for the other non-finite one. The finite verb directly follows the non-finite predicate.
- c.
$$partial\text{-vp}\text{-cxt} \Rightarrow \left[\begin{array}{l} \text{MTR} \quad \left[\text{SYN} \quad \left[\text{CAT} \quad Y \right] \right] \\ \text{DTRS} \quad list \oplus \left\langle Z : \left[\text{SYN} \left[\text{CAT} \quad \left[VF \quad nfn \right] \right] \right], H \right\rangle \oplus list \\ \text{HD-DTR} \quad H : \left[\begin{array}{l} word \\ \text{SYN} \quad \left[\text{CAT} \quad Y : \left[VF \quad fn \right] \right] \\ \text{VAL} \quad \langle Z \rangle \circ list \end{array} \right] \end{array} \right]$$

So, similar to the manner in which a clause with multiple predicates is licensed, a clause with a fronted partial verb phrase is licensed by the combination of the MULTI-PREDICATE CONSTRUCTION and the newly introduced SIMPLE-PARTIAL-VERB-PHRASE CONSTRUCTION as formalized in (247). And as before, these constructions allow flexible order of the arguments. Notice that because clausal licensing is divided between constructions which constrain linear order and those which constrain argument selection, the MULTI-PREDICATION CONSTRUCTION is used with such partial verb phrase clauses as well as ordinary V2 clauses with multiple predicates. This construction reflects a generalization where the predicates have been split into two elements: the finite verb and the remaining non-finite verbs. The structure of the fully licensed sentence in (245) then has the form shown in (248).

(247) $simple\text{-partial}\text{-vp}\text{-cl} \Rightarrow simple\text{-partial}\text{-vp}\text{-cxt} \wedge multi\text{-pred}\text{-cxt} \wedge decl\text{-cl}$

(248)
$$\left[\begin{array}{l} simple\text{-partial}\text{-verb}\text{-phrase}\text{-cl} \\ \text{DTRS} \left\langle \boxed{3} \left[\langle ein, Mär. \rangle \right], \boxed{2} \left[\langle erzählen \rangle \right], \left[\text{SYN} \mid \text{VAL} \langle \boxed{1}, \boxed{3}, \boxed{4} \rangle \right], \left[\langle wird \rangle \right], \left[\text{SYN} \mid \text{VAL} \langle \boxed{1}, \boxed{2} \rangle \right], \boxed{1} \left[\langle er \rangle \right], \boxed{4} \left[\langle sein., Toch. \rangle \right] \right\rangle \end{array} \right]$$

This analysis of partial verb phrases, which does not utilize extraction, explains the inability of such phrases to appear non-locally. For instance, the sentence in (249) illustrates the ungrammaticality of a sentence where a partial verb phrase from an embedded clause appears in the first position of the matrix clause. Because extraction allows such long distance dependencies, as discussed in §3.6.3, it does not disallow this sentence without additional stipulations. The current flat analysis naturally disallows this type of non-local partial verb phrases.

- (249) *[Erzählen können]_i **hat** er gesagt, [dass der Babysitter den
tell.INF can.INF have.3SG he say.PST.PTCT that the.NOM babysitter the.DAT
Kindern ein Märchen _{-i} muss].
children a.ACC fairy.tale must.3SG
'He said, that the babysitter must be able to tell the children a fairy tale.' (Nerbonne, 1994, 147)

5.4.4.1 Split Non-finite Verbal Elements

The situation with fronted partial verb phrases becomes more complicated with the addition of even more predicates, which may appear at the end of the clause. For instance, consider the modified sentence in (250) which contains the modal *müssen* 'must' at the end of the clause. The double infinitives, which would usually form a complex predicate, have been split. Now there are three separate verbal positions for the finite verb and two different non-finite verbal elements.

- (250) Ein Märchen erzählen **wird** er seiner Tochter müssen.
a fairy.tale tell.INF will.3SG.PRS he his.DAT daughter must.INF
'He will have to tell his daughter a fairy tale.'

With this further division of the non-finite predicates, new constructions are necessary to license this more complex clause. First, the COMPLEX-PARTIAL-VERB-PHRASE CONSTRUCTION in (251) accounts for the linear order of a sentence with three distinct predicates: a finite verb and two non-finite verbal elements. The finite verb appears in the second position, the finite verb subcategorizes for a non-finite verbal element which appears at the end of the clause, and this non-finite verbal element subcategorizes for another non-finite verbal element which appears directly before the finite verb.

(251) COMPLEX-PARTIAL-VERB-PHRASE CONSTRUCTION (\uparrow linear-cxt)

$$\begin{aligned}
 \text{a. } V' \rightarrow & \left\langle X_1, \dots, X_i, \textcircled{2}V[nfin], V \begin{bmatrix} \text{CAT} & [VF \quad fin] \\ \text{VAL} & \langle \dots, \textcircled{1}, \dots \rangle \end{bmatrix}, X_{i+1}, \dots, X_j, \right. \\
 & \left. \textcircled{1}V \begin{bmatrix} \text{CAT} & [VF \quad nfin] \\ \text{VAL} & \langle \dots, \textcircled{2}, \dots \rangle \end{bmatrix}, X_{j+1}[\text{EXTRA } +], \dots, X_n[\text{EXTRA } +] \right\rangle
 \end{aligned}$$

- b. A verbal structure may consist of a sequence of signs which contains three verbal predicates: a finite one which subcategorizes for the first non-finite one, which itself subcategorizes for the second non-finite predicate. The finite verb directly follows the second non-finite predicate, and the first non-finite predicate follows all signs but precedes any extraposed signs.

$$\begin{aligned}
 \text{c. } & \left[\begin{array}{l} \text{MTR} \quad \left[\text{SYN} \quad \left[\text{CAT} \quad Y \right] \right] \\ \text{DTRS} \quad list \oplus \left\langle Z_2 : \left[\text{SYN} \left[\text{CAT} \quad [VF \quad nfin] \right] \right], H \right\rangle \oplus list \oplus \\ \text{complex-pvp-cxt} \Rightarrow \quad \left\langle Z_1 : \left[\text{SYN} \left[\begin{array}{l} \text{CAT} \quad [VF \quad nfin] \\ \text{VAL} \quad \langle Z_2 \rangle \circ list \end{array} \right] \right] \right\rangle \oplus list([\text{EXTRA } +]) \\ \text{HD-DTR} \quad H : \left[\begin{array}{l} \text{word} \\ \text{SYN} \quad \left[\text{CAT} \quad Y : [VF \quad fin] \right] \\ \text{VAL} \quad \langle Z_1 \rangle \circ list \end{array} \right] \end{array} \right]
 \end{aligned}$$

The MULTI-PREDICATE CONSTRUCTION cannot license the saturation of the verbal arguments in (250) because it requires that the non-finite verbs appear as a single constituent. Thus, I propose the SPLIT-MULIT-PREDICATE CONSTRUCTION in (252) to allow the argument saturation of structures which involve two non-finite predicates to appear as parts of two different constituents. These two predicates may be shuffled anywhere among the finite verb and the other elements. The three verbal elements are all connected in that they each require one of the others to be on their valence list. This creates a chain of verbal elements starting with the finite verb to the last non-finite element which then subcategorizes for all of the arguments.

(252) SPLIT-MULTI-PREDICATE CONSTRUCTION (\uparrow *predicate-cxt*)

- a. $V'[\text{VAL } \langle \rangle] \rightarrow$
 $\left\{ V[\text{VAL } \langle X_1, \textcircled{1} \rangle], \textcircled{1}V[\text{VAL } \langle X_1, \textcircled{2} \rangle], \textcircled{2}V[\text{VAL } \langle X_1, X_2, \dots, X_n \rangle], X_1, \dots, X_n \right\}$
- b. A verbal structure may consist of a sequence of signs which contains three verbal predicates: a finite one which subcategorizes for the first non-finite one, which itself subcategorizes for the second non-finite predicate, which subcategorizes for the remaining signs. The predicates share the same subject. All the signs may appear in any order.

c.

$$\text{split-multi-pred-cxt} \Rightarrow \left[\begin{array}{l} \text{MTR} \quad \left[\begin{array}{l} \text{SYN} \quad \left[\begin{array}{l} \text{CAT} \quad Y \\ \text{VAL} \quad \langle \rangle \end{array} \right] \\ \text{SEM} \quad \left[\text{LTOP} \quad l_{0 \geq 1} \right] \end{array} \right] \\ \\ \text{DTRS} \quad \langle H \rangle \circ Z_1 : \left[\begin{array}{l} \text{SYN} \quad \left[\begin{array}{l} \text{CAT} \quad \left[\text{VF} \quad nfin \right] \\ \text{VAL} \quad \langle X, Z_2 \rangle \end{array} \right] \\ \text{SEM} \quad \left[\text{LTOP} \quad l_{0 \geq 1} \right] \end{array} \right] \circ \\ \\ Z_2 : \left[\begin{array}{l} \text{SYN} \quad \left[\begin{array}{l} \text{CAT} \quad \left[\text{VF} \quad nfin \right] \\ \text{VAL} \quad \langle X \rangle \oplus L \end{array} \right] \\ \text{SEM} \quad \left[\text{LTOP} \quad l_1 \right] \end{array} \right] \circ \langle X \rangle \circ L \\ \\ \text{HD-DTR} \quad H : \left[\begin{array}{l} \text{word} \\ \text{SYN} \quad \left[\begin{array}{l} \text{CAT} \quad Y : \left[\text{VF} \quad fin \right] \\ \text{VAL} \quad \langle X, Z_1 \rangle \end{array} \right] \\ \text{SEM} \quad \left[\text{LTOP} \quad l_1 \right] \end{array} \right] \end{array} \right]$$

Using these two new constructions, it is now possible to license the sentence in (250) with the full clausal construction in (253). The structure of this licensed sentence is shown in (254).

(253) *complex-partial-vp-cl* \Rightarrow *complex-partial-vp-cxt* \wedge *split-multi-pred-cxt* \wedge *decl-cl*

(254)

$$\left[\begin{array}{l} \text{complex-partial-verb-phrase-cl} \\ \text{DTRS} \left\langle \textcircled{4} \left[\langle \text{ein}, M. \rangle \right], \textcircled{3} \left[\langle \text{erzählen} \rangle \right], \left[\langle \text{wird} \rangle \right], \textcircled{1} \left[\langle \text{er} \rangle \right], \textcircled{5} \left[\langle \text{sein}, T. \rangle \right], \textcircled{2} \left[\langle \text{müss.} \rangle \right] \right\rangle \\ \left[\text{S} \mid \text{V} \langle \textcircled{1}, \textcircled{4}, \textcircled{5} \rangle \right], \left[\text{S} \mid \text{V} \langle \textcircled{1}, \textcircled{2} \rangle \right] \end{array} \right]$$

Let us take stock. In order to handle the structure of the sentence in (250) with two non-finite predicates, I introduced a new LINEAR and PREDICATE CONSTRUCTION. Opponents of construction-based approaches would argue that this multiplication of constructions is undesirable. However, these additional constructions actually capture the fact that these cases of split non-finite predicates are often marginally acceptable to native speakers and are often avoided. That is, most speakers only have the SIMPLE-PARTIAL-VERB-PHRASE CONSTRUCTION and would find these split examples ungrammatical. Those speakers who do find the more complex split cases acceptable have learned the COMPLEX-PARTIAL-VERB-PHRASE CONSTRUCTION. Thus, the separation of the PARTIAL-VERB-PHRASE CONSTRUCTIONS is, in fact, a plausible division of the linguistic knowledge among German speakers.

5.4.4.2 Subject Agreement with Fronted Phrase

As mentioned earlier in this section, flat structure is particularly advantageous when the subject in the fronted partial verb phrase must agree with the finite verb in a later part of the clause. Following an approach taken in HPSG, subject-verb agreement can be constrained on all *verbal-lexemes*. This constraint in (255) enforces that the AGR(EEMENT) values of a verb, such as number and person, match those on its subject.

$$(255) \quad \textit{verbal-lexeme} \Rightarrow \left[\text{SYN} \left[\begin{array}{l} \text{CAT} \quad [\text{AGR} \quad Y] \\ \text{VAL} \quad \langle X : [\text{SYN} \quad [\text{CAT} \quad [\text{AGR} \quad Y]]] \rangle \oplus \textit{list} \end{array} \right] \right]$$

A verbal lexeme is later realized as a *word*, via standard lexical constructions, and saturated by some PREDICATE CONSTRUCTION. Nothing in this flat analysis hinges on the exact form of this agreement constraint, but it is crucial that this constraint may only apply if both the verb and subject are locally accessible. That is, they are both daughters in the same construction. This is particularly important for binary branching approaches, because as a verb combines with an argument, that argument is removed from its VALENCE list so that it is no longer accessible to subsequent constructions. So, if a subject is removed from the VALENCE list before the finite verb can enforce agreement, then the clause may not be licensed.

Kathol (2003) discusses the examples in (256), where the subject *ein Außenseiter* ‘an outsider’ must agree with the finite verb *hat* ‘has’. In other more deeply branching analyses, the partial verb phrase forms a single constituent, thus making the subject inaccessible to the finite verb, if locality is to be observed.

- (256) a. Ein Außenseiter gewonnen **hat** hier noch nie.
 a.NOM outsider.NOM.SG win.PTCP.PST have.3SG.PRS here still never
 ‘An outsider has never won here.’
- b. *Einen Außenseiter gewonnen **hat** hier noch nie.
 a.ACC outsider.ACC.SG win.PTCP.PST have.3SG.PRS here still never
- c. *Außenseiter gewonnen **hat** hier noch nie.
 outsider.PL win.PTCP.PST have.3SG.PRS here still never

That is, in a binary branching analysis where the fronted argument participates in a HEAD-FILLER CONSTRUCTION, the argument *ein Außenseiter* combines with the verb *gewonnen* ‘won’ and is removed from the verb’s VALENCE list, via standard HEAD-COMPLEMENT CONSTRUCTIONS. Thus, the subject is no longer available to constrain the *agr* feature of the finite verb in the HEAD-FILLER CONSTRUCTION. To illustrate this problem, consider the binary branching structure in Figure 5.13 which Kathol (2003, 94) suggests under his domain-based linearization analysis. The index $\boxed{1}$ stands for the VP consisting of the subject and non-finite verb. This VP has been slashed ‘/’, that is gapped, from the most deeply embedded VP where it would usually appear.

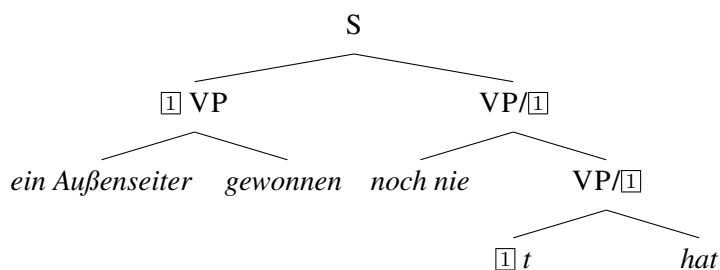

Figure 5.13: Binary branching structure of fronted partial verb phrase with subject.

To solve this problem, Kathol suggests including an additional attribute which contains the argument structure for verbs whose elements are not canceled off in HEAD-COMPLEMENT CON-

STRUCTIONS. This would then allow the subject’s information to be locally accessible to the finite verb in a HEAD-FILLER CONSTRUCTION before licensing the complete clause.⁶

With the flat constructions I proposed in this section, the subject is not in an embedded constituent and is still locally accessible to check agreement on the finite verb, thus avoiding this problem described by Kathol. The MULTI-PREDICATE and SPLIT-MULTI-PREDICATE CONSTRUCTIONS both locally ensure the saturation of the subject on the finite verb’s VALENCE list. In fact, these constructions do not even consider the linear location of the subject or verb. Rather, it is the PARTIAL-VERB-PHRASE CONSTRUCTIONS which require that any list of signs may appear before the fronted non-finite verb, including a subject. Thus, the problems with subject-verb agreement created by binary branching and extraction-based analyses, do not exist in the present flat construction-based analysis.

5.4.5 Adjuncts

Most syntactic theories posit a distinction between arguments and adjuncts, where arguments are often considered the obligatory elements of a predicate while adjuncts are optional. However, there may not be a simple binary argument-adjunct distinction, as argued by Dowty (2003, 60), instead they may only be “the two endpoints of a psycholinguistic ‘continuum’”, which he supports with evidence from language acquisition. Koenig et al. (2003) define two criteria for determining whether an element is an argument or adjunct of a particular verbal predicate: the Semantic Obligatoriness and Specificity Criteria. They further state in their Lexical Encoding Hypothesis that an element is an argument if and only if it satisfies both of these criteria. That is, if a particular element’s role must appear with any felicitous use of a predicate and that role is specific to a restricted class of predicates, then that element is an argument. The remaining elements are treated as adjuncts which modify the meaning of a predicate. This is captured in HPSG by the MOD feature (cf. Pollard and Sag, 1994) and in SBCG with the closely related SELECT feature described in §5.3, which allows certain non-heads like modifiers and determiners to impose constraints on the heads that they combine with.

⁶This solution is similar to the XARG feature in SBCG which is used to propagate information, like the subject, from embedded non-local structures (cf. Sag, 2012, §2.8.2).

A flat analysis easily handles the flexible ordering of arguments appearing on a predicate's VALENCE list, which reflect the realized elements from a predicate's ARG-STR list via linking constructions (cf. Davis and Koenig, 2000). Similarly, adjuncts must also be able to shuffle in a clause. For example, in (257), adapted from Kasper (1994, 39), the adverb *gestern* 'yesterday' may appear in nearly any position in a clause while maintaining the same semantic scope.

- (257) a. Sie **hat** (gestern) ihrem Mann (gestern) diese Geschichte (gestern)
 she have.3SG.PRS yesterday her husband yesterday this story yesterday
 erzählt.
 told
- b. Gestern **hat** sie ihrem Mann diese Geschichte erzählt.
- c. she(*x*), story(*y*), her-husband(*z*), yesterday(past(tell(*x*, *y*, *z*)))

In fact, Kasper (1994) argues that because the semantic scope of the adjuncts is not influenced by their linear order in a clause, that they should be analyzed as sisters of the verbal complements. This would allow adjuncts to shuffle with the arguments. There are two approaches to this type of analysis which are compatible with flat structure: constructionally or lexically-specified adjuncts.

5.4.5.1 Constructional Approach

In a constructional approach, most analyses posit a single adjunct construction or rule which allows an adjunct to combine with the element it modifies. Such a rule could be expressed as illustrated in (258), which is similar to the HEAD-FUNCTOR CONSTRUCTION in (219). However, these constructions crucially differ on the allowable order of the daughters. The HEAD-FUNCTOR CONSTRUCTION requires the functor to appear before the head, as is typical in determiner-noun or adjective-noun combinations. But adjuncts may appear both before and after the predicates they modify. Thus, the ADJUNCT CONSTRUCTION allows the adjuncts to shuffle with the predicate.⁷

⁷Uszkoreit (1987, 146) posits a similar rule in GPSG which can add an adjunct to a phrase with flat structure. Because such immediate dominance rules in GPSG do not encode word order, this adjunct may shuffle in the phrase. However, this approach is similar to the one based on word order domains, which I reject here.

(258) ADJUNCT CONSTRUCTION (\uparrow *headed-cxt*)

$$adjunct-cxt \Rightarrow \left[\begin{array}{l} \text{MTR} \quad \left[\text{SYN} \quad X \right] \\ \text{DTRS} \quad \langle H \rangle \circ list \left(\left[\text{SELECT} \quad H \right] \right) \\ \text{HD-DTR} \quad H : \left[\text{SYN} \quad X : \left[\text{CAT} \quad verb \right] \right] \end{array} \right]$$

This single construction works best in binary branching analyses, such as the one proposed by Müller (2005a), where the ADJUNCT and HEAD-COMPLEMENT CONSTRUCTIONS may be applied in arbitrary orders. For example, consider the verb final subordinate clause in (259) with the adjunct *gestern* ‘yesterday’ which may appear in any position in the clause.

(259) ... , dass (gestern) sie (gestern) ihrem Mann (gestern) diese Geschichte (gestern)
 COMP yesterday she yesterday her husband yesterday this story yesterday
 erzählt **hat**.
 told have.3SG.PRS
 ‘... , that she told her husband this story yesterday.’

A binary branching analysis would then license this clause by applications of the HEAD-COMPLEMENT and ADJUNCT CONSTRUCTIONS as illustrated in Figure 5.14. By changing the order in which these constructions are applied, the adverb *gestern* may be realized between any complements, thus allowing it to “shuffle” with the arguments.

However, I have argued that such binary branching structures are not desirable and instead posit flat PREDICATE CONSTRUCTIONS as described in the previous sections. In this case, a separate ADJUNCT CONSTRUCTION would be unable to allow adjuncts to shuffle throughout the clause. Consider Figure 5.15 which illustrates the licensing of the V2 sentence from (257) with an adjunct. First the MULTI-PREDICATE CONSTRUCTION licenses the clause without the adjunct and creates a single element. Then, the ADJUNCT CONSTRUCTION allows the adverb *gestern* to shuffle with this single element. Thus, the adverb may appear either at the beginning or end the clause, which are both ungrammatical positions. The clause in Figure 5.15, in fact, has an invalid word order.

Because *word order domains*, as used in my analysis in Chapter 4, are not utilized in the flat analysis here, the adverb *gestern* may not shuffle with the elements of the clause licensed by the COMPLEX-PREDICATE CONSTRUCTION. Thus, a single ADJUNCT CONSTRUCTION is not

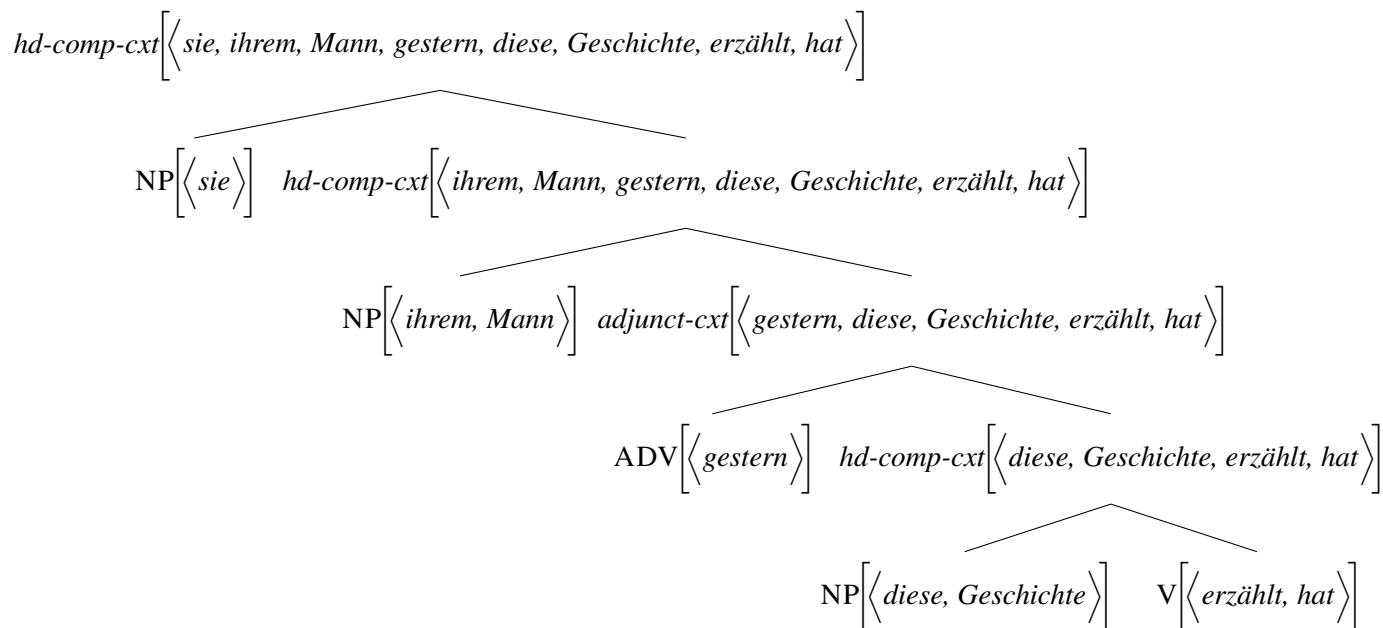

Figure 5.14: Binary branching structure with adjunct construction.

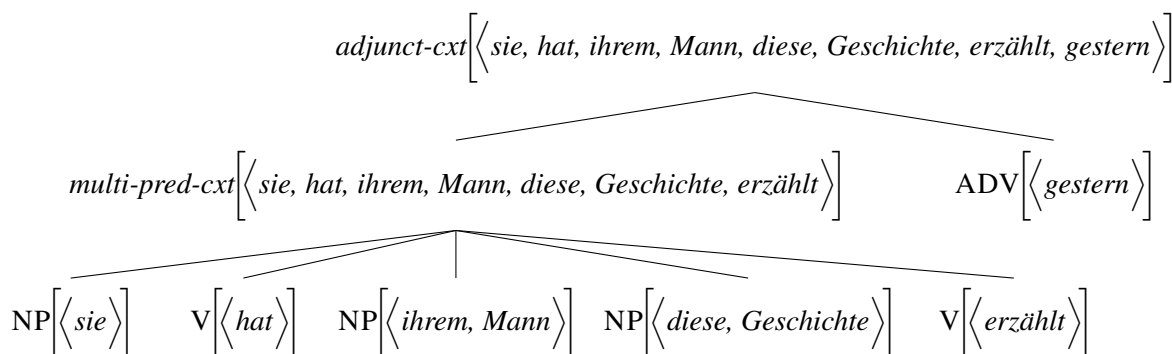

Figure 5.15: Flat structure with adjunct construction.

possible in a flat analysis.

Instead, adjuncts may be incorporated into the three PREDICATE CONSTRUCTIONS as demonstrated in (260). Here, the MULTI-PREDICATE CONSTRUCTION would be modified so that the DAUGHTERS include any number of elements which select for the head, the finite verb. Adverbs, as illustrated by *gestern* ‘yesterday’ in (261), additionally stipulate that they scope over the element they select for, i.e. the verb.

(260) MULTI-PREDICATE CONSTRUCTION (\uparrow *head-comp-cxt*) (modified from (236))

$$\text{a. } V'[\text{VAL } \langle \rangle] \rightarrow \left\{ \begin{array}{l} \text{[1]V}[\text{VAL } \langle X_1, \text{[2]} \rangle], \text{[2]V}[\text{VAL } \langle X_1, X_2, \dots, X_n \rangle], \\ X_1, \dots, X_n, Y_1[\text{SELECT [1]}], \dots, Y_i[\text{SELECT [1]}] \end{array} \right\}$$

b. A verbal structure may consist of a sequence of signs which contains two verbal predicates: One predicate subcategorizes for the other, which subcategorizes for the remaining signs except for those which select for the first predicate. The predicates share the same subject. All of the signs may appear in any order.

$$\text{c. } \left[\begin{array}{l} \text{MTR} \left[\begin{array}{l} \text{SYN} \left[\begin{array}{l} \text{CAT } Y \\ \text{VAL } \langle \rangle \end{array} \right] \\ \text{SEM} \left[\text{LTOP } l_{0 \geq 1} \right] \end{array} \right] \\ \text{DTRS} \langle H \rangle \circ Z : \left[\begin{array}{l} \text{SYN} \left[\begin{array}{l} \text{CAT } \left[\begin{array}{l} \text{VF } nfin \end{array} \right] \\ \text{VAL } \langle X \rangle \oplus L \end{array} \right] \end{array} \right] \circ \langle X \rangle \circ L \circ \\ \text{multi-pred-cxt} \Rightarrow \text{list} \left(\left[\begin{array}{l} \text{SYN} \left[\text{CAT } \left[\text{SELECT } H \right] \right] \end{array} \right] \right) \\ \text{HD-DTR } H : \left[\begin{array}{l} \text{word} \\ \text{SYN} \left[\begin{array}{l} \text{CAT } Y : \left[\text{VF } fin \right] \\ \text{VAL } \langle X, Z \rangle \end{array} \right] \\ \text{SEM} \left[\text{LTOP } l_1 \right] \end{array} \right] \end{array} \right]$$

$$(261) \left[\begin{array}{l} \text{word} \\ \text{FORM} \langle \textit{gestern} \rangle \\ \text{SYN} \left[\begin{array}{l} \text{CAT} \left[\text{SELECT} \left[\text{SEM} \left[\text{LTOP } l_1 \right] \right] \right] \right] \\ \text{SEM} \left[\text{FRAMES} \left\langle \left[\begin{array}{l} \textit{yesterday-fr} \\ \text{SCOPE } l_1 \end{array} \right] \right\rangle \right] \end{array} \right]$$

This same modification must also be made to the SINGLE-PREDICATE and SPLIT-MULTI-PREDICATE CONSTRUCTIONS to include a list of signs which select for the finite verb. Thus, these newly modified PREDICATE CONSTRUCTIONS can be combined with an appropriate LINEAR CONSTRUCTION (i.e. SIMPLE-V2, COMPLEX-V2) to license a clause with adjuncts. While

this modification of the three PREDICATE CONSTRUCTIONS allows adjuncts to correctly shuffle, it seems that a generalization is not being captured in this flat analysis.

This constructional account of adjuncts is not without problems. If adverbs are licensed constructionally, then there is no obvious way to allow for their extraction unless traces are postulated (Hukari and Levine, 1995; Levine, 2003), and further machinery must be employed to handle languages in which extraction pathways are overtly marked (Levine and Hukari, 2006). I now turn to a lexical approach of adjunction.

5.4.5.2 Lexical Approach

Drawing from Ginzburg and Sag (2000), Bouma et al. (2001), and Sag (2005), among others, I assume that a lexical constraint allows any number of modifiers to be located in the ARG-ST feature of lexemes. This account, in fact, abandons the notion of syntactic adjunction and assumes that modifiers are optional valents. As usual in HPSG, an argument realization rule is assumed to create words from lexemes by linking the members of ARG-ST to either VAL or GAP. In the former case, the arguments are realized locally, whereas in the latter they enter a long-distance dependency.⁸ Consider such a lexical construction in (262), which extends the ARG-ST list of a predicate to include any number of elements which select it. This construction is illustrated in (263) for the verb *erzählen* ‘to tell’.

(262) LEXICAL-MODIFIER CONSTRUCTION

$$lex-mod-cxt \Rightarrow \left[\begin{array}{l} \text{MTR} \quad \left[\text{ARG-ST} \quad L \oplus list \left(\left[\text{SELECT} \quad H \right] \right) \right] \\ \text{DTRS} \quad \left\langle H : \left[\text{ARG-ST} \quad L \right] \right\rangle \\ \text{HD-DTR} \quad H \end{array} \right]$$

⁸See Koenig and Davis (2006) for more discussion.

(263)

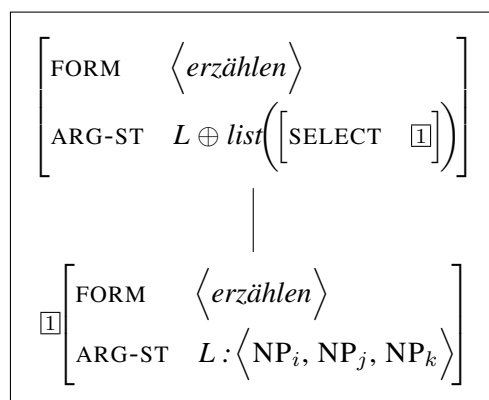

After a predicate's ARG-STR list has been extended to include any number of modifiers, then those modifiers will be realized to the VALENCE list via linking constructions. The modifiers can then appear as sisters to the predicate, just like other arguments, and shuffle in the usual fashion, as depicted in Figure 5.16. This type of lexical construction for verbs is compatible with the flat analysis that I have proposed here and would eliminate the need to modify the three different PREDICATE CONSTRUCTIONS, thus capturing a generalization about modifiers in a single construction.

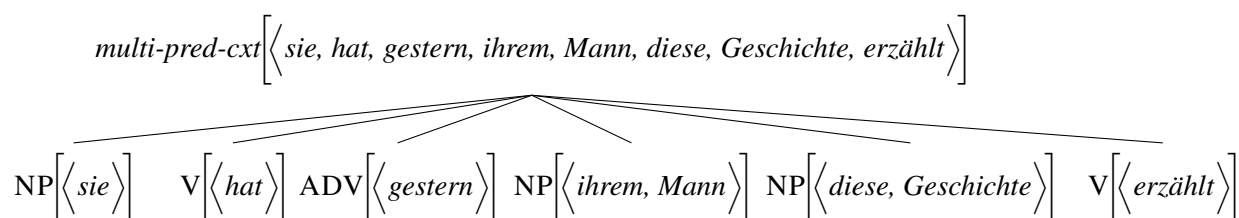

Figure 5.16: Flat structure with LEXICAL-MODIFIER CONSTRUCTION.

This lexical account is not without difficulties, however. Levine (2003) notes that conjunction allows an extracted adverb to scope over the entire coordination, as in (264). The modifier *in fifteen seconds flat* indicates the total time of all the conjuncts and is thus semantically shared by them. But if this modifier is licensed by a lexical rule, then each predicate individually realizes the modifier. Such cases of cumulation, however, can be handled by the integration of multiple modifiers in coordination constructions as described by Sato and Tam (2008) and Chaves (2009).

(264) Robin [[came in], [found a chair], [sat down], and [whipped off her logging boots]] [in fifteen seconds flat]. (Levine and Hukari, 2006, 153)

Therefore, I will assume a lexical approach which licenses modifiers in a single construction, subsequently allowing flexible word order just like with arguments, and allows modifier extraction as well as cumulation. In other cases of modification, like with negation, adjectives, or relative clauses, I do not assume such a lexical approach. Instead other constructions, like the HEAD-FUNCTOR CONSTRUCTION in (219) would handle these cases.

5.4.5.3 Semantic Scope

Without binary branching structures to stipulate which elements dominate over others, it may seem that flat structure encounters problems in the presence of multiple modifiers. For instance, consider the sentences in (265) each with two time expressions. These sentences are linear variants of each other and have the exact same meaning, despite the modifiers *täglich* ‘daily’ and *3 Stunden* ‘3 hours’ appearing in different orders. Logically, there are two possible scoping combinations of the adverbs, as illustrated in (266). However, only one is possible for both variants of the sentence. So, in fact, binary branching structure would not account for this scoping, because in (265b), *3 Stunden* necessarily dominates and thus incorrectly scopes over *täglich* assuming a right branching structure.

- (265) a. Peter **hat** täglich 3 Stunden lang trainiert.
 Peter have.3SG.PRS daily 3 hours long train.PTCP.PST
 b. Peter **hat** 3 Stunden lang täglich trainiert.

‘Peter trained daily for 3 hours.’ (Kasper, 1994, 45)

- (266) a. $\text{peter}(x), \text{daily}(3\text{-hour}(\text{past}(\text{train}(x))))$
 b. $\# \text{peter}(x), 3\text{-hour}(\text{daily}(\text{past}(\text{train}(x))))$

The MRS account used with my analysis allows both scoping possibilities of the adverbs. That is, the lexical entries for modifiers, as illustrated in (261), stipulate that they scope over the element they select for, namely the finite verb. If there are multiple modifiers, then they all scope over the

finite verb, but the order in which they scope over the verb is left underspecified. Furthermore, if one more closely inspects the two possible semantic interpretations, only one is semantically felicitous and plausible: One cannot perform an action daily within a three hour time period as indicated in (266b). Thus, it is not the syntactic structure which renders this variant ungrammatical, but rather non-configurational constraints on possible real world events.

Similarly, the sentence in (267) with two modifiers, *ab und zu* ‘occasionally’ and *eine Stunde* ‘an hour’, has two possible semantic interpretations for a single word order, shown in (268), enabled by the underspecified MRS semantic representations. In this case, the sentence is, in fact, truly ambiguous as both scoping variants are plausible despite a single word order. The modifiers could be shuffled throughout the sentence and the possible semantic interpretations would remain the same. Binary branching analyses often rely on the branching structure to determine scoping, which means a single word order may incorrectly only have one possible modifier scoping.

(267) Das Baby **hat** ab und zu eine Stunde lang geheult.
 the baby have.3SG.PRS occasionally a hour long cry.PTCP.PST
 ‘The baby cried occasionally for one hour.’ (Kasper, 1994, 49)

(268) a. baby(x), occasionally(one-hour(past(cry(x))))
 b. baby(x), one-hour(occasionally(past(cry(x))))

In all, this shows that flat constructions not only correctly license adjuncts but also account for their associated semantic scoping possibilities.

5.4.6 Verb Third

In so-called verb third constructions, there are two constituents before the finite verb, thus placing the finite verb in the third position. These types of clauses have the exact same characteristics as V2 clauses except that they have an additional element before the finite verb.

Verb third ordering may only occur in very specific contexts which are not fully understood. A comprehensive study examining many possible types of first elements was undertaken by Müller (2003, 2005b). He finds many commonalities among the possible pairings of first elements. For instance, a subject and adverb may appear together as in sentence (269). Here, these two constituents

precede the finite verb *lassen* ‘let’. Similarly, two prepositional phrases often appear together in the first positions as with example (270). Additionally there could be a dative argument with a prepositional phrase like sentence (271).

- (269) [Alle Träume] [gleichzeitig] **lassen** sich nur selten verwirklichen.
 all dreams simultaneously let.3PL.PRS self.3PL only seldom realize.INF
 ‘All dreams are seldom realized at the same time.’
- (270) [Zu ihren Eltern] [nach Stuttgart] **ist** sie gefahren.
 to her parents to Stuttgart be.3SG.PRS she drive.PST.PTCP
 ‘She drove to her parents in Stuttgart.’
- (271) [Der Universität] [zum Jubiläum] **gratulierte** auch
 the.SG.DAT university to.the.SG.DAT anniversary congratulate.3SG.PRS also
 Bundesminister Dorothee Wilms, ...
 federal.minister Dorothee Wilms
 ‘Minister Dorothee Wilms also congratulated the university on its anniversary, ...’

Müller provides examples of many such categories of elements which may appear together before the finite verb and realize verb third word ordering. However, these observed pairings of elements are not productive rules which may be applied in any context. Instead, there are many constraints on the occurrence of verb third which often appear to be discourse-pragmatic in nature as well as idiomatic. Thus, instead of analyzing the phenomenon of verb third as a productive syntactic process as Müller does, I find that it is more appropriate to define individual constructions for the various types of pre-verbal elements.

For instance, consider the verb third sentence in (272), where the finite verb appears after a prepositional phrase and the accusative object. This example was discussed in §3.4.2 and showed how the extraction-based account proposed by Müller (2003, 2005b) posited a single new empty-headed verbal constituent consisting of the first two elements and consequently posits many trace/empty elements.

- (272) [Zum zweiten Mal] [die Weltmeisterschaft] **errang** Clark 1995
 to.the second time the world.championship win.1SG.PST Clark 1995
 ‘Clark won the world championship for the second time in 1995.’ (Müller, 2005b)

Due to the apparent idiomatic nature of many verb third word orderings, an overly productive mechanism such as the extraction-based account (among other reasons discussed in Chapter 3) does not seem appropriate. Instead, I capture the highly constrained contexts of verb third with individual constructions. Because verb third word order is only a linear phenomenon, under my analysis I only need to define new LINEAR CONSTRUCTIONS. The existing PREDICATE CONSTRUCTIONS already appropriately license the selection and saturation of verbal arguments and adjuncts.

Similar to the domain-based analysis in Chapter 4, the verb third word order in (272) may be licensed by defining a construction like the SIMPLE-V2 CONSTRUCTION but where multiple elements are permitted before the finite verb. To show how the external factors affect the limited contexts in which these constructions may occur, I tentatively posit some discourse prominence feature which licenses this multiple fronting. This new PROM(INENCE) feature indicates that some non-syntactic, information structure-oriented importance has been given to the constituent. Thus, the new SIMPLE-DISOURSE-PROMINENCE CONSTRUCTION in (273) is provided as an example of how verb third word ordering is licensed under my analysis. This construction then combines with the SINGLE-PREDICATE CONSTRUCTION in (241) to license a full clause as formalized in (274). A similar prominence construction can also be defined for multiple verbal predicates. Yet, the prominence construction presented here should only be taken as an example of how such word ordering is licensed by incorporating discourse-oriented features and should not be considered a full analysis of the phenomenon.⁹

⁹Alternatively, Cook (2014) suggests that V3 structures are licensed by “collocational chunks”, which consist of the pre-verbal elements and the verb. Under such an approach, highly correlated elements may appear before the finite verb as a constituent, similar to the V3 analysis of Müller (2005b). While I argue against such a constituency in this dissertation, the COLLOCATION features Cook proposes capture the non-syntactic relationships between correlated elements. These features may be used in a flat formalization in a similar way as discourse prominence: Instead of requiring that the preverbal elements have a PROM + feature, the construction would require that the preverbal elements and the finite verb share the appropriate COLLOCATION features. While these features are compatible with my flat analysis, I remain agnostic about such an approach.

(273) SIMPLE-DISCOURSE-PROMINENCE CONSTRUCTION (\uparrow *linear-cxt*)

- a. $V' \rightarrow \langle X_1[\text{PROM } +], \dots, X_i[\text{PROM } +], V[\textit{fn}], X_{i+1}, \dots, X_n \rangle$
- b. A verbal structure may consist of a sequence of signs, where the finite verb appears after all prominent signs but before all non-prominent signs.

c.

$$\textit{simple-disc-prom-cxt} \Rightarrow \left[\begin{array}{l} \text{MTR} \quad \left[\text{SYN} \quad \left[\text{CAT} \quad Y \right] \right] \\ \text{DTRS} \quad \textit{list} \left(\left[\text{PROM } + \right] \right) \oplus \langle H \rangle \oplus \textit{list} \\ \text{HD-DTR} \quad H : \left[\begin{array}{l} \textit{word} \\ \text{SYN} \quad \left[\text{CAT} \quad Y : \left[\text{VF} \quad \textit{fn} \right] \right] \end{array} \right] \end{array} \right]$$

(274) $\textit{simple-disc-prom-main-decl-cl} \Rightarrow \textit{simple-disc-prom-cxt} \wedge \textit{single-pred-cxt} \wedge \textit{decl-cl}$

Such an idiomatic construction may also license the syntactic structure of the sentence in (275) where a verb particle and an anaphor appear before the finite verb. This is possible because this LINEAR CONSTRUCTION underspecifies the types of elements which may appear before the finite verb. As long as a PREDICATION CONSTRUCTION licenses the combination of the elements, that is, the verb and its arguments, the utterance is valid.

- (275) [Los] [damit] **geht** es schon am 15. April.
 PRT there.with go.3SG.PRS it already on.the 15th April
 ‘It gets started on April 15th.’ (Müller, 2005b, 14)

Thus, the definition of verb third naturally fits into a flat construction-based analysis and interacts with previously defined constructions to license full clauses. Furthermore, the clause construction in (274) naturally captures the fact that the first elements must be constituents from the local clause, that is, they may not be extracted from more deeply embedded clauses, as required by the SINGLE-PREDICATE CONSTRUCTION. For example, the sentence in (276), with an embedded subordinate clause, shows how a verb third word ordering may not be realized where one of the first elements has been extracted from the embedded clause. Namely, in the second variant in (276b), *einen Nobelpreis* ‘a Nobel prize’ from the subordinate clause has incorrectly been realized before the finite verb in a verb third word ordering. To account for such a restriction in an extraction-based

account, further constraints would need to be placed on extraction for the realization of such word orderings.

- (276) a. Ich **glaube** dem Linguisten nicht, [einen Nobelpreis gewonnen zu haben].
 I believe.1SG.PRS the.DAT linguist not a.ACC nobel.prize win.PST.PTCP to haben].
 have.INF
 ‘I don’t believe the linguist to have won a Nobel prize.’
- b. *[Dem Linguisten] [einen Nobelpreis] **glaube** ich nicht gewonnen zu haben. (Müller, 2005b, 8)

Even more elements are possible before the finite verb to produce verb fourth word order, as illustrated in §2.4. Although this ordering is not explicitly discussed here, it has the same characteristics as verb third word ordering and may be licensed by the same construction.

5.4.7 Content Questions

In addition to the declarative clauses described in the previous sections, content questions are also verb second in German with a *wh*-interrogative appearing canonically in the first position. For instance, consider the content questions in (277) which illustrate the verb second placement as well as the appearance of the *wh*-interrogative in the first position. This initial placement of the *wh*-interrogative is usually treated in the same way as such interrogatives in English, namely, the interrogative is licensed by the HEAD-FILLER CONSTRUCTION. However, as discussed in §3.7.1 there is no evidence that an extraction-based analysis is appropriate for a flexible word order language like German. So, I analyze the *wh*-interrogatives in (277) as in-situ interrogatives which appear in the first position.

- (277) a. Was **erzählt** er seiner Tochter?
 what tell.3SG.PRS he his.DAT daughter
 ‘What is he telling his daughter?’
- b. Wer **erzählt** seiner Tochter ein Märchen?
 Who tell.3SG.PRS his.DAT daughter a fairy.tale
 ‘Who is telling his daughter a fairy tale?’

Ginzburg and Sag (2000) provide an in-depth analysis of interrogatives in English, and I largely follow their work. They describe two main types of wh-interrogative clauses: those where the wh-interrogative is realized by extraction in the first position and those where the wh-interrogative is realized in-situ. Under the extraction-based analysis, the interrogative, such as *wer* ‘who’ shown in (278), has a WH feature which is non-empty. This WH feature is then used in combination with GAP to license the extraction.

$$(278) \left[\begin{array}{l} \text{word} \\ \text{FORM} \quad \langle \textit{wer} \rangle \\ \text{SYN} \quad \left[\text{WH} \quad \{ \pi_i \} \right] \\ \text{STORE} \quad \{ \pi_i \} \end{array} \right]$$

Furthermore, in this extraction-based analysis, the use of this WH attribute allows the percolation of wh-interrogative-specific information in pied piping constructions, particularly with genitive wh-interrogatives like *wessen* ‘whose’ as illustrated by the sentence in (279). By percolating the WH attribute in the complex phrase *mit wessen Geld* ‘with whose money’, it is ensured that despite any construction used for the licensing of this phrase, the final realized construction will contain the original WH value from the relativizer *wessen*. Thus, it is possible to locally check the phrase *mit wessen Geld* for relativizer properties. However, under Ginzburg and Sag’s in-situ analysis, the wh-interrogative has an empty WH as there need not be any interaction with extraction mechanisms and the location of the interrogative is unimportant.

- (279) [Mit wessen Geld] **können** denn die Banken so ungeheuerlich spekulieren?
 with whose money can.3PL EMPH the banks so egregiously speculate.INF
 ‘With whose money can the banks so egregiously speculate?’¹⁰

Utilizing Ginzburg and Sag’s analyses of both extracted and in-situ interrogatives, I can provide an analysis for German interrogatives. Although German clause initial wh-interrogatives do not need extraction to be licensed and so seem to not need a WH feature, it is necessary to specify that they do indeed appear as the first element in the clause. So, there must be a way to specify

¹⁰Example from www.nzz.ch, 1/17/2011 via wortschatz.uni-leipzig.de, translation added.

which element is the wh-interrogative. The WH provides a mechanism to identify the interrogative constituent, particularly in complex cases of pied piping. So, the WH feature is, in fact, utilized here in combination with an in-situ analysis. That is, the flexible word order properties of German allow the wh-interrogative to appear in the first position without any facilitating mechanisms like extraction, and the non-empty WH attribute allows the identification of the wh-interrogative and the stipulation that it appears in the clause initial position.

Thus, an in-situ first position wh-interrogative clause can be described by the WH-FIRST-CLAUSE CONSTRUCTION in (280). Here it is specified that a wh-interrogative appears as the first DAUGHTER of the clause followed by all other elements. So, by combining the WH-FIRST-CLAUSE CONSTRUCTION with the SIMPLE-V2 and SINGLE-PREDICATE CONSTRUCTIONS, a full *simple-main-wh-first clause* is licensed as formalized in (281).

(280) WH-FIRST-CLAUSE CONSTRUCTION ($\uparrow wh-cl$)

a. $V' \rightarrow \langle WH, X_1, \dots, X_n \rangle$

b. A verbal structure may consist of a sequence of signs, the first of which must be a wh-interrogative.

c.
$$wh1-cl \Rightarrow \left[\begin{array}{l} \text{MTR} \quad \left[\text{SYN} \quad \left[\text{WH} \quad \{\} \right] \right] \\ \text{DTRS} \quad \left\langle \left[\text{SYN} \quad \left[\text{WH} \quad \{\pi\} \right] \right] \right\rangle \oplus list \end{array} \right]$$

(281) *simple-main-wh1-cl* \Rightarrow *simple-v2-cxt* \wedge *single-pred-cxt* \wedge *wh1-cl*

In addition to clause initial placement, wh-interrogatives may also appear in other positions in a clause as illustrated in (282). This phenomenon is comparable to the in-situ use of wh-interrogatives in English, which require a special discourse context to license their appearance. That is, in these German sentences, the use of the non-clause-initial wh-interrogative in (282b) is only licensed by the preceding context.

(282) a. Die arme Frau. Jetzt **nehmen** sie ihr auch noch das Haus weg.
the poor woman now take.3PL they she.DAT also still the house away
'The poor woman. Now they're also taking her house away from her.'

- b. Mal langsam. Jetzt **nimmt** ihr WER das Haus weg?
 PRT slowly now take.3SG she.DAT who.NOM the house away
 ‘Slow down. WHO is taking her house away from her now?’ (Reis, 1992, 222)

It is often only the presence of such a context which distinguishes clause initial wh-interrogatives from all other local cases. Ginzburg and Sag (2000, 280) write of English that “[i]t is clear that out of the blue an in-situ wh-interrogative clause is typically infelicitous. That is, an in-situ wh-clause minimally carries a presupposition of a particular kind.” But they write further that “this presupposition is difficult to characterize precisely”. The in-situ case in English corresponds to the non-initial case of German.

So, although it is difficult to distinguish the exact pragmatic constraints between the clause initial and non-initial types of wh-interrogatives, I must minimally allow the syntax to license both word orders. Ginzburg and Sag (2000, 280) do offer a simple approximation of the pragmatic differences by suggesting that the non-clause initial wh-interrogatives must have a non-empty QUESTION UNDER DISCUSSION value. They define this QUD feature as stipulating the single question which an utterance is concerning. So, I use this feature to approximate the pragmatic differences of non-initial wh-interrogatives as illustrated in (283). Here, any number of wh-interrogatives may appear in any order in a clause as long as there is some QUD. Thus, the utterance in (282b) is licensed by the SIMPLE-MAIN-QUD-WH-CLAUSE CONSTRUCTION in (284).

(283) QUD-WH-CLAUSE CONSTRUCTION ($\uparrow wh-cl$)

- a. $V' \rightarrow \{WH_1, \dots, WH_i, X_1, \dots, X_n\}$
 b. A verbal structure may consist of a sequence of signs which contain any number of contextual wh-interrogatives.

c.

$$qud-wh-cl \Rightarrow \left[\begin{array}{l} \text{MTR} \left[\begin{array}{l} \text{SYN} \left[\text{WH} \ \{\} \right] \\ \text{CNTXT} \left[\text{MAX-QUD} \ \text{question} \right] \end{array} \right] \\ \text{DTRS} \ \text{nelist} \left(\left[\begin{array}{l} \text{SYN} \left[\text{WH} \ \{\pi\} \right] \end{array} \right] \right) \circ \text{list} \end{array} \right]$$

(284) $simple-main-qud-wh-cl \Rightarrow simple-v2-cxt \wedge single-pred-cxt \wedge qud-wh-cl$

Although local occurrences of *wh*-interrogatives in German are analyzed as in-situ, there are non-local cases when *wh*-interrogatives are, in fact, licensed with the GAP feature. I will discuss these cases in §5.7.

5.4.8 Coordination

Constituent coordination, such as that between two noun phrases, is more syntactically straightforward than non-constituent coordination. The former is easily handled by a flat analysis. For instance, in (285), two nominal arguments are conjoined. Likewise, two verbs are conjoined in (286).

(285) Sie **liest** [[ein Buch] und [ein Magazin]].
 she read.3SG a book and a magazine
 ‘She is reading a book and a magazine.’

(286) Sie [[**schreibt**] und [**liest**]] ein Buch.
 she write.3SG and read.3SG a book
 ‘She is writing and reading a book.’

Generally, in these examples, two similar constituents are combined to form a new single constituent of the same kind. This is illustrated by the sample COORDINATION CONSTRUCTION in (287) where any number of daughters with the same syntactic features (e.g. all are verbs or nouns) create a new element with the same features. Alternatively, coordination could be analyzed as a series of binary branching structures. Munn (1993), for instance, claims that binding phenomena, like those discussed in §5.1.1, are correctly predicted by binary branching structures and c-command. However, there is much empirical counter-evidence as noted by Gazdar et al. (1980) and Sag (2000), among others. Given the lack of evidence, a binary branching approach is rejected.

(287) COORDINATION CONSTRUCTION

$$X' \rightarrow \langle X, \dots, X, [conj], X \rangle$$

Non-constituent coordination, however, such as in the case of right node raising (RNR), sometimes referred to as Backward Periphery Ellipsis (Hartmann, 2000), is only exacerbated by flexible word order where the definition of ‘constituent’ becomes even more blurry. In fact, my analysis

eliminates much of the constituency which inherently exists in binary branching analyses. So, it is not immediately apparent how the coordinations illustrated in (288) are licensed under a flat analysis. These sentences provide examples of Backward Periphery Ellipsis like in (288d) as well as the opposite phenomenon in (288a), which could be viewed as Forward Periphery Ellipsis.

- (288) a. Ein Buch [[**kauft** der Mann] und [**liest** die Frau]].
 a book buy.3SG the.NOM man and read.3SG the woman
 ‘The man is buying and the woman is reading a book.’
- b. Er [[**trinkt** einen Kaffee] und [**liest** ein Buch]].
 he.NOM drink.3SG a.ACC coffee and read.3SG a book.
 ‘He is drinking a coffee and reading a book.’
- c. Sie [[**empfiehlt** dem Mann] und [**schenkt** der Frau]] ein Buch.
 she recommend.3SG the.DAT man and give.3SG the.DAT woman a book
 ‘She recommends the man and gives the woman a book.’
- d. [[Er **kauft**] und [sie **liest**]] ein Buch.
 he.NOM buy.3SG and she read.3SG a book
 ‘He is buying and she is reading a book.’
- e. [[Sie **empfiehlt** dem Mann] und [er **schenkt** der Frau]] ein Buch.
 she recommend.3SG the.DAT man and he.NOM give.3SG the.DAT woman a
 book
 ‘She recommends the man and he gives the woman a book.’
- f. Er **hat** [[einen Kaffee *getrunken*] und [ein Buch *gelesen*]].
 he.NOM have.3SG a.ACC coffee drink.PST.PTCP and a book read.PST.PTCP
 ‘He drank a coffee and read a book.’
- g. Er [[**muss** ein Buch *lesen*] und [**will** einen Kaffee *kaufen*]].
 he.NOM must.3SG a book read.INF and want.3SG a.ACC coffee buy.INF
 ‘He has to read a book and wants to buy a coffee.’

In each of these examples, the conjuncts do not form constituents in my flat analysis, so the construction in (287) cannot handle these cases without further extensions to the grammar. There are two possible approaches to non-constituent coordination that are compatible with my theory: One posits unsaturated phrases which may then be coordinated (e.g. Steedman, 1991, 1996), and

the other posits ellipsis constructions which elide phonologically similar elements (e.g. Blevins and Sag, 1996; Wilder, 1997; Hartmann, 2000). I discuss these accounts in the following sections.

5.4.8.1 Partially Saturated Phrases

In my flat analysis, the PREDICATE CONSTRUCTIONS require that a verbal predicate combine with all of its arguments at once, as shown in (289). This valence saturation may be relaxed by positing partially saturated variants of the existing PREDICATE CONSTRUCTIONS, such as in (290), which allows a verbal predicate to combine with any number of arguments but not all. The deletion operator ‘ \ominus ’ indicates that some elements are removed from a list.

(289) SATURATED-SINGLE-PREDICATE CONSTRUCTION

$$V'[\text{VAL } \langle \rangle] \rightarrow \left\{ V[\text{VAL } \langle X_1, \dots, X_n \rangle], X_1, \dots, X_n \right\}$$

(290) PARTIALLY-SATURATED-SINGLE-PREDICATE CONSTRUCTION

$$V'[\text{VAL } L \ominus \langle X_1, \dots, X_n \rangle] \rightarrow \left\{ V[\text{VAL } L], X_1, \dots, X_n \right\}$$

Consequently, these partially saturated constructions would then allow many different possible constituency structures of a single utterance as illustrated in (291), which may seem undesirable. In these examples, multiple applications of the PARTIALLY-SATURATED-SINGLE-PREDICATE CONSTRUCTION produce more deeply embedded structures.

- (291) a. Sie **empfiehlt** dem Mann ein Buch.
 b. Sie [**empfiehlt** dem Mann] ein Buch.
 c. [Sie [**empfiehlt** dem Mann]] ein Buch.
 d. Sie [**empfiehlt** dem Mann ein Buch].
 e. [Sie **empfiehlt**] dem Mann ein Buch.
 f. [[Sie **empfiehlt**] dem Mann] ein Buch.
 g. [Sie **empfiehlt** dem Mann] ein Buch.
 she recommend.3SG the.DAT man a book
 ‘She recommends the man a book.’

Such syntactic ambiguity also exists in Combinatory Categorical Grammar (CCG). While many possible constituent structures are syntactically possible for the same exact sentence with the same meaning, Steedman (1991, 2000) argues that there is, in fact, only one correct structure when incorporating intonational and information structure constraints. For instance, consider the answers to the questions in (292) and (293) presented by Steedman and Baldrige (2011).

(292) Q: I know who proved soundness. But who proved COMPLETENESS?

A: (MARCEL) (proved COMPLETENESS).

(293) Q: I know which result Marcel PREDICTED. But which result did Marcel PROVE?

A: (Marcel PROVED) (COMPLETENESS).

In these examples, the topic is set up by the question which then influences the prosodic phrasing of the answer. This phrasing is what then determines the correct syntactic constituency. So, while the syntax allows many possible constituent structures, the single correct structure can only be determined after considering further constraints from information structure and prosody. My flat analysis could adopt this CCG approach with partially saturated constructions to appropriately determine the correct constituent structure of an utterance. Thus, the syntax need only provide the possible structures, and further non-syntactic constraints license the most appropriate one. In usual circumstances, it is expected that constraints like prosodic phrasing would generally span an entire clause and thus license a flat structure, and only in certain contexts would there be embedded unsaturated phrases. Naturally, elements may not shuffle out of an embedded clause into a matrix clause.

5.4.8.2 Ellipsis

Alternatively, it is possible that apparent non-constituent coordination is an elliptical phenomenon, not requiring any revision to the constructions proposed above. In this approach, peripheral strings are deleted from the phonology of the mother node, as illustrated in (294) and (295). Thus, the syntax need only account for the coordination of fully saturated clauses, which is handled by a flat analysis.

- (294) Mary cooked a ~~pizza~~ and Bill ate a pizza. (Beavers and Sag, 2004)
- (295) Those who voted AGAINST ~~my father's motion~~ far outnumbered those who voted FOR my father's motion. (Huddleston et al., 2002, 1344)

Such ellipsis may similarly be applied to the German sentence in (288d) as shown in (296).

- (296) Er **kauft** ~~ein Buch~~ und sie **liest** ein Buch.
 he.NOM buy.3SG a book and she read.3SG a book
 'He is buying and she is reading a book.'

This type of analysis is motivated by evidence which shows that elided material need not be sensitive to syntactic structure. For instance, consider the sentences in (297) where non-constituents have been coordinated. In the first example, only part of a noun phrase and an infinitival phrase have been elided. And in the second example, a past participle and subordinated clause has been elided. Both groupings do not form syntactic constituents to be easily shared by the conjoined clauses. Furthermore, morphemes may be elided such as those in (298). Certainly no syntactic approach to coordination can account for these examples where the morphemes are directly coordinated.

- (297) a. Peter **verspricht** seiner ~~Mutter in die Kirche zu gehen~~ und Maria **verspricht**
 Peter promise.3SG his.DAT mother in the church to go.INF and Maria promise.3SG
 ihrer Mutter in die Kirche zu gehen.
 her.DAT mother in the church to go.INF
 'Peter promises his mother to go to church, and Maria promises her mother to go to church.'
- b. Ramona **hat** Peter ~~gefragt, wann der Nikolaus endlich kommt,~~ und
 Ramona have.3SG Peter ask.PST.PTCT when the Santa.Claus finally come.3SG and
 Ramona **hat** Martin gefragt, wann der Nikolaus endlich kommt.
 Ramona have.3SG Martin ask.PST.PTCT when the Santa.Claus finally come.3SG
 'Ramona asked Peter, and Romana asked Martin when Santa Clause will finally arrive.'
- (Hartmann, 2000, 57)

- (298) a. die Ober- und Teile der Mittel[schicht] (= *Oberschicht*)
 the upper and parts of.the lower.class
 ‘the upper and parts of the lower class’ (Clematide, 2009, 52)
- b. Umwandlung von Miet- in Eigentums[wohnungen] (= *Mietwohnungen*)
 conversion of rent into property.homes
 ‘conversion of rented apartments into condominiums’ (Clematide, 2009, 53)
- c. [Brutto]lohn- und -gehalts[summe] (= *Bruttolohnsumme und Bruttogehaltssumme*)
 gross.wage and salary.sum
 ‘gross wages and salary’ (Clematide, 2009, 39)
- d. die Sanierung von Hochbehältern, [Tief]brunnen, und -pumpen (= *Tiefpumpen*)
 the restoration of elevated.tanks, deep.wells and pumps
 ‘the restoration of elevated tanks, deep wells, and pumps’ (Clematide, 2009, 56)

Hartmann (2000) argues that sentences like (297) are instances of RNR, more specifically, of a PF-Reduction operation that deletes phonological elements, not syntactic structure. Hartmann provides evidence showing that coordination does not follow syntactic constituency or restrictions on movement and extraposition, deleted elements must not have semantic identity (e.g. the books in (296) must not be the same book), and scope relations are not altered by RNR. It is this type of ellipsis, Hartmann claims, that licenses all non-constituent coordination in German.¹¹

Cases like (299a), however, indicate that pure phonological deletion is not sufficient, contra Hartmann (2000, 79). Namely, the source for this elided phrase would necessarily be the sentence in (299b), which is ungrammatical. Instead, the sentence in (299c) provides the most plausible source. Chaves (2014) argues that this is a case of cumulation where an additional function allows contextual interpretation to alter the morpho-phonology.

¹¹While Hartmann (2000, 33) promotes an ellipsis approach to coordination, she claims that some cases of coordination appear not to be ellipsis as in *Jemand [[kam um vier Uhr] und [ging um fünf Uhr]]* ‘Someone [[came at four o’clock] and [went at five o’clock]]. That is, because it is the same *someone* who came at four and went at five, this must be a case of something like VP coordination as the brackets indicate. However, there is good reason to doubt that this type of construction involves a non-local dependency. I show in §3.6.3 that expletives may not appear non-locally. So, the phrase *Es regnet und schneit* ‘It rains and snows’ must not have an embedded structure because the expletive *es* must appear locally. That is, the phrase would be derived from *[Es regnet] und [es schneit]*. Thus, it appears that this type of coordination is in fact also ellipsis.

- (299) a. [Tom **schrie**] und [Mary **flüsterte**] den Namen des jeweils
Tom yell.3SG.PST and Mary whisper.3SG.PST the name of.the corresponding
anderen.
other
'Tom yelled and Mary whispered each other's name.'
- b. *[Tom **schrie** den Namen des jeweils anderen] und [Mary **flüsterte** den Namen des
jeweils anderen].
- c. [Tom **schrie** den Namen des anderen] und [Mary **flüsterte** den Namen des anderen].

Moreover, some examples of conjunction show that coordinated elements may not simply be phonologically identical but must be morphologically compatible. For instance, in (300) *bat* represents two different homophonous words and must simultaneously be an animal and sports instrument. In (301), the whole words, e.g. *butterfly* and *firefly*, have been grammaticalized, and there are no morphemes to delete.

(300) #Robin swung, and Leslie tamed, an unusual bat. (Levine and Hukari, 2006, 156)

- (301) a. *We caught butter- and fire[flies]. (Chaves, 2008)
- b. *We need black- and floor[boards]. (Artstein, 2005)

Drawing from Yatabe (2002), Beavers and Sag (2004), and Chaves (2008, 2014), the BACKWARD-DELETION CONSTRUCTION in (302) formalizes an ellipsis-based approach to coordination in SBCG. Here, the FORM feature reflects the morphological elements in a sign. This construction is a unary branching rule which takes a sign with repeated morphological elements, signified by the *F* indices, and subsequently omits the first grouping. This construction is illustrated in (303) for the sentence in (288d). So, given a fully licensed sentence with two coordinated clauses, this BACKWARD-DELETION CONSTRUCTION could be applied to delete repeated elements and license sentences such as those in (288).¹²

¹²See Chaves (2014) for more discussion about how the construction in (302) can be augmented to handle the sentence in (299a).

(302) BACKWARD-DELETION CONSTRUCTION

$$\left[\text{FORM } L_1 \oplus L_2 \oplus L_3 \oplus L_4 \right] \rightarrow \left[\text{FORM } L_1 \oplus \langle F_1, \dots, F_n \rangle \oplus L_2 \oplus L_3 : \langle F_1, \dots, F_n \rangle \oplus L_4 \right]$$

(303)

$$\boxed{\begin{array}{c} \left[\text{FORM } \langle er, kauft \rangle \oplus \langle und, sie, liest \rangle \oplus \langle ein, Buch \rangle \right] \\ | \\ \left[\text{FORM } \langle er, kauft \rangle \oplus \langle ein, Buch \rangle \oplus \langle und, sie, liest \rangle \oplus \langle ein, Buch \rangle \right] \end{array}}$$

Finally, partial verb phrases seem to provide evidence against an ellipsis analysis and in favor of a binary branching analysis. For instance, the sentence in (304a), repeated from (245), apparently contains an unsaturated verb phrase which appears before the finite verb *wird* ‘will’. As discussed in Chapter 3, the first position provides a traditional test to help determine constituency. Furthermore, the ability to coordinate such phrases, as illustrated in (304b), seemingly provides further evidence that partial verb phrases should be constituents.

- (304) a. [Ein Märchen ERZÄHLEN] **wird** er seiner Tochter.
 a fairy.tale tell.INF will.3SG.PRS he his.DAT daughter
 ‘He will TELL his daughter a fairy tale.’
- b. [[Ein Märchen ERZÄHLEN] und [ein Buch GEBEN]] **wird** er seiner
 a fairy.tale tell.INF and a book give.INF will.3SG.PRS he his.DAT
 Tochter.
 daughter
 ‘It is a fairy tale that he will TELL and a book that he will GIVE his daughter.’

However, it need not be the case that partial verb phrases are constituents. In §5.4.4.2, I have shown that it is advantageous not to posit an initial partial verb phrase constituent, as a flat structure naturally licenses subject agreement without any further mechanisms. Additionally, partial verb phrases are not pragmatically neutral and require some stress, as indicated by the capital letters in these examples. For instance, the sentences in (305) illustrate the type of context that a partial verb phrase utterance requires. Here, there is contrastive focus on the phrase *ein Märchen erzählen* ‘a fairy tale tell’. According to the theory in Hartmann (2000), this contrastive context is sufficient to trigger ellipsis. Indeed, such focus structure provides strong evidence for ellipsis.

- (305) Er **wird** kein Märchen für seine Tochter schreiben. Ein Märchen ERZÄHLEN
 He will.3SG no fairy.tail for his daughter write.INF a fairy.tale tell.INF
wird er seiner Tochter.
 will.3SG.PRS he his.DAT daughter
 ‘He won’t write a fairy tale for his daughter. He will TELL his daughter a fairy tale.’

Additionally, there is no evidence that partial verb phrase structures should be treated as a single constituent. In fact, Nerbonne (1994), like me, also assumes a flat structure of German clauses because of the potential spurious ambiguities that would occur in the Mittelfeld with partial verb phrases due to flexible word order. However, he does posit single partial verb phrase constituents when they are fronted like in (304a). This contradiction is only motivated by the need for first elements to be a filler in the extraction-based approach he adopts. Thus, this exception is made because of a theory-dependent restriction, and there remains no clear empirical evidence for partial verb phrase constituents. Furthermore, I have shown in Chapter 3, that extraction is not necessary and is, in fact, undesirable to account for first position elements. So, this removes any potential restriction that a first element must be a single constituent.

In all, because German shows ample evidence that coordination often does not respect syntactic constituency, an ellipsis approach is plausible. This ellipsis approach to coordination is compatible with flatter syntactic structure and does not require any additional constituency structure, such as partial verb phrases.

5.4.9 Summary

In this section, I have shown how flat, surface-oriented constructions can be used to accurately constrain all possible word orders of a main German clause with V2 or V2-like (as in the case of verb third) word ordering. These constructions correctly stipulate the location of the finite verb while also allowing for flexible word order. Figure 5.17 illustrates all of the flat constructions discussed in this section and show how they may be combined to license complete clauses. Here it can be seen how a small set of flat constructions are combined to appropriately constrain and license a large variety of word orderings. Furthermore, a flat construction-based analysis avoids many problems present in binary branching analyses by, for instance, correctly constraining subject

agreement in fronted partial verb phrases (cf. §5.4.4.2) and preventing unacceptable extraction in verb third clauses (cf. §5.4.6).

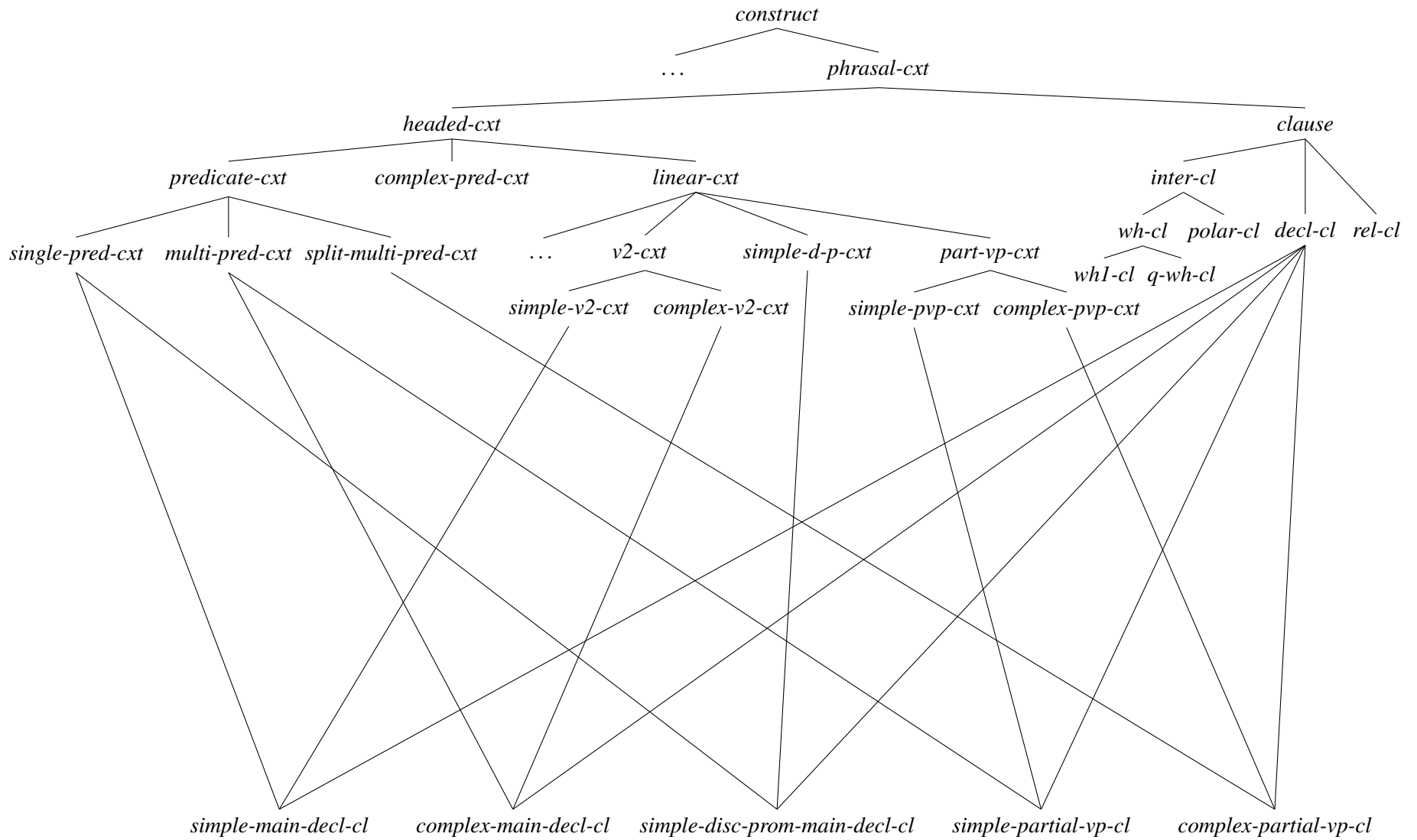

Figure 5.17: Type hierarchy of flat constructions used to license V2(-like) declarative clauses in German.

5.5 Other Linear Orders

While the discussion in this chapter is predominantly centered on word order in V2 clauses, the PREDICATE CONSTRUCTIONS described in the previous sections naturally lend themselves to licensing clauses with non-V2 word orders. Particularly, these constructions do not require any modification to license clauses with non-V2 word order. The only additional constructions which are required are those which constrain the placement of the finite verb in the initial or final position. In this section I introduce these LINEAR CONSTRUCTIONS to license the remaining finite verb placements. This then exhausts all possible single-clause word order configurations in German as described in Chapter 2.

5.5.1 Verb Initial

Polar question clauses are verb initial (V1) in German as illustrated in (306). Because this sentence contains a single predicate, it is licensed with the same SINGLE-PREDICATE CONSTRUCTION used with the V2 word orders. The PREDICATE CONSTRUCTIONS license the saturation of valence elements independent of the particular LINEAR CONSTRUCTION used.

- (306) a. **Erzählt** er seiner Tochter ein Märchen?
 tell.3SG.PRS he his.DAT daughter a fairy.tale
 ‘Is he telling his daughter a fairy tale?’

In (306), the finite verb appears in the first position of the clause and is followed by all remaining elements, which could appear in any order given the appropriate stress. The SIMPLE-V1 CONSTRUCTION in (307) formalizes this word order.

(307) SIMPLE-V1 CONSTRUCTION (\uparrow *linear-cxt*)

$$a. V' \rightarrow \langle V[fin], X_1, \dots, X_n \rangle$$

b. A verbal structure may consist of a sequence of signs, the first of which must be a finite verb.

$$c. \text{simple-v1-cxt} \Rightarrow \left[\begin{array}{l} \text{MTR} \quad \left[\text{SYN} \quad \left[\text{CAT} \quad Y \right] \right] \\ \text{DTRS} \quad \langle H \rangle \oplus list \\ \text{HD-DTR} \quad H : \left[\begin{array}{l} word \\ \text{SYN} \quad \left[\text{CAT} \quad Y : \left[\text{VF} \quad fin \right] \right] \end{array} \right] \end{array} \right]$$

Once again, following the sentence modes described by Kathol (2000) and as shown in the construction hierarchy in Figure 5.17, the POLAR-CLAUSE CONSTRUCTION is used to ensure that the appropriate polar question semantic and discourse properties are included, which are not discussed here. So, this verb initial clause with a single predicate is licensed by the SIMPLE-MAIN-POLAR-CLAUSE CONSTRUCTION in (308).

(308) *simple-main-polar-cl* \Rightarrow *simple-v1-cxt* \wedge *single-pred-cxt* \wedge *polar-cl*

Like V2 clauses, there may also be additional non-finite verbs at the end of a V1 clause, which are also licensed with the MULTI-PREDICATE and COMPLEX-PREDICATE CONSTRUCTIONS.

(309) a. **Wird** er seiner Tochter ein Märchen [erzählen müssen].
 will.3SG.PRS he his.DAT daughter a fairy.tale tell.INF must.INF
 ‘Will he have to tell his daughter a fairy tale?’

The COMPLEX-V1 CONSTRUCTION in (310) must be defined to license the particular verb configuration of V1 clauses with non-finite predicates. A COMPLEX-MAIN-POLAR CLAUSE is then licensed with the construction in (311).

(310) COMPLEX-V1 CONSTRUCTION (\uparrow *linear-cxt*)

$$a. V' \rightarrow \left\langle V \left[\begin{array}{l} \text{CAT} \quad [VF \quad fin] \\ \text{VAL} \quad \langle \dots, \boxed{1}, \dots \rangle \end{array} \right], X_1, \dots, X_i, \boxed{1}V[nfin], X_{i+1}[\text{EXTRA } +], \dots, X_n[\text{EXTRA } +] \right\rangle$$

- b. A verbal structure may consist of a sequence of signs which contains two verbal predicates, a finite one which subcategorizes for the other non-finite one. The finite verb must be the first sign, and the non-finite predicate follows all signs but precedes any extraposed signs.

$$c. \text{complex-v1-cxt} \Rightarrow \left[\begin{array}{l} \text{MTR} \quad \left[\begin{array}{l} \text{SYN} \quad [CAT \quad Y] \end{array} \right] \\ \text{DTRS} \quad \langle H \rangle \oplus list \oplus \left\langle Z : \left[\begin{array}{l} \text{SYN} \quad [CAT \quad [VF \quad nfin]] \end{array} \right] \right\rangle \oplus \\ list \left([EXTRA \ +] \right) \\ \text{HD-DTR} \quad H : \left[\begin{array}{l} word \\ \text{SYN} \quad \left[\begin{array}{l} \text{CAT} \quad Y : [VF \quad fin] \\ \text{VAL} \quad \langle Z \rangle \circ list \end{array} \right] \end{array} \right] \end{array} \right]$$

$$(311) \text{ complex-main-polar-cl} \Rightarrow \text{complex-v1-cxt} \wedge \text{multi-pred-cxt} \wedge \text{polar-cl}$$

5.5.2 Verb Final

In German, the finite verb appears at the end of any subordinate clause, like the example (312), which realizes the finite verb in the final positions thus forming a verb final (VF) clause. This is also the case when there are multiple predicates as with example (313). Because all of the predicates of a VF clause appear in a contiguous cluster, they may form a single constituent with the COMPLEX-PREDICATE CONSTRUCTION. In the case of (313), the finite verb combines with the non-finite verb. The COMPLEX-PREDICATE CONSTRUCTION, defined in (232), allows the combination of any verbal element which is a *word*, in this case the finite verb, with any type of *nfin* verbal element.

- (312) a. ..., *dass* er seiner Tochter ein Märchen **erzählt**.
 that he his.DAT daughter a fairy.tale tell.3SG.PRS
 ‘... , that he is telling his daughter a fairy tale.’

Generally, the verbs in the verbal cluster are ordered so that a predicate appears after the element it subcategorizes for. In (313), the verb *muss* subcategorizes for and appears after *erzählen*. The ordering of the predicates may deviate from this standard in special constructions as discussed and analyzed by Hinrichs and Nakazawa (1994). However, these special orderings do not change the structure of the verbal cluster, rather only affect how the elements may shuffle.

- (313) a. ..., *dass* er seiner Tochter ein Märchen [erzählen **muss**].
 that he his.DAT daughter a fairy.tale tell.INF must.3SG.PRS
 ‘... , that he has to tell his daughter a fairy tale.’

Because the multiple predicates in (313) may be treated as a single verbal element, just as with (312) which truly has only one predicate, there only needs to be a single VERB-FINAL CONSTRUCTION. This construction, defined in (314), covers the simple and complex cases needed for other LINEAR CONSTRUCTIONS.

(314) VF CONSTRUCTION (\uparrow *linear-cxt*)

a. $V' \rightarrow \langle X_1, \dots, X_n, V[fin] \rangle$

- b. A verbal structure may consist of a sequence of signs, the last of which must be a finite predicate.

c.
$$vf-cxt \Rightarrow \left[\begin{array}{l} \text{MTR} \quad \left[\text{SYN} \quad \left[\text{CAT} \quad Y \right] \right] \\ \text{DTRS} \quad \text{list} \oplus \langle H \rangle \\ \text{HD-DTR} \quad H : \left[\text{SYN} \quad \left[\text{CAT} \quad Y : \left[\text{VF} \quad fin \right] \right] \right] \end{array} \right]$$

So, both of the clauses in (312) and (313) are licensed with the SUBORDINATE-DECLARATIVE-CLAUSE CONSTRUCTION in (315). Relative clauses, which are also verb final, would be licensed with a variant of this construction which would use the relative clause sentence mode construction. Both complement and relative clauses are discussed in more detail in §5.6.

(315) *subord-decl-cl* \Rightarrow *vf-cxt* \wedge *single-pred-cxt* \wedge *decl-cl*

5.5.3 Summary

In the previous sections, additional LINEAR CONSTRUCTIONS were defined to handle the cases when the finite verb appear clause initial and final. Figure 5.18 shows these new constructions included into the type hierarchy of all LINEAR CONSTRUCTIONS. It is with these constructions that the linear order of German, a flexible word order language with fixed finite verb placement, is properly licensed.

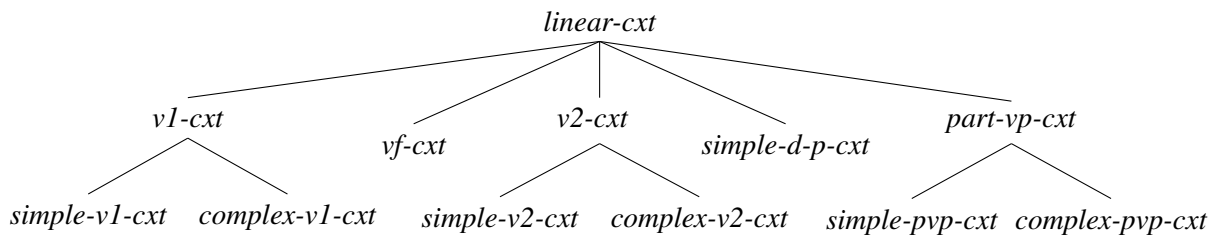

Figure 5.18: Full type hierarchy of LINEAR CONSTRUCTIONS.

5.6 Subordinate Clauses

The construction-based analysis of flexible word order described in this chapter advocates a much flatter representation of syntactic structure. However, there are cases in which embedded structures are necessary. In addition to the examples seen in previous sections, like complex predicates, other embedded structures are needed to license sentences with subordinate clauses.

Embedded subordinate clauses are handled by the flat construction-based approach formalized in this chapter, and a few examples of such complex sentences will be considered to illustrate this. In this section, I will consider three types of embedded clauses: complement, relative, and non-finite clauses.

5.6.1 Complement Clauses

Predicates may subcategorize for individual clauses, which are often introduced with a complementizer such as *dass* ‘that’. For instance, consider the sentence in (316). Here, a declarative V2 clause contains the predicate *wissen* ‘to know’, which subcategorizes for a subject and some complement clause, as shown in (317).

- (316) a. Sie **weiß**, [dass er seiner Tochter ein Märchen **erzählt**].
 she knows.3SG.PRS that he his.DAT daughter a fairy.tale tell.3SG.PRS
 ‘She knows, that he is telling his daughter a fairy tale.’

$$(317) \left[\begin{array}{l} \text{word} \\ \text{FORM} \langle \text{wissen} \rangle \\ \text{SYN} \left[\text{VAL} \langle \text{NP}, [\text{MRKG } \textit{that}] \rangle \right] \end{array} \right]$$

The complement clause in (316) has two main characteristics which are important to the analysis: The clause is introduced with the complementizer *dass* and the subordinate clause is verb final. It can be ensured that the complement clause begins with *dass* by appealing to the HEAD-FUNCTOR CONSTRUCTION in (318), repeated from (219), where some functor with a particular marking value selects for a complement structure. This structure then assumes the marking of the functor. A main use of this feature is to differentiate between various types of complement structures. The complementizer *dass* is such a functor that is utilized in the HEAD-FUNCTOR CONSTRUCTION. The lexical entry for *dass* in (319) shows that it has the MARKING value *that*. So, any complement structure combined with this functor will also have the resulting MARKING of *that*.

- (318) HEAD-FUNCTOR-CXT (\uparrow *headed-cxt*)

$$\textit{head-func-cxt} \Rightarrow \left[\begin{array}{l} \text{MTR} \left[\text{SYN } X \left[\text{MRKG } M \right] \right] \\ \text{DTRS} \left\langle \left[\text{SYN} \left[\text{CAT} \left[\text{SELECT } Y \right] \right] \right] \right\rangle, Y : \left[\text{SYN } X \right] \\ \text{HD-DTR } Y \end{array} \right]$$

$$(319) \left[\begin{array}{l} \text{word} \\ \text{FORM} \langle \textit{dass} \rangle \\ \text{SYN} \left[\begin{array}{l} \text{CAT } \textit{comp} \\ \text{MRKG } \textit{that} \end{array} \right] \end{array} \right]$$

At the main clause level it is easy to specify the position of the finite verb by the choice of LINEAR CONSTRUCTION. However, once a clause has been licensed, this linear order is not recorded

in the resulting feature structure. This includes subordinate clauses which are licensed in the same way and do not retain any information indicating their linear order. This poses a problem for complement clauses where the complementizer must select for a verb final structure. So, I posit a new LINEAR-MARKING feature which indicates the linear order of the finite verb with respect to the other elements. There are three possibilities as shown in Figure 5.19: one for each of the three types of linear order for clauses. This LINEAR-MARKING feature is similar to the MARKING feature introduced by Pollard and Sag (1994) and described within SBCG by Sag (2012, 86), where some functor may assign a MARKING value to a sign. Similarly, in my analysis, a linear construction assigns a LINEAR MARKING value.

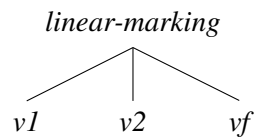

Figure 5.19: Type hierarchy of linear markings.

As shown in Figure 5.18, all of the verb initial and verb second constructions are types of V1 or V2 CONSTRUCTIONS. Accordingly these constructions must be minimally revised to include information about this new LIN-MRKG feature as seen below in (320) and (321). As a consequence of the type hierarchy, these LIN-MRKG specifications are inherited by the more specific constructions in the hierarchy, as intended. The VF CONSTRUCTION is also modified in (322) to include its appropriate LIN-MRKG value.

(320) V1 CONSTRUCTION (\uparrow *linear-cxt*)

$$v1-cxt \Rightarrow \left[\text{MTR} \left[\text{SYN} \left[\text{LIN-MRKG} \quad v1 \right] \right] \right]$$

(321) V2 CONSTRUCTION (\uparrow *linear-cxt*)

$$v2-cxt \Rightarrow \left[\text{MTR} \left[\text{SYN} \left[\text{LIN-MRKG} \quad v2 \right] \right] \right]$$

(322) VF CONSTRUCTION (\uparrow *linear-cxt*) (modified)

$$vf-cxt \Rightarrow \left[\begin{array}{l} \text{MTR} \quad \left[\text{SYN} \quad \left[\text{CAT} \quad Y \right] \right. \\ \left. \text{LIN-MRKG} \quad vf \right] \\ \text{DTRS} \quad list \oplus \langle H \rangle \\ \text{HD-DTR} \quad H : \left[\text{SYN} \quad \left[\text{CAT} \quad Y : \left[\text{VF} \quad fin \right] \right] \right] \end{array} \right]$$

By use of the LIN-MRKG feature, information about the linear position of the finite verb in a clause can be accessed outside of the clause, in very much the same way that the part of speech of a complex phrase is specified by the lexical head therein and can be accessed from outside that phrase.

Now it is possible for a matrix clause to select for a clause with a *vf* linear marking, thus ensuring that a complement clause is verb final. The COMPLEMENTIZER CONSTRUCTION in (323) formalizes this constraint by specifying that the functor must be a *complementizer*, and that the complement has a LINEAR MARKING value of *vf*. This construction ensures that all complementizer clauses consist of a complementizer followed by a saturated verb final clause. A full complementizer clause is thus defined in (324) as the combination of the COMPLEMENTIZER CONSTRUCTION, the HEAD-FUNCTOR CONSTRUCTION, which ensures that the complementizer marks the complement with *that*, and declarative clause features.

(323) COMPLEMENTIZER-CXT (\uparrow *headed-cxt*)

$$a. \quad V' \rightarrow \left\langle \text{COMP}, V \left[\begin{array}{l} \text{LIN-MRKG} \quad vf \\ \text{VAL} \quad \langle \rangle \end{array} \right] \right\rangle$$

b. A verbal structure may consist of a complementizer which precedes a saturated verb final clause.

$$c. \quad complementizer-cxt \Rightarrow \left[\begin{array}{l} \text{DTRS} \quad \left\langle \left[\text{SYN} \quad \left[\text{CAT} \quad [comp] \right] \right], H \right\rangle \\ \text{HD-DTR} \quad H : \left[\text{SYN} \quad \left[\text{CAT} \quad \left[\text{VF} \quad fin \right] \right] \right. \\ \left. \text{LIN-MRKG} \quad vf \right. \\ \left. \text{VAL} \quad \langle \rangle \right] \end{array} \right]$$

(324) *complementizer-cl* \Rightarrow *complementizer-cxt* \wedge *head-func-cxt* \wedge *decl-cl*

The main V2 clause in (316) is then licensed by the SIMPLE-MAIN-DECLARATIVE-CLAUSE CONSTRUCTION in (226) where the predicate subcategorizes for an argument with a marking value of *that*, which is licensed by the use of the complementizer *dass* and the COMPLEMENTIZER-CLAUSE CONSTRUCTION. Finally, the predicate *wissen* has two complements, the subject and the complement clause, which may shuffle in the main V2 clause. This whole sentence is depicted in (325). Here the FORM values are provided in the angle brackets to identify each element.

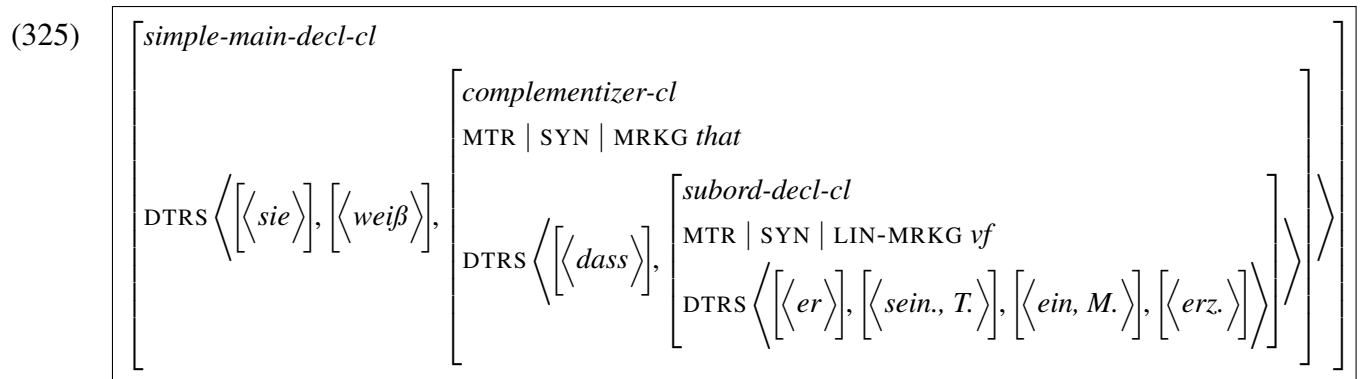

In addition to the word order shown in (316), the sentence may also be realized with the word order in (326) where the complement clause is in the first position. Because this subordinate clause is a single element, it may shuffle to the first position of the daughters list in the SIMPLE-MAIN-DECLARATIVE-CLAUSE CONSTRUCTION. Thus, the appropriate flexible word order properties of this complex clause naturally result from the flat constructions described in this chapter with minimal use of embedded structures.

- (326) a. [Dass er seiner Tochter ein Märchen erzählt], **weiß** sie.
 that he his.DAT daughter a fairy.tale tell.3SG.PRS knows.3SG.PRS she
 ‘That he is telling his daughter a fairy tale, she knows.’

5.6.2 Relative Clauses

As with *wh*-interrogatives discussed in §5.4.7, relative clauses do not require extraction to realize the relativizer in the required first position. For instance, consider the clause in (327) which contains the relative pronoun *der* ‘who’ in the first position of the subordinate clause. Such a relativizer must always appear in the first position and is often analyzed as an extracted element. But, although relative clauses are verb final and not verb second like content questions, the same

arguments against extraction apply here: Because flexible word order already allows any argument to appear in the first position, there is no need for extraction to aid in this alternate positioning of the relativizer.

- (327) a. der Mann, [der seiner Tochter ein Märchen **erzählt**].
 the man who.NOM his.DAT daughter a fairy.tale tell.3SG.PRS
 ‘the man, who is telling his daughter a fairy tale.’

The analysis for relative clauses is very similar to the analysis for content questions in §5.4.7, where the relative pronoun *der* has the lexical entry shown in (328). Like my analysis of wh-interrogatives with the WH feature, relative pronouns make use of the REL attribute in order to reliably determine which constituent is the relativizer by the percolation of this feature in a phrase. Furthermore, the REL feature is not used with extraction in my analysis, as it usually is in other analyses.

- (328)
$$\left[\begin{array}{l} \text{word} \\ \text{FORM} \langle \text{der} \rangle \\ \text{SYN} \left[\begin{array}{l} \text{CAT} \left[\begin{array}{l} \text{NUM} \text{ sg} \\ \text{GEN} \text{ masc} \\ \text{CASE} \text{ nom} \end{array} \right] \\ \text{REL} \langle \text{I} \rangle \end{array} \right] \end{array} \right]$$

Thus, using the REL feature, the RELATIVE-CLAUSE CONSTRUCTION in (329) correctly licenses the appropriate word order of a relative clause.¹³ In combination with the VERB-FINAL and SINGLE-PREDICATE CONSTRUCTIONS a full RELATIVE-DECLARATIVE-CLAUSE CONSTRUCTION, as formalized in (330), licenses the subordinate clause in (327).

¹³Although the relativizer directly combines with all of the clausal elements in a flat structure, it is still possible to coordinate two relative clauses in a structure like $\langle \text{REL}, X_1, \dots, X_n, \text{CONJ}, Y_1, \dots, Y_n \rangle$. This is licensed by an ellipsis approach to coordination as described in §5.4.8.2.

(329) RELATIVE-CLAUSE CONSTRUCTION ($\uparrow clause$)a. $V' \rightarrow \langle \text{REL}, X_1, \dots, X_n \rangle$

b. A verbal structure may consist of a sequence of signs, the first of which must be a relativizer.

c.
$$rel-cl \Rightarrow \left[\begin{array}{l} \text{MTR} \left[\text{SYN} \left[\text{REL} \ \{\} \right] \right] \\ \text{DTRS} \left\langle \left[\text{SYN} \left[\text{REL} \ \{\pi\} \right] \right] \right\rangle \oplus list \end{array} \right]$$
(330) $rel-decl-cl \Rightarrow vf-cxt \wedge single-pred-cxt \wedge rel-cl$

The RELATIVE-DECLARATIVE-CLAUSE CONSTRUCTION even handles complex cases like the one exemplified by (331). Here an embedded PP which modifies *ein Bild* ‘a picture’ appears separate from the NP in the first position. Such an example with a discontinuous NP is often used as an argument for the use of extraction: It is claimed that there is no way for the embedded PP to independently scramble to the first position.

(331) der Mann, [von dessen Schwester]_i Maria ein Bild _{-i} gemalt **hat**.
 the man of who.GEN sister Maria a picture paint.PST.PTCP have.3SG
 ‘the man, whose sister Maria painted a picture of.’ (Müller, 2007, 188)

However, as discussed in §3.7.2, De Kuthy (2002) argues that extraction, in fact, does not handle all cases of discontinuous NPs. Instead she provides a new analysis of such phenomena which is similar to the argument composition analysis of complex predicates. Consider the analysis of the discontinuous NP under question in (332). Here, the PP is an argument of the NP, and both form a single constituent. A verb then subcategorizes for this entire complex noun phrase. So, it would seem that extraction is required to realize the PP outside of this phrase.

(332)
$$\left[\begin{array}{l} hd-comp-cxt \\ \text{DTRS} \left\langle \left[\text{FORM} \ \langle ein, Bild \rangle \right] \right. \\ \left. \left[\text{SYN} \ \left[\text{VAL} \ \langle \mathbb{I} \rangle \right] \right] \right\rangle, \mathbb{I} \left[\text{FORM} \ \langle von, dessen, Schwester \rangle \right] \end{array} \right]$$

Yet, De Kuthy (2002, §4.3) shows that this complex noun phrase can be reanalyzed so that the arguments of the NP are raised to the verb which subcategorizes for it. In this case, the NP and PP do not combine to form a single phrase, and the verb subcategorizes for both the NP and PP. This then allows the NP and PP to be realized discontinuous from each other, thus allowing the PP to appear in the first position. This reanalysis approach is illustrated in (333) and shows that flat constructions easily license such a complex case.

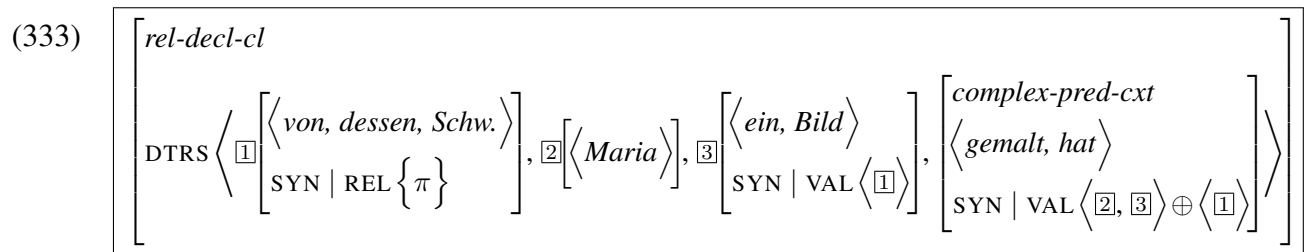

5.6.3 Non-finite Clauses

In §5.4.2, the COMPLEX-PREDICATE CONSTRUCTION was introduced to allow the arguments of two predicates to be combined in so-called *coherent* verbal constructions. All single clauses with multiple predicates discussed to this point have been coherent constructions. For instance, the sentence in (334a) reflects a coherent structure where the non-finite verbs have formed a complex predicate. As such, the subordinate clause cannot be extraposed because it does not form a single constituent as illustrated in (334b).

(334) Coherent Construction

- a. Peter **wird** das Fahrrad [reparieren müssen].
 Peter will.3SG the bicycle repair.INF must.INF
 ‘Peter will have to repair the bicycle.’
- b. *Peter **wird** müssen, das Fahrrad reparieren.

However, certain predicates do not allow argument composition and consequently do not license complex predicates. These structures are considered *incoherent* (Kiss, 1994; Hinrichs and Nakazawa, 1998; Müller, 2004, inter alia). Consider the example in (335a) where the verb *überreden* ‘to persuade’ subcategorizes for another verb phrase but cannot combine with the predicate *reparieren* ‘to repair’. This means that the subordinate clause *das Fahrrad zu reparieren* ‘to repair

the bicycle’ remains a single constituent. As shown in (335b), the embedded argument *das Fahrrad* cannot shuffle with *Maria* or *Peter*. Unlike *coherent* constructions, the subcategorized verb phrase may be extraposed as in (335c), where both the extraposed and non-extraposed versions of this sentence have the exact same meaning.

(335) Incoherent Construction

- a. Peter **muss** Maria [das Fahrrad zu reparieren] überreden.
 Peter must.3SG Maria the bicycle to repair.INF persuade.INF
 ‘Peter must persuade Maria to repair the bicycle.’
- b. *Peter **muss** das Fahrrad Maria zu reparieren überreden.
- c. Peter **muss** Maria überreden, das Fahrrad zu reparieren.

The verb *überreden* subcategorizes for an embedded phrase, like with the complement clause described in §5.6.1. However, the examples in (335) are different because the predicate *überreden* specifically subcategorizes for an infinitival phrase in a subject control structure as shown in (336). This means that the embedded clause is not completely saturated.

$$(336) \left[\begin{array}{l} \text{word} \\ \text{FORM} \langle \textit{überreden} \rangle \\ \text{SYN} \left[\text{VAL} \langle \text{NP}_x, \text{NP}_y, \left[\text{SYN} \left[\begin{array}{l} \text{MRKG} \textit{inf} \\ \text{VAL} \langle \text{NP}_y \rangle \end{array} \right] \rangle \right] \right] \end{array} \right]$$

Furthermore, the embedded infinitival clause partially saturates elements on a non-finite verb. The PREDICATE CONSTRUCTIONS discussed up to this point have only saturated arguments on finite verbs. Thus, the NON-FINITE-PREDICATE CONSTRUCTION in (337) combines an infinitival predicate with all of its arguments except the subject. This construction additionally ensures that the non-finite verb is in the final position.

(337) NON-FINITE-PREDICATE CONSTRUCTION (\uparrow head-comp-cxt)

$$a. \quad V' \left[\text{VAL} \langle X_1 \rangle \right] \rightarrow \left\langle X_2, \dots, X_n, V \left[\begin{array}{l} \text{MRKG} \quad \textit{inf} \\ \text{VAL} \quad \langle X_1, X_2, \dots, X_n \rangle \end{array} \right] \right\rangle$$

- b. A verbal structure may consist of a sequence of signs, which contains a single non-finite, infinitival predicate that combines with all of its arguments except the subject. The non-finite verb appears in the final position.

$$c. \quad \textit{non-fin-pred-cxt} \Rightarrow \left[\begin{array}{l} \text{MTR} \quad \left[\text{SYN} \quad \left[\begin{array}{l} \text{CAT} \quad Y \\ \text{VAL} \quad \langle X \rangle \end{array} \right] \right] \\ \text{DTRS} \quad L \oplus \langle H \rangle \\ \text{HD-DTR} \quad H : \left[\text{SYN} \quad \left[\begin{array}{l} \text{CAT} \quad Y : [\text{VF} \quad \textit{nfin}] \\ \text{MRKG} \quad \textit{inf} \\ \text{VAL} \quad \langle X \rangle \oplus L \end{array} \right] \right] \end{array} \right]$$

All verbs have a particular V(ERB)FORM as first discussed in §5.4.2 which has one of the values shown in the hierarchy repeated in Figure 5.20. Generally, most of the verbs discussed in this chapter have been finite verbs with the verb form *fin*. However, all verbs are lexically defined with *base* forms. Lexical constructions may change this verb form such as inflectional constructions which license *fin* verbs.

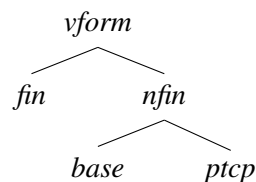

Figure 5.20: Type hierarchy of verb forms.

The verb *reparieren* ‘repair’, appearing in the incoherent construction in (335a), is uninflected and has a *base* verb form as illustrated in (338). The particle *zu* ‘to’ in (339) selects for a *base* verb and combines with it via the HEAD-FUNCTOR CONSTRUCTION in (318) to form the infinitival verbal structure *zu reparieren* ‘to repair’ with a MARKING value of *inf*.

$$(338) \left[\begin{array}{l} \text{word} \\ \text{FORM} \langle \textit{reparieren} \rangle \\ \text{SYN} \left[\begin{array}{l} \text{CAT} \left[\text{VF } \textit{base} \right] \\ \text{VAL} \langle \text{NP}_x, \text{NP}_y \rangle \end{array} \right] \end{array} \right]$$

$$(339) \left[\begin{array}{l} \text{word} \\ \text{FORM} \langle \textit{zu} \rangle \\ \text{SYN} \left[\begin{array}{l} \text{CAT} \left[\text{SELECT} \left[\text{SYN} \left[\text{CAT} \left[\text{VF } \textit{base} \right] \right] \right] \right] \right] \\ \text{MRKG } \textit{inf} \end{array} \right] \end{array} \right]$$

This *inf*-marked predicate then combines with all of its arguments except the subject to form an infinitival clause, as formally defined in (340) by the INFINITIVAL-CLAUSE CONSTRUCTION.

$$(340) \textit{inf-cl} \Rightarrow \textit{non-fin-pred-cxt} \wedge \textit{decl-cl}$$

Given this licensed infinitival clause, the main clause with the predicates *muss* and *überreden* is licensed with the SATURATED-MULTI-PREDICATE and COMPLEX-V2 CONSTRUCTIONS where the infinitival clause is one of the arguments of the predicate *überreden*. The full structure of this sentence is illustrated in (341) and shows the relatively flat structure for this complex sentence. Additionally, the COMPLEX-V2 CONSTRUCTION allows any arguments to be extraposed thus licensing the variant in (335c) where the infinitival complement appears after the final verbal complex of the main clause.

$$(341) \left[\begin{array}{l} \textit{complex-main-decl-cl} \\ \text{DTRS} \left\langle \left[\langle \textit{P.} \rangle \right], \left[\langle \textit{muss} \rangle \right], \left[\langle \textit{M.} \rangle \right], \left[\textit{inf-cl} \right], \left[\text{DTRS} \left\langle \left[\langle \textit{das, Fahr.} \rangle \right], \left[\begin{array}{l} \textit{head-func-cxt} \\ \text{MTR} \mid \text{SYN} \mid \text{MRKG } \textit{inf} \\ \text{DTRS} \left\langle \left[\langle \textit{zu} \rangle \right], \left[\langle \textit{rep.} \rangle \right] \right\rangle \right] \right\rangle, \left[\langle \textit{überra.} \rangle \right] \right\rangle \end{array} \right]$$

The discussion here has shown how the word order of *incoherent* structures are handled under a flat construction-based analysis. However, I do not address how a predicate stipulates if it partic-

ipates in a *coherent* or *incoherent* construction. Other analyses, such as the one described by Kiss (1994), do account for this additional information and are compatible with the analysis here.

5.7 Extraction

The construction-based analysis of German presented in this chapter uses flatter structures without extraction to license all local clause types. However, there are legitimate instances when extraction is necessary, namely, whenever an argument appears *non-locally*, i.e. in a different clause than its canonical location. Consider the sentence in (342) where the argument *um zwei Millionen Mark* ‘of two million marks’ from the embedded infinitival clause has been realized externally in the first position of the matrix V2 clause.

- (342) [Um zwei Millionen Mark]_i **soll** er versucht haben, [eine
of two million mark should.3SG.PRS he try.PST.PTCP have.INF a
Versicherung _{-i} zu betrügen].
insurance to defraud.INF
‘Of two million marks, he is trying to defraud an insurance company.’ (Müller, 2005a)

Such cases provide a motivation for the use of extraction to account for the first element in other analyses as discussed in §3.4. That is, because the first element of a V2 clause can be realized from any arbitrarily embedded clause, extraction should be used in all cases of the realization of the first element (cf. Müller, 2007, 165). However, this need not be the case. Rather, there only needs to be a mechanism which raises an argument to a higher clause in appropriately licensed non-local contexts.

I have shown in the previous sections that local first position elements are preferably licensed with flat structures and not some extraction operation. The syntax simply allows the arguments to shuffle in this flat structure while information structure constraints determine the ultimately realized first element. This is supported by the evidence in (343) repeated from §3.6.3. Here, the expletive *es* does not appear in the first position in (343a) due to an extraction mechanism, because *es* may not be extracted as shown in (343c). However, other elements which appear non-locally as in (343b) are indeed extracted, like in (342) above.

- (343) a. Es regnet in der Stadt.
EXPL rain.3SG.PRS in the city
'It is raining in the city.'
- b. [In der Stadt]_i sagt er, dass es _{-i} regnet.
in the city say.3SG.PRS he COMP EXPL rain.3SG.PRS
'In the city, he said, that it's raining.'
- c. *Es_i sagt er, dass _{-i} in der Stadt regnet.

Like local first position elements, extracted elements from an embedded clause should also be licensed with a flat structure. This enables an extracted element to shuffle in the matrix clause. For instance, consider the example in (344a) where *über das Thema* 'on the topic' has been extracted from the embedded infinitival clause to the first position of the matrix clause. But this extracted element need not be the first element. Instead it may shuffle with the arguments of the matrix clause as shown in (344b) and (344c). Naturally this shuffling is constrained by non-syntactic discourse constraints. Other approaches to V2 word order which utilize an extraction mechanism cannot account for the phenomenon in (344b) and (344c) because the FILLER-HEAD CONSTRUCTION requires that the filler be the first element.

- (344) a. [Über das Thema]_i **hat** er Peter gebeten, [einen Vortrag _{-i} zu halten]
about the topic have.3SG he Peter ask.PST.PTCP a.ACC presentation to
halten]
hold.INF
'He asked Peter to give a presentation on the topic.'
- b. Er **hat** Peter [über das Thema]_i gebeten, [einen Vortrag _{-i} zu halten]
- c. Er **hat** [über das Thema]_i Peter gebeten, [einen Vortrag _{-i} zu halten]

To formally illustrate this extraction process in my flat analysis, I return to the original example in (342) where *um zwei Millionen Mark* 'of two million marks' appears in the first position. First, the verb *betrügen* 'to defraud' is defined in (345). Here, the verb subcategorizes for the subject and direct object, but also a PP which begins with the preposition *um*.

$$(345) \left[\begin{array}{l} \text{word} \\ \text{FORM} \langle \text{betrügen} \rangle \\ \text{VAL} \langle \text{NP, NP, PP}[\text{um}] \rangle \end{array} \right]$$

Using the GAP feature from standard SBCG extraction analyses (cf. Sag, 2010), this PP argument of *betrügen* may appear on the GAP list of a predicate instead of being realized locally. This GAP value is then percolated up to the MOTHER of the *infinitival-clause* as illustrated in (346).

$$(346) \left[\begin{array}{l} \text{inf-cl} \\ \text{MTR} \left[\text{SYN} \left[\text{GAP} \langle \text{PP}[\text{um}] \rangle \right] \right] \\ \text{DTRS} \left\langle \left[\langle \text{eine, Versicherung} \rangle \right], \left[\begin{array}{l} \text{head-func-cxt} \\ \text{DTRS} \left\langle \left[\langle \text{zu} \rangle \right], \left[\langle \text{betrügen} \rangle \right] \right] \right] \right\rangle \end{array} \right]$$

Next, the matrix clause in (342) would be licensed by the COMPLEX-MAIN-DECLARATIVE-CLAUSE CONSTRUCTION as described in §5.4.2, if there were no extracted element. However, the extracted PP must also be accounted for in this instance. So, an alternative to the COMPLEX-MAIN-DECLARATIVE-CLAUSE CONSTRUCTION must be defined to allow elements from the GAP list of embedded clause arguments to appear locally. This also requires a new variant of the MULTI-PREDICATE CONSTRUCTION, one of the component constructions of the clause, namely the new FILLER-MULTI-PREDICATE CONSTRUCTION shown in (347) which allows the realization of a filler on its DAUGHTERS list. Because this filler is shuffled with the other daughters of the matrix clause, the filler need not be the first element as in (344b). The constraint that the gap comes from an embedded clause explicitly formalizes the assertion that extraction is only used to license non-local phenomena.

(347) FILLER-MULTI-PREDICATE CONSTRUCTION (\uparrow *predicate-cxt*)

$$a. \quad V, \begin{bmatrix} \text{VAL} & \langle \rangle \\ \text{GAP} & \langle \rangle \end{bmatrix} \rightarrow \left\{ V \begin{bmatrix} \text{VAL} & \langle X_1, \mathbb{1} \rangle \\ \text{GAP} & \langle \rangle \end{bmatrix}, X_1, \dots, X_n, F, \mathbb{2}V, \right. \\ \left. \mathbb{1}V \begin{bmatrix} \text{VAL} & \langle X_1, \dots, X_n, \mathbb{2}V \begin{bmatrix} \text{VAL} & \langle \rangle \\ \text{GAP} & \langle F \rangle \end{bmatrix} \rangle \rangle \right\}$$

- b. A verbal structure may consist of a sequence of signs which contains two verbal predicates and a subordinate clause which has a gapped sign. One predicate subcategorizes for the other predicate which subcategorizes for the subordinate clause. The remaining signs consist of the arguments of the second predicate and the gapped sign. The predicates share the same subject. All of the signs may appear in any order.

$$c. \quad \begin{array}{l} \text{MTR} \\ \text{DTRS} \\ \text{HD-DTR} \end{array} \left[\begin{array}{l} \begin{array}{l} \text{SYN} \\ \text{CAT} \\ \text{VAL} \\ \text{GAP} \end{array} \begin{array}{l} Y \\ \langle \rangle \\ \langle \rangle \end{array} \\ \langle H \rangle \circ \langle X \rangle \circ L_1 \circ \langle F \rangle \circ \langle C \rangle \circ \\ \left\langle Z : \begin{array}{l} \text{SYN} \\ \text{CAT} \\ \text{VAL} \\ \text{GAP} \end{array} \begin{array}{l} [VF \quad nfn] \\ \langle X \rangle \oplus L_1 \oplus \\ \langle clause \\ \text{SYN} \quad [GAP \quad \langle F \rangle] \rangle \rangle \right\rangle \\ \begin{array}{l} \text{word} \\ \text{SYN} \\ \text{CAT} \\ \text{VAL} \end{array} \begin{array}{l} Y : [VF \quad fn] \\ \langle X, Z \rangle \end{array} \end{array} \right]$$

Incorporating this FILLER-MULTI-PREDICATE CONSTRUCTION into the new COMPLEX-FILLER-MAIN-DECLARATIVE-CLAUSE CONSTRUCTION, shown in (348), the matrix clause of the sentence in (342) may be licensed.

$$(348) \quad \text{complex-filler-main-declarative-cl} \Rightarrow \text{complex-v2-cxt} \wedge \text{filler-multi-pred-cxt} \wedge \text{decl-cl}$$

Thus, as depicted in (349), the full sentence is licensed by this new FILLER CONSTRUCTION. The extraposed embedded clause has a single element on its GAP list. The complex predicate in

the matrix clause subcategorizes for the embedded clause, so the gap element may be realized locally in the matrix clause. The gap element is then removed from the GAP list. The constructions defined here do not ensure that the extracted element appears as the first element, but this sort of topicalization is motivated by discourse and pragmatic factors which do constrain such elements to the first position.

- (349)
$$\left[\begin{array}{l} \text{complex-filler-main-declarative-cl} \\ \text{MTR} \mid \text{SYN} \mid \text{GAP} \langle \rangle \\ \\ \text{DTRS} \langle \text{[1]} \langle \text{um, z., Mil., M.} \rangle \rangle, \left[\begin{array}{l} \langle \text{soll} \rangle \\ \text{SYN} \mid \text{VAL} \langle \text{[2], [3]} \rangle \end{array} \right], \text{[2]} \langle \text{er} \rangle, \text{[3]} \left[\begin{array}{l} \text{complex-pred-cxt} \\ \langle \text{versucht, haben} \rangle \\ \text{SYN} \mid \text{VAL} \langle \text{[2], [4]} \rangle \end{array} \right], \text{[4]} \left[\begin{array}{l} \text{inf-cl} \\ \langle \text{eine, V., zu, betr.} \rangle \\ \text{SYN} \left[\begin{array}{l} \text{EXTRA} + \\ \text{GAP} \langle \text{[1]} \rangle \end{array} \right] \end{array} \right] \rangle \end{array} \right]$$

In a similar manner, the extraction of the PP to the first position of the clause in (350), the relative clause variant of (344a), is also licensed with a modification to a PREDICATE CONSTRUCTION. Unlike the previous example, this sentence has an embedded clause with a discontinuous noun phrase, as described in §3.7.2 and §5.6.2, where the PP of this discontinuous phrase has been extracted to the matrix clause.

- (350) das Thema, [über das]_i er Peter gebeten hat, [einen Vortrag _{-i} zu
 the topic about which he Peter ask.PST.PTCP have.3SG a.ACC presentation to
 halten]
 hold.INF
 ‘the topic, which he asked Peter to give a presentation on’ (Müller, 2007)

First, the noun phrase *einen Vortrag über das* ‘a presentation about which’ is reanalyzed following the constructions described by De Kuthy (2002) so that the sub-PP is added as an argument to the noun phrase’s predicate and both sub-parts may be realized separately. This sub-PP can then become a gap element not to be realized locally as illustrated by the construction in (351) depicting the structure of the embedded infinitival clause.

$$(351) \left[\begin{array}{l} \text{inf-cl} \\ \text{MTR} \left[\text{SYN} \mid \text{GAP} \left\langle \boxed{1} [\text{SYN } \textit{prep}] \right\rangle \right] \\ \text{DTRS} \left\langle \left[\begin{array}{l} \langle \textit{einen, Vortrag} \rangle \\ \text{SYN} \left[\begin{array}{l} \textit{noun} \\ \text{VAL} \langle \boxed{1} \rangle \end{array} \right] \end{array} \right], \left[\begin{array}{l} \textit{head-func-cxt} \\ \langle \textit{zu, halten} \rangle \\ \text{SYN} \left[\begin{array}{l} \textit{verb} \\ \text{GAP} \langle \boxed{1} \rangle \end{array} \right] \end{array} \right] \right\rangle \end{array} \right]$$

Next, the relative clause in (350) is licensed by the SINGLE-PREDICATE CONSTRUCTION. So, the same addition to the MULTI-PREDICATE CONSTRUCTION must also be made here to allow the realization of gap elements to produce the FILLER-SINGLE-PREDICATE CONSTRUCTION in (352).

(352) FILLER-SINGLE-PREDICATE CONSTRUCTION (\uparrow *predicate-cxt*)

- a.
$$V' \left[\begin{array}{l} \text{VAL} \langle \rangle \\ \text{GAP} \langle \rangle \end{array} \right] \rightarrow \left\{ V \left[\begin{array}{l} \text{VAL} \langle X_1, \dots, X_n, \boxed{1} V \left[\begin{array}{l} \text{VAL} \langle \rangle \\ \text{GAP} \langle F \rangle \end{array} \right] \rangle \right], X_1, \dots, X_n, F, \boxed{1} V \right\}$$
- b. A verbal structure may consist of a sequence of signs, which contains a single verbal predicate that subcategorizes for a subordinate clause which has a gapped sign. The remaining signs consist of the arguments of the predicate and the gapped sign. All of the signs may appear in any order.

c.
$$\textit{filler-s-p-cxt} \Rightarrow \left[\begin{array}{l} \text{MTR} \left[\begin{array}{l} \text{SYN} \left[\begin{array}{l} \text{CAT } Y \\ \text{VAL} \langle \rangle \\ \text{GAP} \langle \rangle \end{array} \right] \end{array} \right] \\ \text{DTRS} \langle H \rangle \circ L_1 \circ \langle F \rangle \circ \langle C \rangle \\ \text{HD-DTR } H : \text{SYN} \left[\begin{array}{l} \text{CAT } Y : [\textit{VF } \textit{fin}] \\ \text{VAL } L_1 \oplus C : \left\langle \left[\begin{array}{l} \textit{clause} \\ \text{SYN} \left[\begin{array}{l} \text{GAP} \langle F \rangle \end{array} \right] \end{array} \right] \right\rangle \end{array} \right] \end{array} \right]$$

A relative clause with a filler is then licensed by the FILLER-RELATIVE-DECL-CLAUSE CONSTRUCTION in (353), and the complete relative clause with embedded infinitival clause has the structure shown in (354).

(353) $filler-rel-decl-cl \Rightarrow vf-cxt \wedge filler-single-pred-cxt \wedge rel-cl$

(354)
$$\left[\begin{array}{l} filler-relative-decl-cl \\ MTR \mid SYN \mid GAP \langle \rangle \\ \\ DTRS \left\langle \begin{array}{l} \boxed{1} \left[\langle \text{über, das} \rangle \right] \\ SYN \mid REL \{ \pi \} \end{array} \right\rangle, \boxed{2} \left[\langle er \rangle \right], \boxed{3} \left[\langle Peter \rangle \right], \left[\begin{array}{l} complex-pred-cxt \\ \langle \text{gebeten, hat} \rangle \\ SYN \mid VAL \langle \boxed{2}, \boxed{3}, \boxed{4} \rangle \end{array} \right], \boxed{4} \left[\begin{array}{l} inf-cl \\ \langle \text{ein., Vor., zu, halt.} \rangle \\ SYN \mid GAP \langle \boxed{1} \rangle \end{array} \right] \right\rangle \end{array} \right]$$

Thus, the two filler variants of the PREDICATE CONSTRUCTIONS can combine with all clause types to permit extraction from an embedded clause to account for non-local phenomena such as the two examples described here. Furthermore, the FILLER CONSTRUCTIONS defined here explicitly only license extraction when the gap comes from an embedded clause. This means that extraction is not permitted in local contexts. Instead, the natural word order flexibility of German allows alternate local linearizations.

5.8 Summary

Having argued in Chapter 3 that complex extraction operations are not always reasonable mechanisms to describe flexible word order, as well as demonstrating in this chapter that binary branching tree structures are no more advantageous, I have provided an analysis of German, a flexible word order language, with flatter, surface-oriented structures and without the use of extraction in local contexts:

§5.1 Mainstream syntactic theory posits that binary branching structure is universal and restricted by a set of genetically-endowed parameters. This results in more complex tree structures and requires abstract mechanisms for which we have no direct evidence. Furthermore, there is cross-linguistic empirical evidence that at least some structures are best viewed as flat, rather than deeply embedded.

§5.2 A flat analysis of flexible word order is facilitated by the separation of constructions which license the saturation of verbal arguments from those which license the linear order of their elements, that is, the PREDICATE and LINEAR CONSTRUCTIONS.

- §5.3 I provide a brief formal introduction to the aspects of Sign-based Construction Grammar which are used throughout the chapter.
- §5.4 All German main V2 clauses are licensed by a small set of sub-types of the PREDICATE and LINEAR CONSTRUCTIONS. These constructions directly characterize the linearization and combinatorial patterns which are directly observable, thus providing a fairly flat analysis without extraction. This analysis can handle a wide range of phenomena including complex predicates in the final verb cluster, partial verb phrases, adjunct scoping, verb third, and coordination as well as some phenomena found problematic under other analyses. For instance, a flat analysis of fronted partial verb phrases allows for proper subject-verb agreement without violating locality restrictions or resorting to additional feature percolation. Also, a flat analysis with MRS-like semantics allows for the ambiguity of adjunct scopes, unlike a binary branching analysis which due to the branching structure would only allow one scoping per word order.
- §5.5 A flat analysis also licenses clauses with non-V2 word orders. The same PREDICATE CONSTRUCTIONS used with V2 clauses can be combined with new LINEAR CONSTRUCTIONS for verb initial and verb final word orders.
- §5.6 Complex sentences which include embedded subordinate clauses also exhibit relatively flat structure. This is achieved by extending the LINEAR CONSTRUCTIONS to include a LINEAR MARKING feature and positing phenomenon-specific constructions. These modifications then allow analyses of complement, relative, and non-finite clauses. This shows that even embedded structures fit into a flat analysis of syntax.
- §5.7 While extraction is not utilized to account for V2 word order, as in other analyses, there are valid instances where long-distance dependencies do exist. When an element must be realized non-locally, that is, in some matrix clause, a variant of the HEAD-FILLER CONSTRUCTION is compatible with a flat analysis. Unlike analyses of V2 via extraction, a flat analysis allows non-local extracted elements to appropriately shuffle with the arguments of the matrix clause.

In all, in this chapter, I support the claims that:

- Flat constructions which characterize complete clausal word orders accurately license flexible as well as verb second word order.
- A complete grammar may consist of only observable or plausibly deducible features and structures.
- A long-distance dependency relation is not necessary to account for the various realizations of flexible word order clauses.
- A relatively small set of constructions can account for a large variety of word orders and clause structures.

Chapter 6

Conclusion

In this dissertation, I have investigated the syntactic properties of flexible word order and its interaction with V2. I have argued that binary branching analyses and those with deeply embedded structures do not plausibly reflect observable data. Such analyses posit extraction processes to allow alternate word order realizations and require underlying structures which cannot be empirically detected. Instead, the word order flexibility of V2 languages suggests that the syntactic structure of such languages is flatter than usually assumed. In response to these observations, I propose a surface-oriented and construction-based approach to word order flexibility and other linear constraints like V2. I show that clause structure is licensed by the combination of two general classes of constructions: those which license the linear placement of elements and those which license argument saturation. These constructions capture observable patterns at the clause level and underspecify the positions of flexible elements. Consequently, this allows multiple linear orders from a single construction. This proposed flat structure is more advantageous than previous approaches in two key ways. First, it naturally accounts for clause level phenomena such as subject agreement with partial verb phrases: Without embedded structures, these clausal constraints are able to directly check agreement features without violating locality restrictions. Second, flat clause structure correctly predicts the behavior of extracted and first position elements of V2 clauses whereas other extraction-based analyses blur the distinction between these phenomena.

The theory of word order that I propose in this dissertation deviates from previous approaches in a fundamental way: Word order is not driven by structural composition. In extraction-based accounts of linearization, word order variants are licensed by structural rules which not only change

the position of elements but also change the constituency of a phrase. Additionally, these rules simultaneously account for valence saturation and satisfy other compositional requirements. Word order domains are also created, propagated, and compacted by compositional rules which are similarly intertwined with all other syntactic constraints. The theory that I posit in this dissertation keeps compositional and valence saturation constraints separate from those which license word order. As a result, there is no base word order whose variants are licensed by changing constituency or the manner in which predicates are saturated. Thus, I propose that the syntax of German is fundamentally different than that of other languages without flexible word order, like English. I am not necessarily committed to the idea that all languages must share basic properties and have the same underlying form (cf. Croft, 2001; Evans and Levinson, 2009). Rather, only the syntactic structure which most plausibly describes observable patterns should be posited. Consequently, the data indicates that German, and other flexible word order languages, have flatter syntactic structure.

In all, this dissertation has made the following core claims:

- A typology of V2 languages shows that flexible word order behaves similarly across languages and that a single approach to flexible word order can be cross-linguistically applicable.
- Transformational approaches to grammar posit covert and empirically unjustified structures whose breadth is not fully understood and has become increasingly complex. Thus, a construction-based approach which more directly encodes observable patterns is therefore more plausible.
- Flexible word order is not the result of a long-distance dependency, particularly in the case of the first element of a V2 clause. A long-distance dependency is only necessary to account for non-local phenomena, such as when an element is extracted to a matrix clause.
- Accumulating evidence indicates that binary branching and deeply embedded structures do not account for general syntactic phenomena including binding and anaphora. Furthermore, other phenomena previously attributed to embedded syntactic structure, such as branching

tendencies, are equally explained by semantic and processing constraints. Thus, a flat analysis is compatible with, if not preferable to, a binary branching approach.

- Flat constructions, which directly encode observable word order patterns, accurately license both flexible and V2 word order by positing the interaction of a relatively small set of combinatorial and linear constraints. This has been demonstrated by a large flat construction-based grammar of German including a wide range of clause structures and syntactic phenomena.

Appendix A

Grammar for Flat Analysis of German

A.1 Type Hierarchies

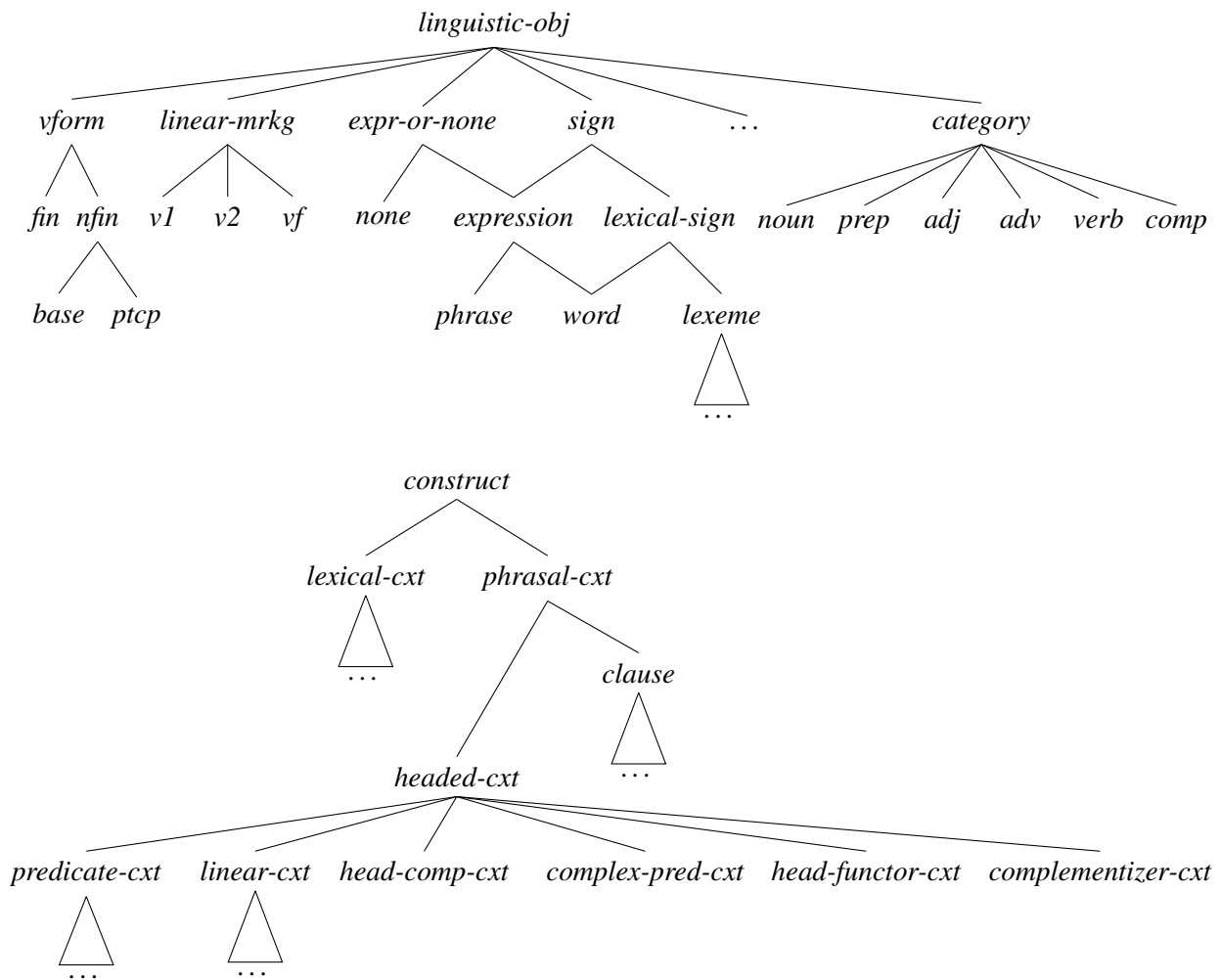

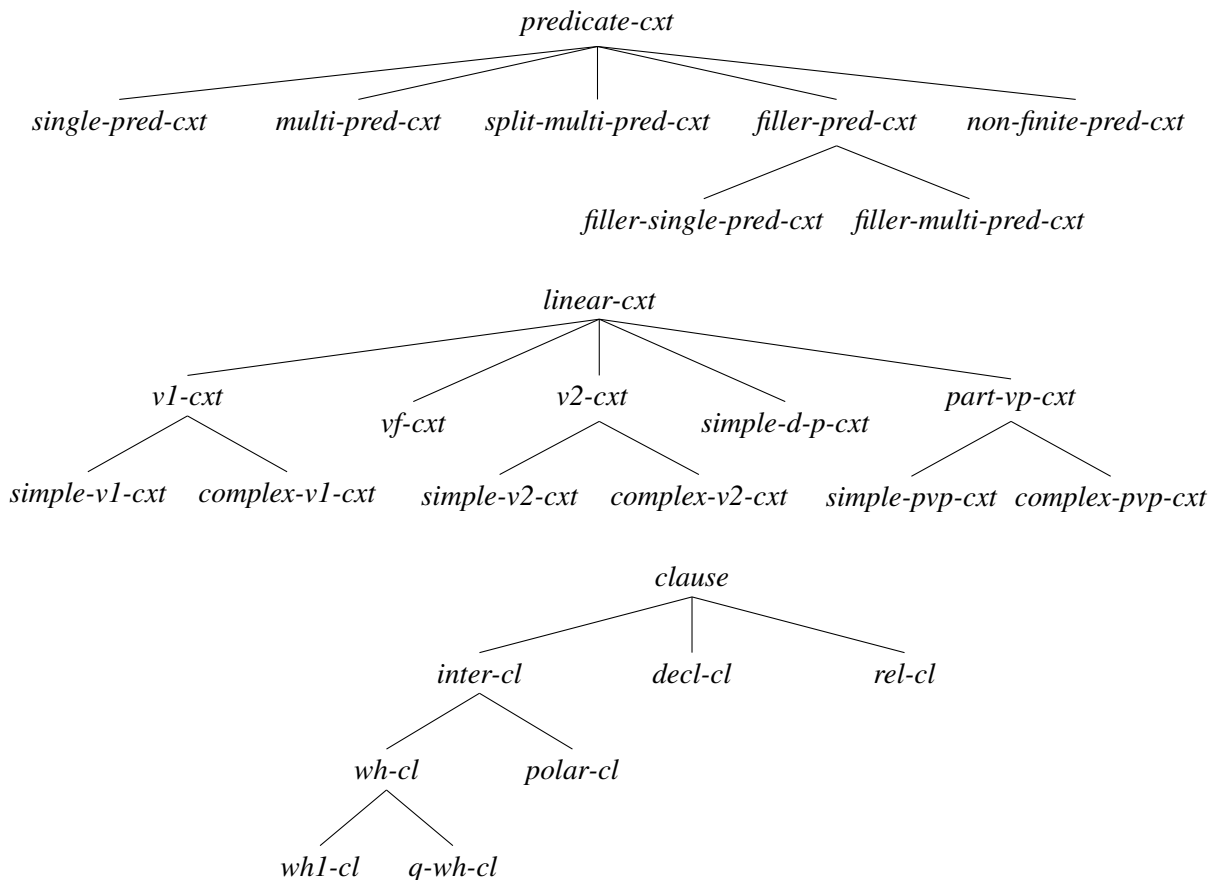

A.2 Type Declarations

$$\text{sign} : \left[\begin{array}{ll} \text{PHON} & \textit{phonological-obj} \\ \text{FORM} & \textit{morphological-obj} \\ \text{SYN} & \textit{syntactic-obj} \\ \text{SEM} & \textit{semantic-obj} \\ \text{CNTXT} & \textit{context-obj} \end{array} \right]$$

$$\text{syntactic-obj} : \left[\begin{array}{ll} \text{CAT} & \textit{category} \\ \text{VAL} & \textit{list(sign)} \\ \text{MRKG} & \textit{mark} \\ \text{LIN-MRKG} & \textit{linear-mrkg} \\ \text{GAP} & \textit{list(sign)} \\ \text{WH} & \textit{set(sign)} \\ \text{REL} & \textit{set(sign)} \end{array} \right]$$

$$\text{semantic-obj} : \left[\begin{array}{ll} \text{LTOP} & \textit{label} \\ \text{FRAMES} & \textit{list(frame)} \end{array} \right]$$

$$\text{context-obj} : \left[\text{MAX-QUD } \text{question} \right]$$

$$\text{category} : \left[\text{SELECT } \text{expr-or-none} \right]$$

$$\text{verb} : \left[\text{VF } \text{vform} \right]$$

$$\text{construct} : \left[\begin{array}{l} \text{MTR } \text{sign} \\ \text{DTRS } \text{list}(\text{expression}) \end{array} \right]$$

$$\text{headed-cxt} : \left[\text{HD-DTR } \text{sign} \right]$$

A.3 Constructions

SIMPLE-V2 CONSTRUCTION (\uparrow *linear-cxt*)

$$\text{simple-v2-cxt} \Rightarrow \left[\begin{array}{l} \text{MTR} \quad \left[\text{SYN} \quad \left[\text{CAT} \quad Y \right] \right] \\ \text{DTRS} \quad \left\langle \left[\text{sign}, H \right] \right\rangle \oplus \text{list} \\ \text{HD-DTR} \quad H : \left[\begin{array}{l} \text{word} \\ \text{SYN} \quad \left[\text{CAT} \quad Y : \left[\text{VF} \quad \text{fn} \right] \right] \end{array} \right] \end{array} \right]$$

SINGLE-PREDICATE CONSTRUCTION (\uparrow *predicate-cxt*)

$$\text{single-pred-cxt} \Rightarrow \left[\begin{array}{l} \text{MTR} \quad \left[\begin{array}{l} \text{SYN} \quad \left[\text{CAT} \quad Y \right] \\ \text{VAL} \quad \langle \rangle \\ \text{SEM} \quad \left[\text{LTOP} \quad l_{0 \geq 1} \right] \end{array} \right] \\ \text{DTRS} \quad \left\langle H \right\rangle \circ L \\ \text{HD-DTR} \quad H : \left[\begin{array}{l} \text{SYN} \quad \left[\text{CAT} \quad Y : \left[\text{VF} \quad \text{fn} \right] \right] \\ \text{VAL} \quad L \\ \text{SEM} \quad \left[\text{LTOP} \quad l_1 \right] \end{array} \right] \end{array} \right]$$

COMPLEX-PREDICATE CONSTRUCTION (\uparrow *headed-cxt*)

$$\text{complex-pred-cxt} \Rightarrow \left[\begin{array}{l} \text{MTR} \quad \left[\text{SYN} \left[\begin{array}{l} \text{CAT} \quad Y \\ \text{VAL} \quad \langle X \rangle \oplus L_1 \oplus L_2 \end{array} \right] \right] \\ \\ \text{DTRS} \quad \langle H \rangle \circ \left\langle Z : \left[\text{SYN} \left[\begin{array}{l} \text{CAT} \quad \left[\text{VF} \quad nfin \right] \\ \text{MRKG} \quad none \\ \text{VAL} \quad \langle X \rangle \oplus L_2 \end{array} \right] \right] \right\rangle \\ \\ \text{HD-DTR} \quad H : \left[\begin{array}{l} \text{word} \\ \text{SYN} \left[\begin{array}{l} \text{CAT} \quad Y : \textit{verb} \\ \text{VAL} \quad \langle X \rangle \oplus (L_1 \circ \langle Z \rangle) \end{array} \right] \end{array} \right] \end{array} \right]$$

COMPLEX-V2 CONSTRUCTION (\uparrow *linear-cxt*)

$$\text{complex-v2-cxt} \Rightarrow \left[\begin{array}{l} \text{MTR} \quad \left[\text{SYN} \left[\begin{array}{l} \text{CAT} \quad Y \end{array} \right] \right] \\ \\ \text{DTRS} \quad \left\langle \left[\textit{sign}, H \right] \oplus list \oplus \right. \\ \quad \left. \left\langle Z : \left[\text{SYN} \left[\begin{array}{l} \text{CAT} \quad \left[\text{VF} \quad nfin \right] \end{array} \right] \right] \right\rangle \oplus list \left(\left[\text{EXTRA} + \right] \right) \right\rangle \\ \\ \text{HD-DTR} \quad H : \left[\begin{array}{l} \text{word} \\ \text{SYN} \left[\begin{array}{l} \text{CAT} \quad Y : \left[\text{VF} \quad fin \right] \\ \text{VAL} \quad \langle Z \rangle \circ list \end{array} \right] \end{array} \right] \end{array} \right]$$

MULTI-PREDICATE CONSTRUCTION (\uparrow *predicate-cxt*)

$$\text{multi-pred-cxt} \Rightarrow \left[\begin{array}{l} \text{MTR} \quad \left[\begin{array}{l} \text{SYN} \left[\begin{array}{l} \text{CAT} \quad Y \\ \text{VAL} \quad \langle \rangle \end{array} \right] \\ \text{SEM} \left[\begin{array}{l} \text{LTOP} \quad l_{0 \geq 1} \end{array} \right] \end{array} \right] \\ \\ \text{DTRS} \quad \langle H \rangle \circ Z : \left[\text{SYN} \left[\begin{array}{l} \text{CAT} \quad \left[\text{VF} \quad nfin \right] \\ \text{VAL} \quad \langle X \rangle \oplus L \end{array} \right] \right] \circ \langle X \rangle \circ L \\ \\ \text{HD-DTR} \quad H : \left[\begin{array}{l} \text{word} \\ \text{SYN} \left[\begin{array}{l} \text{CAT} \quad Y : \left[\text{VF} \quad fin \right] \\ \text{VAL} \quad \langle X, Z \rangle \end{array} \right] \\ \text{SEM} \left[\begin{array}{l} \text{LTOP} \quad l_1 \end{array} \right] \end{array} \right] \end{array} \right]$$

SIMPLE-PARTIAL-VERB-PHRASE CONSTRUCTION (\uparrow *linear-cxt*)

$$\text{partial-vp-cxt} \Rightarrow \left[\begin{array}{l} \text{MTR} \quad \left[\text{SYN} \quad \left[\text{CAT} \quad Y \right] \right] \\ \text{DTRS} \quad \text{list} \oplus \left\langle Z : \left[\text{SYN} \left[\text{CAT} \quad \left[\text{VF} \quad \text{nfn} \right] \right] \right], H \right\rangle \oplus \text{list} \\ \text{HD-DTR} \quad H : \left[\begin{array}{l} \text{word} \\ \text{SYN} \quad \left[\text{CAT} \quad Y : \left[\text{VF} \quad \text{fn} \right] \right] \\ \text{VAL} \quad \langle Z \rangle \circ \text{list} \end{array} \right] \end{array} \right]$$

COMPLEX-PARTIAL-VERB-PHRASE CONSTRUCTION (\uparrow *linear-cxt*)

$$\text{complex-pvp-cxt} \Rightarrow \left[\begin{array}{l} \text{MTR} \quad \left[\text{SYN} \quad \left[\text{CAT} \quad Y \right] \right] \\ \text{DTRS} \quad \text{list} \oplus \left\langle Z_2 : \left[\text{SYN} \left[\text{CAT} \quad \left[\text{VF} \quad \text{nfn} \right] \right] \right], H \right\rangle \oplus \text{list} \oplus \\ \left\langle Z_1 : \left[\text{SYN} \left[\text{CAT} \quad \left[\text{VF} \quad \text{nfn} \right] \right] \right], \text{VAL} \quad \langle Z_2 \rangle \circ \text{list} \right\rangle \oplus \text{list} \left(\left[\text{EXTRA} + \right] \right) \\ \text{HD-DTR} \quad H : \left[\begin{array}{l} \text{word} \\ \text{SYN} \quad \left[\text{CAT} \quad Y : \left[\text{VF} \quad \text{fn} \right] \right] \\ \text{VAL} \quad \langle Z_1 \rangle \circ \text{list} \end{array} \right] \end{array} \right]$$

LEXICAL-ADJUNCT CONSTRUCTION (\uparrow *lexical-cxt*)

$$\text{lex-mod-cxt} \Rightarrow \left[\begin{array}{l} \text{MTR} \quad \left[\text{ARG-ST} \quad L \oplus \text{list} \left(\left[\text{SELECT} \quad H \right] \right) \right] \\ \text{DTRS} \quad \left\langle H : \left[\text{ARG-ST} \quad L \right] \right\rangle \\ \text{HD-DTR} \quad H \end{array} \right]$$

SPLIT-MULTI-PREDICATE CONSTRUCTION (\uparrow *predicate-cxt*)

$$\text{split-multi-pred-cxt} \Rightarrow \left[\begin{array}{l} \text{MTR} \quad \left[\begin{array}{l} \text{SYN} \quad \left[\begin{array}{l} \text{CAT} \quad Y \\ \text{VAL} \quad \langle \rangle \end{array} \right] \\ \text{SEM} \quad \left[\begin{array}{l} \text{LTOP} \quad l_{0 \geq 1} \end{array} \right] \end{array} \right] \\ \\ \text{DTRS} \quad \langle H \rangle \circ Z_1 : \left[\begin{array}{l} \text{SYN} \quad \left[\begin{array}{l} \text{CAT} \quad \left[\begin{array}{l} \text{VF} \quad nfin \end{array} \right] \\ \text{VAL} \quad \langle X, Z_2 \rangle \end{array} \right] \end{array} \right] \circ \\ \\ Z_2 : \left[\begin{array}{l} \text{SYN} \quad \left[\begin{array}{l} \text{CAT} \quad \left[\begin{array}{l} \text{VF} \quad nfin \end{array} \right] \\ \text{VAL} \quad \langle X \rangle \oplus L \end{array} \right] \end{array} \right] \circ \langle X \rangle \circ L \\ \\ \text{HD-DTR} \quad H : \left[\begin{array}{l} \text{word} \\ \text{SYN} \quad \left[\begin{array}{l} \text{CAT} \quad Y : \left[\begin{array}{l} \text{VF} \quad fin \end{array} \right] \\ \text{VAL} \quad \langle X, Z_1 \rangle \end{array} \right] \\ \text{SEM} \quad \left[\begin{array}{l} \text{LTOP} \quad l_1 \end{array} \right] \end{array} \right] \end{array} \right] \end{array} \right]$$

SIMPLE-DISOURSE-PROMINENCE CONSTRUCTION (\uparrow *linear-cxt*)

$$\text{simple-disc-prom-cxt} \Rightarrow \left[\begin{array}{l} \text{MTR} \quad \left[\begin{array}{l} \text{SYN} \quad \left[\begin{array}{l} \text{CAT} \quad Y \end{array} \right] \end{array} \right] \\ \\ \text{DTRS} \quad \text{list} \left(\left[\begin{array}{l} \text{PROM} \quad + \end{array} \right] \right) \oplus \langle H \rangle \oplus \text{list} \\ \\ \text{HD-DTR} \quad H : \left[\begin{array}{l} \text{word} \\ \text{SYN} \quad \left[\begin{array}{l} \text{CAT} \quad Y : \left[\begin{array}{l} \text{VF} \quad fin \end{array} \right] \end{array} \right] \end{array} \right] \end{array} \right] \end{array} \right]$$

WH-FIRST-CLAUSE CONSTRUCTION (\uparrow *wh-cl*)

$$\text{wh1-cl} \Rightarrow \left[\begin{array}{l} \text{MTR} \quad \left[\begin{array}{l} \text{SYN} \quad \left[\begin{array}{l} \text{WH} \quad \{ \} \end{array} \right] \end{array} \right] \\ \\ \text{DTRS} \quad \left\langle \left[\begin{array}{l} \text{SYN} \quad \left[\begin{array}{l} \text{WH} \quad \{ \pi \} \end{array} \right] \end{array} \right] \right\rangle \oplus \text{list} \end{array} \right]$$

QUD-WH-CLAUSE CONSTRUCTION (\uparrow *wh-cl*)

$$\text{qud-wh-cl} \Rightarrow \left[\begin{array}{l} \text{MTR} \quad \left[\begin{array}{l} \text{SYN} \quad \left[\begin{array}{l} \text{WH} \quad \{ \} \end{array} \right] \\ \text{CNTXT} \quad \left[\begin{array}{l} \text{MAX-QUD} \quad \text{question} \end{array} \right] \end{array} \right] \\ \\ \text{DTRS} \quad \text{nelist} \left(\left[\begin{array}{l} \text{SYN} \quad \left[\begin{array}{l} \text{WH} \quad \{ \pi \} \end{array} \right] \end{array} \right] \right) \circ \text{list} \end{array} \right]$$

SIMPLE-V1 CONSTRUCTION (\uparrow *linear-cxt*)

$$simple-v1-cxt \Rightarrow \left[\begin{array}{l} \text{MTR} \quad \left[\text{SYN} \quad \left[\text{CAT} \quad Y \right] \right] \\ \text{DTRS} \quad \langle H \rangle \oplus list \\ \text{HD-DTR} \quad H : \left[\begin{array}{l} word \\ \text{SYN} \quad \left[\text{CAT} \quad Y : \left[\text{VF} \quad fn \right] \right] \end{array} \right] \end{array} \right]$$

COMPLEX-V1 CONSTRUCTION (\uparrow *linear-cxt*)

$$complex-v1-cxt \Rightarrow \left[\begin{array}{l} \text{MTR} \quad \left[\text{SYN} \quad \left[\text{CAT} \quad Y \right] \right] \\ \text{DTRS} \quad \langle H \rangle \oplus list \oplus \left\langle Z : \left[\text{SYN} \quad \left[\text{CAT} \quad \left[\text{VF} \quad nfn \right] \right] \right] \right\rangle \oplus \\ \quad list \left(\left[\text{EXTRA} \quad + \right] \right) \\ \text{HD-DTR} \quad H : \left[\begin{array}{l} word \\ \text{SYN} \quad \left[\begin{array}{l} \text{CAT} \quad Y : \left[\text{VF} \quad fn \right] \\ \text{VAL} \quad \langle Z \rangle \circ list \end{array} \right] \end{array} \right] \end{array} \right]$$

VF CONSTRUCTION (\uparrow *linear-cxt*)

$$vf-cxt \Rightarrow \left[\begin{array}{l} \text{MTR} \quad \left[\text{SYN} \quad \left[\begin{array}{l} \text{CAT} \quad Y \\ \text{LIN-MRKG} \quad vf \end{array} \right] \right] \\ \text{DTRS} \quad list \oplus \langle H \rangle \\ \text{HD-DTR} \quad H : \left[\text{SYN} \quad \left[\text{CAT} \quad Y : \left[\text{VF} \quad fn \right] \right] \right] \end{array} \right]$$

V1 CONSTRUCTION (\uparrow *linear-cxt*)

$$v1-cxt \Rightarrow \left[\text{MTR} \quad \left[\text{SYN} \quad \left[\text{LIN-MRKG} \quad v1 \right] \right] \right]$$

V2 CONSTRUCTION (\uparrow *linear-cxt*)

$$v2-cxt \Rightarrow \left[\text{MTR} \quad \left[\text{SYN} \quad \left[\text{LIN-MRKG} \quad v2 \right] \right] \right]$$

HEAD-FUNCTOR CONSTRUCTION (\uparrow *headed-cxt*)

$$head\text{-}func\text{-}cxt \Rightarrow \left[\begin{array}{l} \text{MTR} \quad \left[\text{SYN } X \ ! \left[\text{MRKG } M \right] \right] \\ \text{DTRS} \quad \left\langle \left[\text{SYN} \quad \left[\text{CAT} \quad \left[\text{SELECT } Y \right] \right] \right. \right. \\ \quad \left. \left. \left[\text{MRKG } M \right] \right] \right\rangle, Y : \left[\text{SYN } X \right] \rangle \\ \text{HD-DTR} \quad Y \end{array} \right]$$

COMPLEMENTIZER CONSTRUCTION (\uparrow *headed-cxt*)

$$complementizer\text{-}cxt \Rightarrow \left[\begin{array}{l} \text{DTRS} \quad \left\langle \left[\text{SYN} \quad \left[\text{CAT} \quad \left[\text{comp} \right] \right] \right], H \right\rangle \\ \text{HD-DTR} \quad H : \left[\text{SYN} \quad \left[\text{CAT} \quad \left[\text{VF } fin \right] \right] \right] \\ \quad \left[\text{LIN-MRKG } vf \right] \\ \quad \left[\text{VAL} \quad \langle \rangle \right] \end{array} \right]$$

RELATIVE-CLAUSE CONSTRUCTION (\uparrow *clause*)

$$rel\text{-}cl \Rightarrow \left[\begin{array}{l} \text{MTR} \quad \left[\text{SYN} \quad \left[\text{REL} \quad \{ \} \right] \right] \\ \text{DTRS} \quad \left\langle \left[\text{SYN} \quad \left[\text{REL} \quad \{ \pi \} \right] \right] \right\rangle \oplus list \end{array} \right]$$

NON-FINITE-PREDICATE CONSTRUCTION (\uparrow *predicate-cxt*)

$$non\text{-}fin\text{-}pred\text{-}cxt \Rightarrow \left[\begin{array}{l} \text{MTR} \quad \left[\text{SYN} \quad \left[\text{CAT} \quad Y \right] \right] \\ \quad \left[\text{VAL} \quad \langle X \rangle \right] \\ \text{DTRS} \quad L \oplus \langle H \rangle \\ \text{HD-DTR} \quad H : \left[\text{SYN} \quad \left[\text{CAT} \quad Y : \left[\text{VF } nfin \right] \right] \right] \\ \quad \left[\text{MRKG } inf \right] \\ \quad \left[\text{VAL} \quad \langle X \rangle \oplus L \right] \end{array} \right]$$

FILLER-MULTI-PREDICATE CONSTRUCTION (\uparrow *filler-pred-cxt*)

$$\begin{array}{l}
 \text{filler-}m\text{-}p\text{-cxt} \Rightarrow \left[\begin{array}{l}
 \text{MTR} \quad \left[\text{SYN} \quad \left[\begin{array}{l} \text{CAT} \quad Y \\ \text{VAL} \quad \langle \rangle \\ \text{GAP} \quad \langle \rangle \end{array} \right] \right] \\
 \text{DTRS} \quad \langle H \rangle \circ \langle X \rangle \circ L_1 \circ \langle F \rangle \circ \langle C \rangle \circ \\
 \left\langle Z : \text{SYN} \quad \left[\begin{array}{l} \text{CAT} \quad [VF \quad nfin] \\ \text{VAL} \quad \langle X \rangle \oplus L_1 \oplus \\ C : \left\langle \begin{array}{l} \text{clause} \\ \text{SYN} \quad \left[\text{GAP} \quad \langle F \rangle \right] \right\rangle \right] \right] \right\rangle \\
 \text{HD-DTR} \quad H : \left[\begin{array}{l} \text{word} \\ \text{SYN} \quad \left[\begin{array}{l} \text{CAT} \quad Y : [VF \quad fin] \\ \text{VAL} \quad \langle X, Z \rangle \end{array} \right] \right] \end{array} \right] \end{array} \right]
 \end{array}
 \end{array}$$

FILLER-SINGLE-PREDICATE CONSTRUCTION (\uparrow *filler-pred-cxt*)

$$\begin{array}{l}
 \text{filler-}s\text{-}p\text{-cxt} \Rightarrow \left[\begin{array}{l}
 \text{MTR} \quad \left[\text{SYN} \quad \left[\begin{array}{l} \text{CAT} \quad Y \\ \text{VAL} \quad \langle \rangle \\ \text{GAP} \quad \langle \rangle \end{array} \right] \right] \\
 \text{DTRS} \quad \langle H \rangle \circ L_1 \circ \langle F \rangle \circ \langle C \rangle \\
 \text{HD-DTR} \quad H : \left[\begin{array}{l} \text{SYN} \quad \left[\begin{array}{l} \text{CAT} \quad Y : [VF \quad fin] \\ \text{VAL} \quad L_1 \oplus C : \left\langle \begin{array}{l} \text{clause} \\ \text{SYN} \quad \left[\text{GAP} \quad \langle F \rangle \right] \right\rangle \right] \right] \end{array} \right] \end{array} \right]
 \end{array} \right]
 \end{array}$$

References

- Abeillé, Anne and Godard, Danièle. 2002. The Syntactic Structure of French Auxiliaries. *Language* 78(3), 404–452.
- Abeillé, Anne and Godard, Danièle. 2010. Complex Predicates in the Romance Languages. In Danièle Godard (ed.), *Fundamental Issues in the Romance Languages*, pages 107–170, Stanford: CSLI Publications.
- Akhtar, Nameera, Callanan, Maureen and Pullum, Geoffrey K. 2004. Learning antecedents for anaphoric one. *Cognition* 93, 141–145.
- Anderson, Stephen R. 2005. *Aspects of the Theory of Clitics*. Oxford: Oxford University.
- Artstein, Ron. 2005. Coordination of parts of words. *Lingua* 115(4), 359–393.
- Askedal, John Ole. 1986. Über “Stellungsfelder” und “Satztypen” im Deutschen. *Deutsche Sprache* 14, 193–223.
- Baker, C. L. 1978. *Introduction to Generative Transformational Syntax*. Englewood Cliffs, NJ: Prentice-Hall.
- Ball, Martin J. and Fife, James (eds.). 2002. London/New York: Routledge.
- Beavers, John and Sag, Ivan A. 2004. Coordinate Ellipsis and Apparent Non-Constituent Coordination. In Stefan Müller (ed.), *Proceedings of the HPSG04 Conference*, Stanford, CA: CSLI Publications.
- Beneš, Eduard. 1971. Die Besetzung der ersten Position im deutschen Aussagesatz. In Hugo Moser (ed.), *Fragen der strukturellen Syntax und der kontrastiven Grammatik*, Sprache der Gegenwart

- Schriften des IdS Mannheim, No. 17, pages 160–182, Düsseldorf: Pädagogischer Verlag Schwann.
- Bever, Thomas. 1970. The Cognitive Basis for Linguistic Structures. In J. R. Hayes (ed.), *Cognition and the Development of Language*, New York: Wiley.
- Bhatt, Rakesh Mohan. 1999. *Verb Movement and the Syntax of Kashmiri*. Dordrecht: Kluwer Academic Publishers.
- Blevins, J. P. and Sag, Ivan A. 1996. Constituent Sharing in Nonconstituent Coordination, unpublished Ms., University of Alberta and Stanford University.
- Bloomfield, Leonard. 1933. *Language*. New York: H. Holt and Company.
- Boas, Hans and Sag, Ivan A. (eds.). 2012. *Sign-Based Construction Grammar*. Stanford: CSLI Publications.
- Borsley, Robert D. and Kathol, Andreas. 2000. Breton as a V2 language. *Linguistics* 38, 665–710.
- Bouma, Gosse, Malouf, Robert and Sag, Ivan A. 2001. Satisfying Constraints on Extraction and Adjunction. In *Natural Language and Linguistic Theory*, volume 19, pages 1–65.
- Bunt, Harry. 1996. Formal tools for describing and processing discontinuous constituent structure. In Bunt and van Horck (1996), pages 63–85.
- Bunt, Harry and van Horck, Arthur (eds.). 1996. *Discontinuous Constituency*. Berlin/New York: Mouton de Gruyter.
- Carpenter, Bob. 1992. *The Logic of Typed Feature Structures*. Cambridge University Press.
- Chaves, Rui P. 2008. Linearization-based Word-Part Ellipsis. *Linguistics and Philosophy* 31(3), 261–307.
- Chaves, Rui P. 2009. Construction-based Cumulation and Adjunct Extraction. In Stefan Müller (ed.), *Proceedings of the HPSG 2009 Conference*, Stanford, CA: CSLI Publications.

- Chaves, Rui P. 2014. On the disunity of right-node raising phenomena: Extraposition, ellipsis, and deletion. *Language* 90(4).
- Chomsky, Noam. 1965. *Aspects of the Theory of Syntax*. Cambridge, MA: MIT Press.
- Chomsky, Noam. 1968. Language and the Mind. *Psychology Today* 1(9).
- Chomsky, Noam. 1981. *Lectures on Government and Binding*. Dordrecht, Holland: Foris.
- Clematide, Simon R. 2009. *Koordination im Deutschen und ihre syntaktische Desambiguierung*. Ph. D.thesis, University of Zurich.
- Cook, Philippa. 2014. Between complex predicates and regular phrases: some collocational combinations in German, abstract for the 21th International Conference on HPSG.
- Copestake, Ann, Flickinger, Dan, Pollard, Carl and Sag, Ivan A. 2005. Minimal Recursion Semantics: An Introduction. *Research on Language and Computation* 3(2-3), 281–332.
- Corver, Norbert and van Riemsdijk, Henk (eds.). 1994. *Movement and Non-Movement Approaches to Free Word-Order Phenomena*. Studies on Scrambling, Berlin/New York: Mouton de Gruyter.
- Crain, Steven and Steedman, Mark. 1985. On Not Being Led Up the Garden Path: The Use of Context by the Psychological Syntax Processor. In David R. Dowty, Lauri Karttunen and Arnold M. Zwicky (eds.), *Natural Language Processing*, Cambridge: Cambridge University Press.
- Croft, William. 2001. *Radical construction grammar: syntactic theory in typological perspective*. Oxford: Oxford University Press.
- Culicover, Peter W. 1997. *Principles and Parameters: An Introduction to the Theory of Government and Binding and Its Extensions*. Oxford: Oxford University Press.
- Culicover, Peter W. 1999. *Syntactic Nuts: Hard Cases, Syntactic Theory, and Language Acquisition*. Oxford: Oxford University Press.
- Culicover, Peter W. and Jackendoff, Ray. 2005. *Simpler Syntax*. Oxford University Press.

- Curry, Haskell B. 1961. Some logical aspects of grammatical structure. In P. Jacobson (ed.), *Studies of Language and its Grammatical Aspects: Proceedings of the Twelfth Symposium in Applied Mathematics*, pages 56–68, American Mathematical Society.
- Davis, Anthony R. and Koenig, Jean-Pierre. 2000. Linking as Constraints on Word Classes in a Hierarchical Lexicon. *Language* 76, 56–91.
- De Kuthy, Kordula. 2002. *Discontinuous NPs in German: A Case Study of the Interaction of Syntax, Semantics, and Pragmatics*. Studies in Constraint-Based Lexicalism, Stanford, CA: CSLI Publications.
- Diesing, Molly. 1990. Verb Movement and the Subject Position in Yiddish. *Natural Language and Linguistic Theory* 8(1), 41–79.
- Donohue, Cathryn and Sag, Ivan A. 1999. Domains in Warlpiri. In *Sixth International Conference on HPSG—Abstracts*, pages 101–106, Edinburgh.
- Dowty, David. 2003. The Dual Analysis of Adjuncts/Complements in Categorical Grammar. In Maienborn Lang and Fabricius Hansen (eds.), *Modifying Adjuncts*, pages 33–66, de Gruyter.
- Dowty, David R. 1996. Towards a Minimalist Theory of Syntactic Structure. In Bunt and van Horck (1996), pages 11–62.
- Drach, Erich. 1937. *Grundgedanken der deutschen Satzlehre*. Frankfurt: Diesterweg.
- Dryer, Matthew S. 1992. The Greenbergian Word Order Correlations. *Language* 68, 81–138.
- Dryer, Matthew S. 2008. The Branching Direction Theory Revisited. In Sergio Scalise, Elisabetta Magni and Antonietta Bisetto (eds.), *Universals of Language*, Berlin: Springer.
- Dudenredaktion. 2005. *Duden: Die Grammatik*, volume 4. Mannheim: Dudenverlag.
- Eisenberg, Peter. 1994. German. In König and van der Auwera (1994), pages 349–387.
- Evans, Nicholas and Levinson, Stephen C. 2009. The myth of language universals: Language diversity and its importance for cognitive science. *Behavioral and Brain Sciences* 32, 429–492.

- Fife, James. 2002. Introduction. In Ball and Fife (2002), pages 3–25.
- Fillmore, Charles J., Johnson, Christopher R. and Petruck, Miriam R.L. 2003. Background to Framenet. *International Journal of Lexicography* 16(3), 235–250.
- Fillmore, Charles J., Kay, Paul and O'Connor, Mary Catherine. 1988. Regularity and idiomacy in grammatical constructions: the case of *let alone*. *Language* 64, 501–538.
- Fodor, Jerry, Bever, Thomas and Garrett, Merrill. 1974. *The Psychology of Language*. New York: McGraw-Hill.
- Foraker, Stephani, Regier, Terry, Khetarpal, Naveen, Perfors, Amy and Tenenbaum, Joshua. 2009. Indirect evidence and the poverty of the stimulus: The case of anaphoric one. *Cognitive Science* 33, 287–300.
- Frey, Werner. 1993. *Syntaktische Bedingungen für die Interpretation*. Studia Grammatica, No. 35, Berlin: Akademie Verlag.
- Gazdar, Gerald, Klein, Ewan, Pullum, Geoffrey and Sag, Ivan. 1985. *Generalized Phrase Structure Grammar*. Cambridge, MA: Harvard University Press.
- Gazdar, Gerald, Pullum, Geoffrey, Sag, Ivan A. and Wasow, Thomas. 1980. Coordination and Transformational Grammar. *Linguistic Inquiry* 13(4), 663–677.
- Gibson, Edward. 2000. The Dependency Locality Theory: A Distance-Based Theory of Linguistic Complexity. In A. Maranty, Y. Miyashita and W. O'Neil (eds.), *Image, language, brain: Papers from the first mind articulation project symposium*, pages 95–126, Cambridge, MA: MIT Press.
- Ginzburg, Jonathan and Sag, Ivan A. 2000. *Interrogative Investigations: The Form, Meaning, and Use of English Interrogatives*. Stanford, CA: CSLI Publications.
- Goldberg, Adele E. 1995. *Constructions: A Construction Grammar Approach to Argument Structure*. Chicago: The University of Chicago Press.

- Haegeman, Liliane M. V. 1992. *Theory and Description in Generative Syntax: A Case Study in West Flemish*. Cambridge, England: Cambridge University Press.
- Hale, Ken. 1983. Warlpiri and the Grammar of Non-Configurational Languages. *Natural Language and Linguistic Theory* 1(1), 5–47.
- Hale, Kenneth. 1994. Core structures and adjunctions in Warlpiri syntax. In Corver and van Riemsdijk (1994), pages 185–219.
- Harman, Gilbert H. 1963. Generative Grammars Without Transformational Rules: A Defense of Phrase Structure. *Language* 39, 597–616.
- Hartmann, Katharina. 2000. *Right Node Raising and Gapping: Interface Conditions on Prosodic Deletion*. J. Benjamins.
- Hawkins, John A. 1994. *A Performance Theory of Order and Constituency*. Cambridge: Cambridge University Press.
- Hawkins, John A. 2004. *Efficiency and Complexity in Grammars*. Oxford: Oxford University.
- Hinrichs, Erhard and Nakazawa, Tsuneko. 1994. Linearizing AUXs in German Verbal Complexes. In Nerbonne et al. (1994), pages 11–38.
- Hinrichs, Erhard W. and Nakazawa, Tsuneko. 1998. Third Construction and VP Extraposition in German: An HPSG Analysis. In Erhard Hinrichs, Andreas Kathol and Tsuneko Nakazawa (eds.), *Complex Predicates in Nonderivational Syntax*, volume 30 of *Syntax and Semantics*, pages 115–157, San Diego, California: Academic Press.
- Höhle, Tilman. 1986. Der Begriff “Mittelfeld”, Anmerkungen über die Theorie der topologischen Felder. In Albrecht Schöne (ed.), *Kontroversen, alte und neue: Akten des 7. Internationalen Germanisten-Kongresses, Göttingen*, volume 3, pages 329–340, Tübingen: Niemeyer.
- Huddleston, R. D. 1999. Sentence Types and Clause Subordination. In Keith Brown and Jim Miller (eds.), *Concise Encyclopedia of Grammatical Categories*, Oxford: Elsevier.

- Huddleston, Rodney D., Payne, John and Peterson, Peter. 2002. Chapter 15: Coordination and supplementation. In *The Cambridge Grammar of the English Language*, pages 1273–1362, Cambridge University Press.
- Hukari, Thomas E. and Levine, Robert D. 1995. Adjunct Extraction. *Journal of Linguistics* 31(2), 195–226.
- Jacobs, Neil G., Prince, Ellen F. and van der Auwera, Johan. 1994. Yiddish. In König and van der Auwera (1994), pages 388–419.
- Jacobson, Pauline. 1987. Phrase Structure, Grammatical Relations, and Discontinuous Constituents. In Geoffrey J. Huck and Almerindo E. Ojeda (eds.), *Discontinuous Constituency*, volume 20 of *Syntax and Semantics*, pages 27–69, New York: Academic Press.
- Jouitteau, Mélanie. 2010. A typology of V2 with regard to V1 and second position phenomena: An introduction to the V1/V2 volume. *Lingua* 120(2), 197–209.
- Kasper, Robert. 1994. Adjuncts in the Mittelfeld. In John Nerbonne, Klaus Netter and Carl Pollard (eds.), *German in Head-Driven Phrase Structure Grammar*, CSLI Lecture Notes, No. 46, pages 39–69, Stanford, California: CSLI Publications.
- Kathol, Andreas. 2000. *Linear Syntax*. Oxford: Oxford University.
- Kathol, Andreas. 2003. Subjects in Fronted German VPs and the Problem of Case and Agreement: Shared Argument Structures for Discontinuous Predicates. In Jong-Bok Kim and Stephen Wechsler (eds.), *The Proceedings of the 9th International Conference on HPSG*, CSLI Publications.
- Kathol, Andreas and Pollard, Carl. 1995. Extraposition via Complex Domain Formation. In *Proceedings of the 33rd Annual Meeting of the Association for Computational Linguistics*, pages 174–180.
- Kay, Paul and Fillmore, Charles J. 1999. Grammatical constructions and linguistic generalizations: The *What's X doing Y?* construction. *Language* 75, 1–33.

- King, Tracy Holloway. 1993. *Configuring topic and focus in Russian*. Ph. D.thesis, Stanford University.
- Kiss, Tibor. 1994. Obligatory Coherence: The Structure of German Modal Verb Constructions. In Nerbonne et al. (1994), pages 71–107.
- Klein, Ewan and Sag, Ivan A. 1985. Type-Driven Translation. *Linguistics and Philosophy* 8(2), 163–201.
- Koenig, Jean-Pierre and Davis, Anthony R. 2006. The KEY to Lexical Semantic Representations. *Journal of Linguistics* 42, 71–108.
- Koenig, Jean-Pierre, Mauner, Gail and Bienvenue, Breton. 2003. Arguments for adjuncts. *Cognition* 89, 67–103.
- König, Ekkehard and van der Auwera, Johan (eds.). 1994. *The Germanic Languages*. London/New York: Routledge.
- Landin, David J. 1984. An Outline of the Syntactic Structure of Karitiâna Sentences. In Robert Dooley (ed.), *Estudos Sobre Línguas Tupi do Brasil*, volume 11, pages 219–254, Brasilia: SIL Press.
- Landin, Rachel M. 1982. Word Order Variation in Karitiâna. In *Arquivo Linguístico*, No. 149, Brasilia: SIL Press.
- Lee, Young-Suk and Santorini, Beatrice. 1994. Towards resolving Weibelhuth's paradox: evidence from German and Korean. In Corver and van Riemsdijk (1994), pages 257–300.
- Levine, Robert D. 2003. Adjunct valents, cumulative scopings and impossible descriptions. In Jong-Bok Kim and Stephen Wechsler (eds.), *Proceedings of the 9th International Conference on Head-driven Phrase Structure Grammar*, pages 209–232.
- Levine, Robert D. and Hukari, Thomas E. 2006. *The Unity of Unbounded Dependency Constructions*. Stanford: CSLI Publications.

- Lidz, Jeffrey and Waxman, Sandra. 2004. Reaffirming the poverty of the stimulus argument: A reply to the replies. *Cognition* 93, 157–165.
- Lidz, Jeffrey, Waxman, Sandra and Freedman, Jennifer. 2003. What infants know about syntax but couldn't have learned: Experimental evidence for syntactic structure at 18 months. *Cognition* 89, B65–B73.
- Michaelis, Laura A. 2012. Making the Case for Construction Grammar. In Boas and Sag (2012), pages 31–67.
- Müller, Stefan. 2002. *Complex Predicates: Verbal Complexes, Resultative Constructions, and Particle Verbs in German*. Stanford, CA: CSLI Publications.
- Müller, Stefan. 2003. Mehrfache Vorfeldbesetzung. *Deutsche Sprache* 31(1), 29–62.
- Müller, Stefan. 2004. Continuous or Discontinuous Constituents? A Comparison between Syntactic Analyses for Constituent Order and Their Processing Systems. *Research on Language and Computation, Special Issue on Linguistic Theory and Grammar Implementation* 2(2), 209–257.
- Müller, Stefan. 2005a. Zur Analyse der deutschen Satzstruktur. *Linguistische Berichte* 201, 3–39.
- Müller, Stefan. 2005b. Zur Analyse der scheinbar mehrfachen Vorfeldbesetzung. *Linguistische Berichte* 203, 297–330.
- Müller, Stefan. 2007. *Head-Driven Phrase Structure Grammar: Eine Einführung*. Stauffenburg Einführungen, No. 17, Tübingen: Stauffenburg Verlag.
- Müller, Stefan. 2008. *Head-Driven Phrase Structure Grammar: Eine Einführung*. Stauffenburg Einführungen, No. 17, Tübingen: Stauffenburg Verlag, second revised edition.
- Munn, Alan. 1993. *Topics in the Syntax and Semantics of Coordinate Structures*. Ph.D.thesis, University of Maryland.
- Nerbonne, John. 1994. Partial Verb Phrases and Spurious Ambiguities. In Nerbonne et al. (1994), pages 109–150.

- Nerbonne, John A., Netter, Klaus and Pollard, Carl Jesse (eds.). 1994. *German in Head-Driven Phrase Structure Grammar*. Stanford, CA: CSLI Publications.
- Newmeyer, Frederick J. 2004. Against a parameter-setting approach to typological variation. In Pierre Pica, Johan Rooryck and Jeroen Van Craenenbroeck (eds.), *Linguistic Variation Yearbook*.
- Nichols, Johanna. 2009. Germanic-like verb-second/verb-final word order in Nakh languages, handout at LSA Annual Meeting, San Francisco, Jan. 10.
- Nordlinger, Rachel. 1998. *Constructive Case: Evidence from Australian Languages*. Dissertations in Linguistics, Stanford, CA: CSLI Publications.
- Payne, John and Berlage, Eva. 2009. Pro-nominal one and relational nouns, paper presented at ICAME 30, University of Lancaster.
- Payne, John, Pullum, Geoffrey K., Scholz, Barbara C. and Berlage, Eva. 2013. Anaphoric one and its implications. *Language* 89(4), 794–829.
- Pearl, Lisa and Lidz, Jeffrey. 2009. When domain-general learning fails and when it succeeds: Identifying the contribution of domain specificity. *Language Learning and Development* 5, 235–265.
- Penn, Gerald. 1999. A Generalized-Domain-Based Approach to Serbo-Croatian Second Position Clitic Placement. In *Constraints and Resources in Natural Language Syntax and Semantics*, pages 119–136, CSLI Publications.
- Pollard, Carl and Sag, Ivan A. 1994. *Head-driven Phrase Structure Grammar*. Chicago: University of Chicago Press.
- Pollard, Carl J. 1996. On Head Non-movement. In Bunt and van Horck (1996), pages 279–305.
- Press, Ian. 1986. *A Grammar of Modern Breton*. Berlin: Mouton de Gruyter.
- Reape, Mike. 1994. Domain Union and Word Order Variation in German. In Nerbonne et al. (1994), pages 151–197.

- Reape, Mike. 1996. Getting Things in Order. In Bunt and van Horck (1996), pages 209–254.
- Regier, Terry and Gahl, Susanne. 2004. Learning the unlearnable: The role of missing evidence. *Cognition* 93, 147–155.
- Reis, Marga. 1980. On justifying topological frames: “Positional field” and the order of nonverbal constituents in German. In Danièle Clément and B. Grunig (eds.), *Des Ordres en Linguistique*, pages 59–85, Paris: DRLAV.
- Reis, Marga. 1992. Zur Grammatik und Pragmatik von Echo-w-Fragen. In *Satz und Illokution*, Tübingen: Max Niemeyer Verlag.
- Sag, Ivan A. 1992. Taking Performance Seriously. In Carlos Martin-Vide (ed.), *VII Congreso de Lenguajes Naturales y Lenguajes Formales*, Barcelona.
- Sag, Ivan A. 2000. Another Argument Against Wh-Trace, Jorge Hankamer WebFest, <http://babel.ucsc.edu/Jorge/>.
- Sag, Ivan A. 2005. Adverb Extraction and Coordination: a reply to Levine. In Stefan Müller (ed.), *Proceedings of the HPSG 2005 Conference*, CSLI Publications.
- Sag, Ivan A. 2010. English Filler-Gap Constructions. *Language* 86(3), 486–545.
- Sag, Ivan A. 2012. Sign-Based Construction Grammar: An Informal Synopsis. In Boas and Sag (2012), pages 69–202.
- Sag, Ivan A., Boas, Hans C. and Kay, Paul. 2012. Introducing Sign-Based Construction Grammar. In Boas and Sag (2012), pages 1–29.
- Sag, Ivan A. and Wasow, Thomas. 2011. Performance-Compatible Competence Grammar. In Robert D. Borsley and Kersti B (eds.), *Non-Transformational Syntax: Formal and Explicit Models of Grammar*.
- Sag, Ivan A., Wasow, Thomas and Bender, Emily M. 2003. *Syntactic Theory: A Formal Introduction*. Stanford: CSLI Publications.

- Sato, Yo and Tam, Wai Lok. 2008. Towards a Unified Account of Adjuncts. In Stefan Müller (ed.), *Proceedings of the HPSG 2008 Conference*, pages 173–188, Stanford, CA: CSLI Publications.
- Steedman, Mark. 1991. Structure and Intonation. *Language* 67, 262–296.
- Steedman, Mark. 1996. *Surface Structure and Interpretation*. Linguistic Inquiry Monograph, No. 30, MIT Press.
- Steedman, Mark. 2000. Information Structure and the Syntax-phonology Interface. *Linguistic Inquiry* 34, 649–689.
- Steedman, Mark and Baldrige, Jason. 2011. *Combinatory Categorical Grammar*. pages 181–224, Wiley.
- Stephens, Janig. 2002. Breton. In Ball and Fife (2002), pages 349–409.
- Storto, Luciana R. 2003. Interactions between verb movement and agreement in Karitiana (Tupi stock). In *Revista Letras*, No. 60, pages 411–433, Curitiba: Editora UFPR.
- Tomasello, Michael. 2004. Syntax or semantics? A response to Lidz et al. *Cognition* 93, 139–140.
- Truckenbrodt, Hubert. 2006. On the semantic motivation of syntactic verb movement to C in German. *Theoretical Linguistics* 32(3), 257–306.
- Uszkoreit, Hans. 1987. *Word Order and Constituent Structure in German*. Stanford: CSLI Publications.
- van Gelderen, Véronique. 2003. *Scrambling Unscrambled*. Ph. D.thesis, University of Leiden.
- Wali, Kashi and Koul, Omkar N. 1997. *Kashmiri: A cognitive-descriptive grammar*. London/New York: Routledge.
- Weissberg, Josef. 1988. *Jiddisch: Eine Einführung*. Bern: Peter Lang.

- Wilder, Chris. 1997. Some Properties of Ellipsis in Coordination. In Artemis Alexiadou and T. Alan Hall (eds.), *Studies on Universal Grammar and Typological Variation*, Amsterdam: John Benjamins Publishing Company.
- Yatabe, Shûichi. 1996. Long-Distance Scrambling via Partial Compaction. In M. Koizumi (ed.), *Formal Approaches to Japanese Linguistics 2*, pages 303–317, Cambridge, MA.
- Yatabe, Shûichi. 2002. A Linearization-based Theory of Summative Agreement in Peripheral Node-raising Constructions. In Jong-Bok Kim and Stephen Wechsler (eds.), *Proceedings of the 9th International Conference on Head-driven Phrase Structure Grammar*, pages 391–411.
- Yngve, Victor H. 1960. A Model and a Hypothesis for Language Structure. *Proceedings of the American Philosophical Society* 104, 444–466.
- Zwicky, Arnold. 1986. Concatenation and Liberation. In Anne M. Farley et al (ed.), *Proceedings of the Twenty-Second Regional Meeting (General Session) of the Chicago Linguistics Society Chicago*, pages 65–74, Chicago Linguistics Society.