

Lessons from the English Auxiliary System¹

IVAN A. SAG†

Stanford University

RUI P. CHAVES

University at Buffalo, SUNY

ANNE ABEILLÉ

Université Paris Diderot–Paris 7

BRUNO ESTIGARRIBIA

University of North Carolina

DAN FLICKINGER

Stanford University

PAUL KAY

University of California, Berkeley

LAURA A. MICHAELIS

University of Colorado Boulder

STEFAN MÜLLER

Humboldt-Universität zu Berlin

GEOFFREY K. PULLUM

University of Edinburgh

FRANK VAN EYNDE

University of Leuven

THOMAS WASOW

Stanford University

[1] The primary author of this paper, Ivan Sag, worked on aspects of the auxiliary system of English throughout his career in linguistics. He left a version of this comprehensive overview

The English auxiliary system exhibits many lexical exceptions and subregularities, and considerable dialectal variation, all of which are frequently omitted from generative analyses and discussions. This paper presents a detailed, movement-free account of the English Auxiliary System within Sign-Based Construction Grammar (Sag 2010, Michaelis 2011, Boas & Sag 2012) that utilizes techniques of lexicalist and construction-based analysis. The resulting conception of linguistic knowledge involves constraints that license hierarchical structures directly (as in context-free grammar), rather than by appeal to mappings over such structures. This allows English auxiliaries to be modeled as a class of verbs whose behavior is governed by general and class-specific constraints. Central to this account is a novel use of the feature AUX, which is set both constructionally and lexically, allowing for a complex interplay between various grammatical constraints that captures a wide range of exceptional patterns, most notably the vexing distribution of unstressed *do*, and the fact that Ellipsis can interact with other aspects of the analysis to produce the feeding and blocking relations that are needed to generate the complex facts of EAS. The present approach, superior both descriptively and theoretically to existing transformational approaches, also serves to undermine views of the biology of language and acquisition such as Berwick et al. (2011), which are centered on mappings that manipulate hierarchical phrase structures in a structure-dependent fashion.

Keywords: Auxiliaries, English, Sign-based Construction Grammar, Syntax, Semantics

1. INTRODUCTION

English makes an important distinction between auxiliary and non-auxiliary phenomena. The data in (1) illustrate what have been referred to (see Quirk et al. (1985), Warner (1993)) as the NICE properties, or as NICER properties, once we factor in the ability of auxiliaries to be stressed or to combine with the particles

unfinished when he died in September 2013. His wish was that it should be finished and published as a co-authored journal article. The task of completion proved remarkably complex, and ultimately brought together a large cooperative team of his colleagues and friends — an outcome that would have greatly pleased him. A surprisingly large number of detailed problems had to be resolved by people well acquainted both with classical HPSG and the sign-based construction grammar (SBCG) that Ivan (with others) was developing over the last decade of his life. The order of names on the by-line of this paper reflects the various contributions to the work only imperfectly. The overall framework and content of the paper are entirely due to Sag; the vast majority of the rewriting was done by Chaves, who was in charge of the typescript throughout, and the other authors contributed by email in various ways to resolving the many problems that came up during the revision and refereeing. Ivan Sag acknowledged the financial support of the Andrew W. Mellon Foundation; the Alfred P. Sloan Foundation; The System Development Foundation; Stanford's Center for the Study of Language and Information; Das Bundesministerium für Bildung, Wissenschaft, Forschung, und Technologie (Project VERBMOBIL); grant no. IRI-9612682 from the National Science Foundation; and grant no. 2000-5633 from the William and Flora Hewlett Foundation to the Center for Advanced Study in the Behavioral Sciences. He expressed thanks to three anonymous *JL* reviewers of the first version he submitted to this journal, and to discussants including Farrell Ackerman, Emily Bender, Rajesh Bhatt, Bob Borsley, Joan Bresnan, Alex Clark, Ann Copestake, Bruno Estigarribia, Hana Filip, Chuck Fillmore, Dan Flickinger, Gerald Gazdar, Jonathan Ginzburg, Jane Grimshaw, Paul Hirschbühler, Dick Hudson, Paul Kay, Jongbok Kim, Paul Kiparsky, Tibor Kiss, Shalom Lappin, Bob Levine, Sally McConnell-Ginet, David Pesetsky, Carl Pollard, Eric Potsdam, Geoff Pullum, Peter Sells, Anthony Warner, Tom Wasow, and Arnold Zwicky. The co-authors of the present version wish to note the valuable assistance they had from Bob Borsley, Danièle Godard, and especially Bob Levine, plus three further *JL* reviewers of the final version.

too, so or *indeed* to perform a ‘rebuttal’ function (see, e.g. Jackendoff (1972) and Pullum & Zwicky (1997)).²

(1)

THE NICER PROPERTIES:

(Finite) Negation:	Lee will not eat apples / *Kim eats not apples.
Inversion:	Has Lee eaten apples? / *Eats Lee apples?
Contraction of <i>not</i> :	didn’t, shouldn’t / *eatn’t, *keptn’t,...
(Post-Auxiliary) Ellipsis:	Kim was/kept eating, and Lee was/*kept __, too.
Rebuttal:	Kim should/*tried <i>tóo/só</i> read it.

There are of course many other distinctive properties of the English Auxiliary System (EAS). One that to our knowledge remains unaccounted for in analyses of the EAS – including Hudson (1976a), Gazdar et al. (1982), Starosta (1985), Lasnik (1995), Kim & Sag (2002), Lasnik et al. (2000), and Freidin (2004) – is that auxiliary *do* is ‘necessary whenever it is possible’ (Grimshaw 1997). Thus, in a NICER construction, a finite nonauxiliary head is replaced by the corresponding form of auxiliary *do* and the base form of the head:

- (2) a. Kim does not eat apples.
 (*Kim eats not apples.)
 b. Does Lee eat apples?
 (*Eats Lee apples?)
 c. Kim didn’t eat apples.
 (*Kim aten’t apples.)

The EAS is also special in that it has played a pivotal role in shaping linguistic theory. Chomsky’s (1957) analysis of EAS in *Syntactic Structures*, a variant of earlier treatments in Chomsky (1955, 1956), argued that EAS must be analyzed in terms of movement operations like those whose effect is sketched in (3).³

(3) Subject-Auxiliary Inversion (aka ‘SAI’, T_Q)

- a. [Kim [s have en be ing eat beans]]. ⇒
 b. [s have Kim [en be ing eat beans]]. ⇒

The existence of discontinuous dependencies such as these (e.g. between *have* and *en*) was taken to motivate a framework based on transformational

[2] This mnemonic was coined by Huddleston (1976). For a slightly different classification, and an overview of the grammatically relevant properties of auxiliaries, see Huddleston, Pullum et al. 2002, pp. 90–115. Following Miller & Pullum (2013), we use the term Post-Auxiliary Ellipsis (PAE) rather than the more familiar ‘VP Ellipsis’ because, as Hankamer (1978: 66n) notes, it is neither necessary nor sufficient that it should involve ellipsis of a VP. We also take the position that infinitival *to* is an auxiliary verb, as assumed by GPSG and argued for by Levin (2012).

[3] *en* is the perfect participle suffix, *ing* the present participle suffix, and *s* the 3rd-singular-indicative present verbal inflection.

operations (movement rules), an assumption that has persisted until now (Berwick & Chomsky 2008, Berwick et al. 2011), even though it has been quite widely challenged.⁴ Crucially, the movement-based analysis of EAS also permeated discussions of broader issues, such as debates about learnability. For example, in Piattelli-Palmarini (1980: 40) Chomsky argues that although children make many errors during language learning, they do not produce errors such as **Is the man who here is tall?*, where the auxiliary in the relative clause is fronted rather than the auxiliary in the main verb phrase, i.e. *Is the man who is here tall?* The experimental results in this domain like those of Crain & Nakayama (1987) suggested that subjects interpret sentences like (3a) as (3b), not (3c).

- (4) a. Can eagles that fly eat?
 b. = Is it the case that eagles that fly can eat?
 c. ≠ Is it the case that eagles that can fly eat?

Ambridge et al. (2008) note several design flaws in Crain's experiments, and describe two elicited production studies which revealed that children occasionally do produce the supposedly non-existent type of sentences. In forming polar interrogatives of sentences with two instances of 'can', around 20% of children's responses involved either doubling the auxiliary (*Can the boys who can run fast can jump high?*) or exactly the type of error that Chomsky claimed never occurs, e.g. *Can the boy who run fast can jump high?* The results were similar with sentences involving two occurrences of 'is' (*Is the boy who washing the elephant is tired?*). Ambridge et al.'s conclusion is that the "data do not provide any support for the claim that structure dependence is an innate constraint, and that it is possible that children form a structure-dependent grammar on the basis of exposure to input that exhibits this property".

Moreover, as Bob Borsley (p.c.) notes, the example in (4a) is particularly unhelpful because modals like *can* show no agreement and because the non-finite form of a regular verb is identical to the non-third person singular present tense form. If all examples were as unhelpful as this there might really be a Poverty of the Stimulus issue, but they are not. Berwick and Chomsky's example becomes more helpful if *eagles* is replaced by *an eagle*, i.e. *Can an eagle that flies eat?* Here it is clear that *can* is associated with *eat* and not *flies* because the latter can only be a third person singular present tense form. In fact, all the child has to learn is that a clause-initial auxiliary is followed by its subject and its complement, and there is plenty of evidence for this, specially when the auxiliary agrees with the subject, as in *Has/*Have Kim gone home?*, *Have/*Has the boys gone home?*, *Is/*are Kim going home?*, etc. Whatever grammatical

[4] Indeed, the widespread acceptance of Chomsky's analysis of EAS, extolled by Lees (1957) as the first truly 'scientific' analysis of a significant syntactic problem, had immediate and profound consequences for the field. But as Gazdar et al. (1982: 613–616) showed, Chomsky's analysis suffered from a host of problems, including various ordering paradoxes and counterintuitive constituency claims.

approach is assumed, it is clear that from simple examples a learner can note that polar interrogatives involve an auxiliary followed by its subject and its complement. Once the learner knows this she will have no problems from more complex examples. In other words, whether or not learners encounter auxiliary-initial clauses with subjects containing a relative clause is unimportant. They can learn the key properties of auxiliary-initial clauses from simple examples and will have no problem with more complex examples whether or not they have encountered them. Indeed, a range of computational modeling results suggest that SAI can be learned from the data alone, such as Lewis & Elman (2001), Reali & Christiansen (2005), Clark & Eyraud (2006), and Bod (2009). For more discussion see also Estigarribia (2007: 14–16), Pullum & Scholz (2002), Scholz & Pullum (2006) and Clark & Lappin (2011: ch.2). In response to such recent positive learnability results for various classes of CFGs (Context-Free Grammars), Berwick & Chomsky (2008: 383) write that ‘such work does not even address the AFP [auxiliary fronting problem] as originally posed, since the original formulation employs the notion ‘front’, i.e., ‘move’, not a part of the CFGs or alternatives used in these recent challenges.’ This is the weak link in the argument. Even if we all agree that grammars for human languages have no transformations whose structural analysis requires counting the number of auxiliaries, we need not *ipso facto* believe that such grammars have structure-sensitive transformations. Several traditions of nontransformational grammar are well established in the field, including Categorical Grammar (Steedman 1996, 2000), Head-Driven Phrase Structure Grammar (Pollard & Sag 1994, Ginzburg & Sag 2000), Lexical-Functional Grammar (Bresnan 2001) and not one of these is even mentioned in recent discussions of EAS, even though the literature contains several comprehensive and reasonably precise analyses, published in highly accessible venues.

Chomsky claims that syntactic knowledge consists in large part of a transformational mapping from phrase structures to phrase structures (what is now referred to as ‘Internal Merge’). But if grammatical rules directly generate linguistic structures without any transformational mappings, then ‘what people know’ about EAS includes no fronting rules, and the entire issue of whether or not transformations make reference to phrase structure is rendered moot.

In this paper, we present a new, nontransformational analysis of EAS, show that it answers the various concerns that have been raised in the half century of extensive research on this topic. Moreover, we show that it handles idiosyncrasies never properly treated (to our knowledge) in transformational terms, arguing that this analysis is a plausible candidate for ‘what people know’ about EAS. As we will see, this analysis has no ‘structure-dependent operations’. As a corollary, Chomsky’s famous argument for the Poverty of the Stimulus based on EAS collapses. The structure of the paper is as follows. Section 2 provides a brief and non-technical exposition of the account. Section 3 we presents the theoretical framework in detail, and lays out the basic foundations of the grammar. Finally, the next sections focus on the EAS, and in particular, with Inversion, Ellipsis,

Negation, and Rebuttal, respectively.

2. TOWARDS A CONSTRUCTIONAL ANALYSIS

Despite the success of constraint-based, lexicalist frameworks (including Hudson (1976b), Gazdar et al. (1982), Warner (2000), and Kim & Sag (2002)) in analyzing the lexical idiosyncrasy that surrounds such matters as inversion, negation, and contraction, the fact remains that all such accounts have failed to provide a satisfactory account of the restricted distribution of unstressed *do*, i.e. the famous contrast between pairs like (5a,b):

- (5) a. *Kim *did* leave.
b. Kim *did* leave.

It is sometimes thought^[5] that such contrasts can be explained in pragmatic terms. For example, one might try to explain the deviance of (5a) as pragmatic preemption, given the availability of the synonymous (6):

- (6) Kim left.

Such an account would presumably appeal to Grice's (1975) maxims of Quantity ('Be brief') and/or Manner ('Avoid Prolivity'). Falk (1984) instead assumes that (6) preempts (5a) by a grammatical principle equivalent to the principle of Economy of Expression discussed in Bresnan (2000). Freidin (2004) makes a similar proposal in terms of his principle of 'Morphological Economy'. In all such accounts, (5b) is meant to avoid preemption because some further meaning is being conveyed that (6) cannot express.^[6] According to Economy of Expression, syntactically more complex sentences are preempted by the availability of syntactically less complex sentences that are semantically (or functionally) equivalent. Morphology thus competes with, and systematically blocks, syntax.

The trouble with such explanations is that they explain too much. First of all, they seem to leave no room for dialects of the sort reported by Palmer (1965) (see Klemola (1998) and Schütze (2004) for further discussion), where examples like (5a) are apparently fully grammatical and completely synonymous with (6). In addition, the competition-based approach would lead us to expect, incorrectly, that examples like the following should also be preempted:

- (7) a. We thought they would (cf. they'd) accept our offer.
b. I will not (cf. won't) put up with this.

Similarly, optional ellipsis, as in the following sentences, should not be possible:

[5] See, for example, Kim (2000).

[6] In order for this analysis to succeed, it would of course also have to explain why (i) does not preempt (5b):

(i) Kim *léft*.

- (8) a. I know (that) she's right.
 b. Pat prefers (for) them to go first.
 c. The Red Cross helped them (to) get back on their feet.
 d. Kim went to the store before Sandy went to the store
 (cf. ...before Sandy did _ .)
 e. They're more likely to go to Paris than they are to go to Rome.
 (cf. They're more likely to go to Paris than (to) Rome).

These are worrisome incorrect predictions that preemption-based theories are hard-pressed to avoid. One might try to correct this problem by resorting to distinctions of finer grain, but it is difficult to find independent motivation for a semantic or functional distinction between contracted and uncontracted forms, between embedded clauses with or without *that*, or between deaccented and elided expressions (for example) [7]. In any case, an analysis along these lines would have to explain why (5a) is not semantically/functionally distinct from (6), since otherwise the preemption-based explanation for (5a) would be undermined. The contrast between (5a,b) appears to be the kind of problem that should be accounted for not by general principles of preemption, but rather by the particulars of the grammar of English.

In the remainder of this section we present a preliminary informal version of the analysis detailed later in the paper, along with some of the basic facts that motivate key elements of the analysis. Some aspects of this account may be familiar from earlier non-transformational analyses, but there are crucial innovations, which we will highlight. Central to the present account of the English auxiliary system is the distinction between **auxiliary verbs** and **auxiliary constructions**. The latter are just the NICER environments, and they all require verbal daughters that bear the feature AUX+. Some of these environments are modeled with lexical constructions (i.e. constructions that apply to AUX+ verbs) others are modeled with phrasal constructions (i.e. constructions where the head daughter is required to be AUX+). Conversely, auxiliary verbs are just those verbs that can take the value “+” for the feature AUX. But unlike previous non-transformational accounts, ours does not treat most auxiliary verbs as intrinsically AUX+; rather, the feature AUX is left lexically unspecified for (most of) these verbs and is resolved as ‘-’ or ‘+’ constructionally. Non-auxiliary verbs, on the other hand, do have the lexical specification AUX-. Hence, only auxiliary verbs occur in the NICER environments, but the converse does not hold; that is, (most) auxiliary verbs can appear in non-auxiliary constructions. For example, an auxiliary verb like *could* is allowed in a non-auxiliary construction like (9a), but a non-auxiliary verb like *help* may not occur in an auxiliary construction as (9b) illustrates.

- (9) a. Sandy could/helped finish the job.
 b. Sandy could/*helped not finish the job.

[7] See [Walter & Jaeger \(2005\)](#) and [Jaeger & Wasow \(2005\)](#) for further discussion.

There is, however, (at least) one verb that is lexically marked AUX+. That is the auxiliary *do*. This fact accounts for a critical distributional difference between *do* and modal verbs, namely, that the latter but not the former occurs as the head of a simple, non-negative declarative without heavy stress, a paradigmatic AUX– environment.

- (10) a. *Kim did leave.
b. Kim will leave.

Because it is lexically AUX+, the auxiliary *do* is only consistent with the NICER constructions. Crucially, notice that it is the **construction**, not the semantic/pragmatic **function** that determines what environments take AUX+ verbs. Thus *Is Pat ever dishonest* requires an AUX+ verb (cf. **Seems Pat ever dishonest*) whether used as a question or as an exclamation, and *Lee saw you?* can be used as a question (with appropriate prosody), with an AUX– verb, because it does not involve the inversion construction.

A second feature, INV, signals whether the auxiliary precedes the subject. Thus, in *Is Sam happy?* the verb is specified as INV+, and in *Sam is happy?* the verb is specified as INV–. Like the feature AUX, INV is generally lexically underspecified on auxiliary verbs. The value of these features in any particular use of an auxiliary verb is determined by the constructions it occurs in. One exception to this lexical underspecification of INV is the first-person singular use of *aren't*, as in *Aren't I invited?* (cf. **I aren't invited*). Hence, the latter verb use is necessarily INV+, and consequently can only appear in inversion constructions. For many speakers, the deontic use of *shall* is also limited to inverted environments, as illustrated by contrasts like the following, originally due to Emonds, as cited by Chomsky (1981: 209) [8]

- (11) a. We shall dance.
b. Shall we dance?

Here there is a semantic difference between the auxiliary verb *shall* in (11a) and the one in (11b): the former conveys simple futurity whereas the latter has a deontic sense. This is similarly accounted for by marking deontic *shall* as INV+.

Finally, the grammar must prevent auxiliary verbs like *do* and *be* from combining with VPs headed by a grammatical verb as (12) and (13) illustrate. We use the feature GRAM in order to distinguish the grammatical verbs (*be*, *have*, and *do* in our grammar) from all others. Whereas the former are lexically specified as GRAM+, all others are GRAM–.

- (12) a. Will / Would / *Did / *Was Chris be fired?
b. Would / *Did Chris have seen the movie?
(13) a. Was Chris fired?
b. *Was Chris been fired?

[8] Note, however, that there is considerable dialectal variation regarding *shall* (Nunberg 2001).

Thus, the ungrammatical examples in (12) can be ruled out by requiring that the complement of auxiliary *do* and auxiliary *be* must be GRAM-⁹

The constructional rules of the grammar (lexical or phrasal) can impose particular constraints on AUX, INV and GRAM. Thus, the construction rule for **non-inverted clauses** requires that the head VP be specified as AUX- and INV- and that it precedes its complements. Most verbs can in principle head a VP, auxiliary or not, with the exception of verbs that are obligatorily AUX+ such as unstressed *do*, or verbs that are obligatorily INV+ such as first-person *aren't* and deontic *shall*. Hence, we license VPs like *read a book, can sing, will win*, etc. However, some auxiliary verbs like the modal *better* are lexically specified as INV-, and therefore are only compatible with non-inversion constructions:

- (14) a. We better be careful.
b.*Better we be careful?

The rules for the NICER constructions all stipulate that the verbal daughter must be resolved as AUX+. This prevents non-auxiliary verbs, which are lexically AUX-, from appearing in any of these environments. For example, the construction rule for **Inversion** requires the auxiliary verb to precede all of its arguments. This rule interacts with other NICER constructions to license a range of different valence patterns, such as *Do you sing?*, *Do you not sing?*, *Do you?*, or *Boy, did I like your singing!*

The **Post-Auxiliary Ellipsis** construction, in contrast, is lexical, and applies only to AUX+ verbs in order to suppress the most oblique complement. More specifically, the PAE rule takes an AUX+ verb that selects a subject and a complement, and licenses a counterpart of this verb that no longer subcategorizes for the complement. The semantics of the missing phrase is anaphorically recovered from the semantic context of the utterance; see Ginzburg & Sag (2000), Jacobson (2008), Culicover & Jackendoff (2005), and Miller & Pullum (2013), thus predicting that ellipsis need not have overt antecedents, and its immunity to island constraints, among other things. By requiring that the 'input' verb be specified as AUX+, this rule crucially limits the verbs that can appear in the construction to auxiliaries, accounting for contrasts like (15).

- (15) a. They aren't angry with us, even though they seem to be.
b.*They aren't angry with us, even though they seem.

The PAE rule licenses verbs with an underspecified AUX feature, in order to account for the fact that auxiliaries with elided complements are not restricted to NICER environments. Thus, even unstressed *do* – normally barred from appearing in non-inverted, non-negated clauses – can now do so, e.g. *Robin did / didn't*. The underspecification of AUX on the higher node makes ellipsis generally possible in

[9] In Gazdar et al. (1982) and other accounts, such effects were controlled by AUX instead, but in the present account AUX is not strictly lexically specified.

non-inverted, non-negated environments, as in *Robin will*, as long as the verb is an auxiliary.

The **Negation** construction is also lexical, and similarly requires an AUX+ verb, but instead of removing an argument from the verb's argument structure, it adds a clausal negator to it. Thus, AUX- verbs are not compatible with clausal negation (e.g. **Kim gets not hungry*). Moreover, as in the case of PAE, the 'output' verb is underspecified for AUX, allowing negated verbs to appear in otherwise simple declarative environments (e.g. *Kim is not hungry*), including unstressed *do*. Thus, whereas **Robin did sing* is not acceptable, its negative counterpart *Robin did not sing* is. As we shall see, the scope of sentential negation varies with the choice of auxiliary, and therefore two distinct rules will be necessary to account for the syntax and semantics of clausal negation. For example, *not* outscopes *can* in *Chris cannot accept that* but is outscoped by deontic modals like *may* or *might* as in *They might not like the wine*.

Contraction is also accounted for by lexical rule which applies to words resulting from the Negation rule (that is, words with NOT as a complement). The rule removes *not* from the argument structure, computes the contraction form (if none exists, the rule is undefined and therefore cannot successfully apply), and combines the verbal semantics with the negation. As with the other lexical rules, AUX is underspecified in the mother node and therefore contracted forms may appear in non-NICER environments, e.g. *Robin didn't sing*.

Finally, the **Rebuttal** construction is a lexical rule requiring an AUX+ verb with a finite verb form. The rule adds the rebuttal semantics, adds phonological material, and yields a verb that is required to head an independent clause ^[10]. Hence, rebuttal cannot occur with non-auxiliary verbs, as in **Kim read too that book*, and because AUX is underspecified in the 'output' of the rule, the rebuttal form may appear in non-inverted environments, e.g. *Kim did too leave*.

There are a number of other phenomena that the present account can capture, and a number of details that the above informal discussion has omitted. We now turn to a more detailed exposition of our constructional account.

3. SIGN-BASED CONSTRUCTION GRAMMAR

Although the analysis of EAS presented here is in principle compatible with a number of grammatical frameworks, it is particularly well expressed in Sign-Based Construction Grammar (SBCG) ^[11] the synthesis of Berkeley Construction

[10] The feature I(NDEPENDENT)-C(LAUSE) from Ginzburg & Sag (2000) is used to ensure that the phrase licensed by this verb cannot function as a subordinate clause, except in those environments where 'main clause phenomena' are permitted.

[11] Boas & Sag (2012), Michaelis (2011), Sag (2010).

Grammar^[12] and Head-Driven Phrase Structure Grammar^[13] developed by Fillmore, Kay, Michaelis, Sag, together with various colleagues and students. As argued by Johnson & Lappin (1999), there are certain kinds of cross-linguistic generalizations that are difficult to state in a grammar lacking the notion of ‘construction’. Not all syntactic facts can be attributed to the properties of individual lexical items or very general combinatorial mechanisms, as assumed both in the Chomskyan mainstream and early HPSG. We argue that the EAS is one such example. Moreover, SBCG exhibits a number of important design properties that make it an attractive choice for psycholinguistic modeling. SBCG embodies Bresnan and Kaplan’s (1982) Strong Competence Hypothesis, in that it fits naturally in a processing regime where partial meanings are constructed incrementally (Tanenhaus et al. 1995, Sag & Wasow 2015). SBCG thus helps make sense of Fodor et al. (1974:276)’s conclusions that linguistic representations are cognitively confirmed, but not the transformational processes that were supposed to relate them.^[14]

3.1. Analytic Preliminaries

In the theory of Construction Grammar we present here (SBCG; see Boas & Sag (2012)), **words** and **phrases** are modeled as **signs**. The latter is a type of feature structure reflecting a correspondence of sound, morphology, syntactic category, meaning, and/or contextual conditions. A sign thus specifies values for the features PHONOLOGY (PHON), (morphological) FORM, SYNTAX (SYN), SEMANTICS (SEM), and CONTEXT (CNTXT), as illustrated in the verbal sign schematically depicted in Figure 1. The feature CAT contains information about part of speech, verb form (finite, infinitival, base, etc.), inversion (+/–), auxiliary (+/–), and valence (as a list of signs).

The Attribute-Value Matrix (AVM) format seen in Figure 1 corresponds to a function that maps each of the features to an appropriate domain, specified by the grammar. Since the domain of functions of type *sign* is the set {PHON, FORM, SYN, SEM, CNTXT}, each particular sign maps each element of this domain to a different, appropriate type of complex value, i.e. another functional feature structure. The values of the feature SYN (SYNTAX) are feature structures specifying values for CATEGORY (CAT) and VALENCE (VAL), and categories are feature structure complexes, similar to those used in \bar{X} -Theory (see Appendix for more details). We are simplifying morphology by describing FORM values in terms of a sequence of orthographic representations, and the semantics used here

[12] Fillmore et al. (1988), Michaelis & Lambrecht (1996), Kay & Fillmore (1999), Michaelis & Ruppenhofer (2001).

[13] Pollard & Sag (1994), Ginzburg & Sag (2000).

[14] Feature-based phrase structure grammars like SBCG can be associated with weights (Brew 1995, Briscoe & Copestake 1999, Linadark 2006, Miyao & Tsujii 2008) and integrated into psycholinguistic models where the effects of frequency, priming, and inhibition can be taken into account (Konieczny 1996).

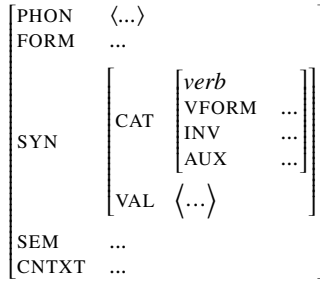
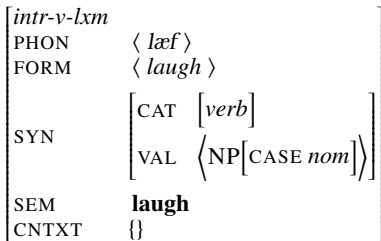

Figure 1
The geometry of verbal signs (schematic)

is also simplified in ways which we will explain in due course.

The feature VAL(ENCE) lists arguments that are overtly and locally realized in syntax. Thus, (I6) corresponds to a use of the lexeme *laugh* where the subject is overt and local, rather than extracted (e.g. *It was Tim who I think laughed*) or elided (e.g. *(He) laughed all day long yesterday... or Laugh!*)^[15]

(16) **An intransitive verbal lexeme**



Lexemes are organized into a type hierarchy by the grammar signature (see the Appendix), thus allowing details of a verb to be determined by inference (the ‘logic of the lexicon’), rather than by separate stipulation for each lexical item. The lexeme hierarchy allows cross-cutting generalizations to be expressed. The hierarchy of verbal lexemes, for example, is illustrated in part in Figure 2. We use *lxm* to abbreviate *lexeme*, and *aux* to abbreviate *auxiliary*. The type of the sign in (I6) is *intr(ansitive)-v(erb)*, but other types are possible. For example, the same verb can alternatively be used as a transitive verb (e.g. *Robin laughed the lyrics rather than singing them*), in which case it will be typed as *trans-v-lxm* and as a consequence, have two valents. The same goes for all other uses of the verb, including resultatives (e.g. *Robin laughed the kids off the stage* or *Robin laughed*

[15] Whereas the feature VAL characterizes the overt syntactic realization of the valents (i.e. whether they are local or extracted, elliptical or not), the feature ARG(UMENT)-STR(UCTURE) is responsible for establishing the size and type of valence frame of any given word, regardless of their overt realization. However, for our purposes all constraints are stated over VAL, and ARG(UMENT)-STR(UCTURE) is not shown, since nothing hinges on this distinction here.

herself to tears), cognates (e.g. *Sam laughed her maniacal laugh*) directed path constructions (e.g. *Sam laughed her way out of the room*), to list but a few.

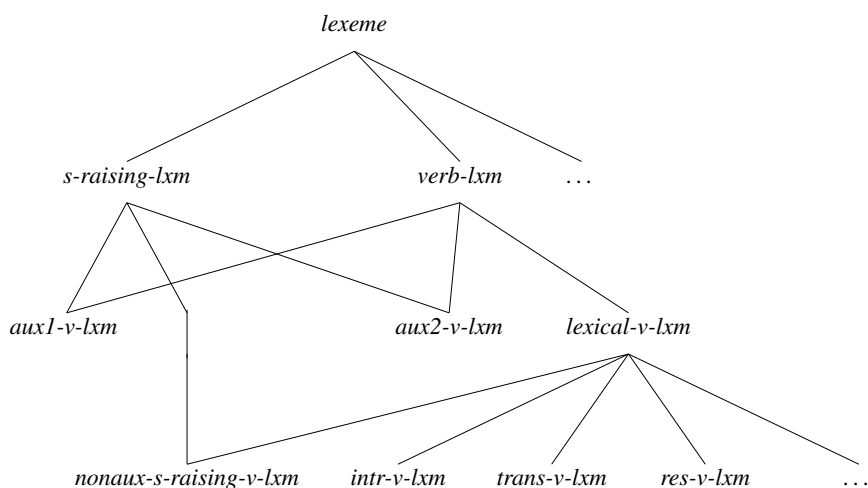

Figure 2
A partial view of the English lexeme hierarchy

In this type hierarchy there is a high-level dichotomy between transitive and intransitive verbal lexemes that is orthogonal to the distinction drawn between lexical verbs and others. This allows us to establish multiple lexical classes, e.g. *aux1-verb-lexeme* (*aux1-v-lxm*) and *nonaux-subject-raising-verb-lexeme* (*nonaux-subject-raising-v-lxm*) – each of whose members have distinct class-based properties in addition to those that they all share in virtue of the common supertype *subject-raising-verb-lexeme* (*s-raising-v-lxm*). Note that the hierarchy in Figure 2 is somewhat simplified in that auxiliary verbs like equative *be* (e.g. *This is Kim*) are arguably not raising verbs; see Mikkelsen (2002) and Eynde (2015) for further discussion. The basis for partitioning the auxiliary verbs into two classes is discussed in sec. 6 below.¹⁶

[16] Falk (2003) argues that auxiliaries like *dare not* are not a raising verb either, but attestations like (i) and (ii) indicate otherwise. Regardless, the present account can be revised by introducing new supertype covering subject-raising, control and equative verbs, allowing for some auxiliary verb to be raising and others control.

- (i) It has been said of the precautionary principle that its underlying principle is: There dare not be even a risk of a risk. Almost every human activity – from (...) [17-10-16 USWashington Examiner ABC]
- (ii) Cleaning a meth house can be expensive \$3,000 to \$4,000 or more, and there dare not be a speck of the drug left behind. (<http://www.methproject.org/action/details/news-story-2014-04-12.html>)

Each lexical class is defined in terms of a lexical-class construction – an implicational constraint specifying the characteristic properties of its members [17]. For example, all lexemes of the type *verb-lxm* are required to have part-of-speech *verb* and exactly one external argument (the subject), as per the constraint in (17a). In this work, we assume that SBCG constraints are stated as an implicational relation of the form ‘ $\tau \Rightarrow C$ ’, which states that ‘all feature structures of type τ must satisfy the condition C ’ (where C is a feature structure description) [18]. Similarly, all lexemes of the type *lexical-v-lxm* are required to be AUX–, INV– and GRAM– as per (17b), and all lexemes of the type *s-raising-v-lxm* must have two arguments, the first of which is also the first argument of the second argument, as (17c) shows. Finally, (17d) requires lexemes typed as *intr-v-lxm* to have exactly one valent in their VAL list, and analogously, all the other types in Figure 2 impose constraints of varying degree of granularity on the lexemes they subsume.

- (17) a. $verb-lxm \Rightarrow \left[\text{SYN} \left[\begin{array}{l} \text{CAT } verb \\ \text{VAL } \langle X, \dots \rangle \end{array} \right] \right]$
- b. $lexical-v-lxm \Rightarrow \left[\text{SYN} \left[\text{CAT} \left[\begin{array}{l} \text{AUX} \quad - \\ \text{INV} \quad - \\ \text{GRAM} \quad - \end{array} \right] \right] \right]$
- c. $s-raising-v-lxm \Rightarrow \left[\text{VAL} \left(\langle X, [\text{VAL } \langle X \rangle] \rangle \right) \right]$
- d. $intr-v-lxm \Rightarrow \left[\text{VAL } \langle X \rangle \right]$

Signs of type *word* are in turn obtained by the combination of a lexeme explicitly listed in the lexicon and the appropriate constructions. Hence, the lexeme in (16) interacts with inflectional constructions to license a sign of type *word*, like the following (18). Whereas constructions are constraints on classes of signs and on their components, the objects described/licensed by the grammar are *constructs* and are displayed inside a box.

[17] For a more detailed discussion, see Sag (2012).

[18] Variables such as X range over feature structures in the constructions and constraints we formulate.

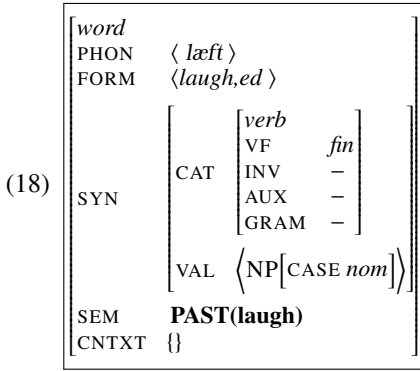

Feature structures are also used to describe complex structures, conveying exactly the same information as more familiar local trees, as illustrated in (19). Such representations correspond to a function mapping the feature MOTHER (MTR) to a sign and the feature DAUGHTERS (DTRS) to a list of signs.

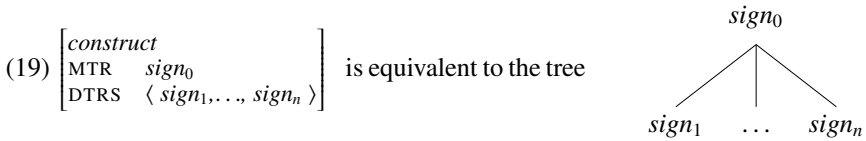

An instance of a local construction is sketched in Figure 3 in this case, involving two daughters, one nominal, the other verbal. Throughout this work, the symbols ‘S’, ‘NP’ and ‘VP’ are used as abbreviations. More specifically, ‘S’ corresponds to any AVM bearing the features [CAT *verb*] and [VAL ⟨ ⟩], ‘VP’ corresponds to any AVM bearing the features [CAT *verb*], [INV -], and [VAL ⟨XP⟩], and so on. From now on we will omit the PHON feature, for simplification.

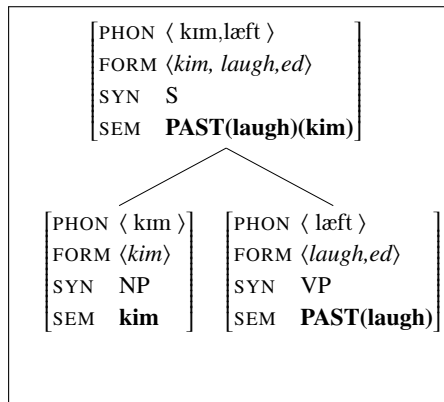
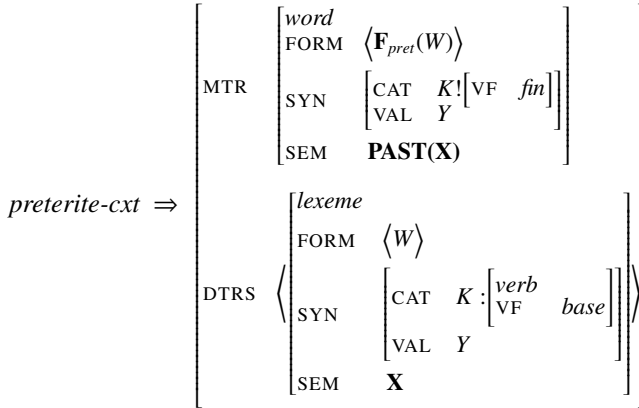

Figure 3
A local phrasal Construct (abbreviated)

Constructions can be unary-branching, and require signs of particular types. For example, the preterite construction shown in (20) applies to any sign of (sub)type *lexeme* to yield a tensed and inflected counterpart of type *word*.^[19] We use the notation ‘[FEAT1 X![FEAT2]]’ to indicate that the feature FEAT1’s value must be identical to the feature structure tagged as *X* elsewhere in the diagram, except with respect to the value of feature FEAT2. We use *cxt* as an abbreviation for *construct*.

(20) **Preterite Construction** (\uparrow *inflectional-cxt*)



Hence, (20) requires that the CAT value of the daughter be identical to the mother except for the value of VF which in the daughter is required to be base form (*base*) and in the mother is required to be finite (*fin*).^[20] Finally, the \mathbf{F}_{pret} function computes the preterite form of *W*. If none exists, the construction cannot apply simply because there is no output for that input. Hence, whereas most verbs are in the domain of the function, including auxiliaries like $\mathbf{F}_{\text{pret}}(\textit{do}) = \textit{did}$, others like $\mathbf{F}_{\text{pret}}(\textit{can})$ are undefined and therefore no preterit use of the latter exists.

The semantics requires some explanation. For convenience, we are assuming a ‘Montague-style’ semantics for clauses and other expressions. For example, a proposition-denoting expression is built up in ‘Schönfinkel form’, where the

[19] We indicate via \uparrow the names of immediately superordinate types, which provide constructional constraints of immediate relevance. This is purely for the reader’s convenience, as this information follows from the type hierarchy specified in the grammar signature. See the Appendix for a summary of the type hierarchy and the relevant constructions. In the case of (20), the annotation \uparrow *inflectional-cxt* indicates that (20) is a sub-type of inflectional construction, which imposes further constraints on MTR and DTRS. This in turn means that the types *lexeme* and *word* can in fact be omitted from (20), as they are one of the general requirements imposed by the *inflectional-cxt* superordinate.

[20] We thus provide a natural way of expressing linguistically natural constraints requiring that two elements must be identical in all but a few specifiable respects. Note that this is a purely monotonic use of default constraints, akin to the category restriction operation introduced by Gazdar et al. (1985). Constructions of this kind are equivalent to what some people refer to as ‘lexical rules’, notably in terms of their interactions. For discussion, see Müller (2006, 2007), Sag (2012), and Müller & Wechsler (2014).

verb's semantics combines with one argument at a time – e.g. first the direct object, then the subject. ‘ $\mathbf{Y(X)}$ ’ is in fact an instantiation of the more general schema ‘ $FR_{\tau}(\{\mathbf{Y,X}\})$ ’ (the functional realization (of type τ) of the multiset Σ_{ms} defined as follows (see Klein & Sag (1985) and Gazdar et al. (1985)).

(21) Functional Realization

- i. If (1) τ is a logical type and (2) Σ_{ms} is a multiset consisting of typed logical expressions $\sigma_1, \dots, \sigma_n$, then $FR_{\tau}(\sigma_1, \dots, \sigma_n)$ is a schema denoting a set of logical expressions of type τ that are derived by applying some σ_i to some σ_k , then applying the result to some σ_m , and so forth, until each member of Σ_{ms} has been ‘consumed’ exactly once in the construction of FR_{τ} .
- ii. The denotation of FR_{τ} may be empty (there may be no possible functional realization of the expressions in question).
- v. The denotation of FR_{τ} may contain more than one logical expression (there may be multiple functional realizations of the expressions in question.)

A SBCG thus defines a set of structures, each of which is grounded in lexical signs and which can be represented as a tree, much like the tree structures of a context-free grammar. However, the labels on the nodes of these trees are not atomic category names (NP, S, V, etc.), but rather feature structures of type *sign*, similar to the practice of frameworks like Categorical Grammar and Generalized Phrase Structure Grammar, and most contemporary work in syntax. And as in declarative reconceptualizations of phrase-structure rules like McCawley (1968), SBCG constructions are static constraints that license local structures. Take for instance the Subject-Predicate Clause constructions, which correspond to the most common type of clausal construct in English: simple declarative clauses like (22a), present subjunctive clauses like (22b), imperative-like clauses with subjects, like (22c), and so on.^[21]

- (22) a. {[Sandy] [leaves me alone]}.
- b. I insist (that) {[Sandy] [leave me alone]}.
- c. {[You]/[Everyone] [leave me alone]}!
- d. I intended (for) {[him] [to leave you alone]}.

Such examples are all accounted for by the Subject-Predicate Construction in (23), which belongs to two distinct constructional classes, one pertaining to headedness (a subject-head combination) and the other pertaining to clausality (a declarative clause), an important aspect which we return to shortly.

[21] The informal representation in (22) is due to Chuck Fillmore. According to this scheme, a daughter is represented simply by enclosing its word sequence in square brackets; a construct is indicated by enclosing its sequence of daughters in curly braces.

(23) **Subject-Predicate Construction** (\uparrow *subject-head-cxt* & \uparrow *declarative-cl*):

$$\text{subj-pred-cl} \Rightarrow \left[\begin{array}{l} \text{MTR} \left[\begin{array}{l} \textit{phrase} \\ \text{SYN} \left[\begin{array}{l} \text{CAT} \ H \\ \text{VAL} \ \langle \rangle \end{array} \right] \\ \text{SEM} \ \mathbf{Y}(\mathbf{X}) \end{array} \right] \\ \text{DTRS} \left\langle Z : [\text{SEM} \ \mathbf{X}] , \left[\begin{array}{l} \text{SYN} \left[\begin{array}{l} \text{CAT} \ H : \left[\begin{array}{l} \text{VF} \ \textit{fin} \\ \text{AUX} \ - \\ \text{INV} \ - \end{array} \right] \\ \text{VAL} \ \langle Z \rangle \end{array} \right] \\ \text{SEM} \ \mathbf{Y} \end{array} \right] \right\rangle \end{array} \right.$$

This construction requires that the second daughter bears *AUX-*, *INV-*, and *VFfin* specifications, which ensure that the head must be a finite verbal phrase. In general, the colon indicates that the immediately following constraint must be satisfied by all values of the immediately preceding variable. Thus, the *H* variable in (23) requires that the mother’s *CAT* value be identical to the second daughter’s *CAT* value (effectively stating that the second daughter is the head of the construction) and the *Z* variable has the effect that the valent subcategorized by the head daughter via *VAL* be identified with the first daughter *Z*. Finally, the semantics of the head takes as argument the semantics of the subject.^[22] Thus, a sentence like the one in Figure 4 is licensed by applying the construction in (23) to the sign for *Tim* and the sign for *laughed*. The presence of the tag ‘1’ indicates that the sign in the *VAL* list has in fact been identified with the first daughter’s, as required by (23).^[23] Agreement information is not shown, for simplification, and phonological composition rules are omitted. For convenience, we have also omitted discussion of linear ordering, by assuming that the order of elements on the DTRS list determines the order of elements on the mother’s FORM list.^[24]

Let us now return to the fact that (23) belongs to two distinct constructional classes, one phrasal and one clausal, as seen in Figure 5. Following Ginzburg & Sag (2000), we assume that there are a number of similar Subject-Head constructions, including the one responsible for ‘Mad Magazine’ sentences

[22] For a more streamlined version of this and other constructions see Sag (2012).

[23] Here and throughout, boxed numbers or letters (‘tags’ in the terminology of Shieber (1986)) are used to indicate pieces of a feature structure that are equated by some grammatical constraint. However, the linguistic models assumed here are simply functions, rather than the reentrant graphs that are commonly used within HPSG. For an accessible introduction to the tools employed here, see Sag et al. (2003).

[24] See Sag (2012) for more details. At stake is a complex set of issues that have motivated the ID-LP format (the separation of constructions and the principles that order their daughters) and ‘Linearization Theory’, the augmentation of sign-based grammar to allow interleaving of daughters as an account of word order freedom. On ID-LP grammars, see Gazdar & Pullum (1981), Gazdar et al. (1985), and Pollard & Sag (1987), among others. On Linearization Theory, see Reape (1994), and Müller (1995, 1999, 2002, 2004), Donohue & Sag (1999), Katho (2000).

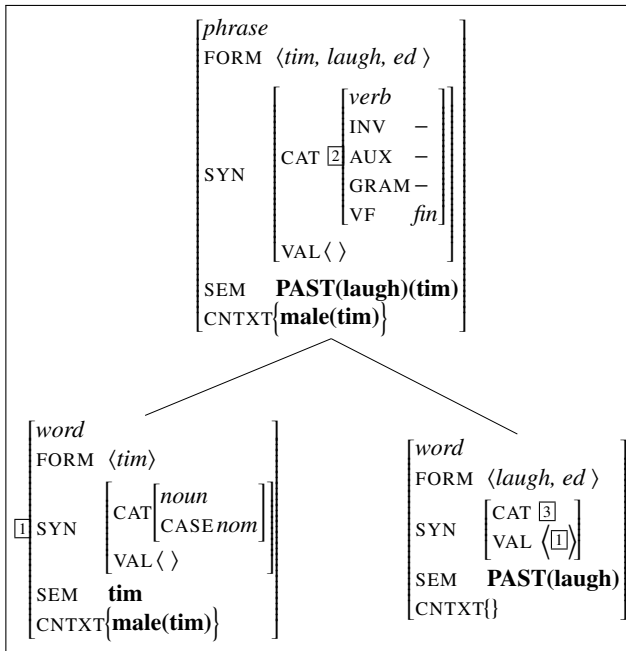

Figure 4
A Construct licensed by the Subject-Predicate Construction

like *What, me worry?* (see Akmajian (1984) and Lambrecht (1990)) and the construction responsible for absolute clauses like *My friends in jail, I'm in deep trouble* (see Stump (1985) and Culicover & Jackendoff (2005)). Each of these Subject-Head constructions is a variant of (23), and specifies idiosyncratic morpho-syntactic, pragmatic, semantic and/or phonological information.

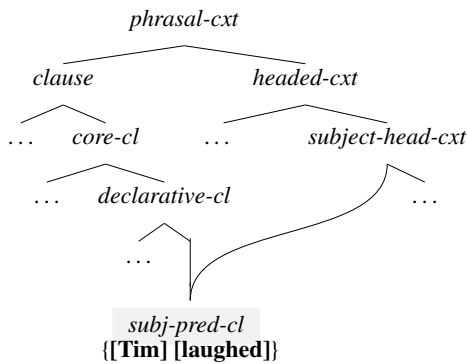

Figure 5
Types Generalizing over Subject Predicate Clauses

The type *subject-head-cxt* belongs to a complex system of constructs as in Figure 6 each of which corresponds to a class of constructions exhibiting some grammatically significant set of properties. Each such property set is specified by an implicational constraint whose antecedent is the name of that subtype.

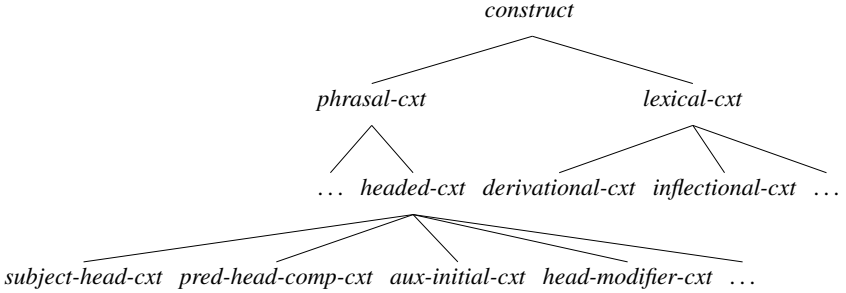

Figure 6
Construct type hierarchy

In general, the MTR value of any feature structure of type *phrasal-cxt* is required to be of type *phrase* (see Appendix). The different subtypes of *headed-cxt* provide a more or less traditional taxonomy of local dependency relations between the head-daughter and its sister(s)^[25] Thus, *subject-head-cx* licenses subject-VP phrases, *pred-head-comp-cxt* licenses head-complement phrases, *aux-initial-cxt* licenses SAI phrases, *head-modifier-cxt* licenses head-modifier phrases and so on.

Following Sag (1997) and Ginzburg & Sag (2000), phrasal constructs are in addition organized in terms of clausal types. That is, there is a subtype of *phrasal-cxt* called *clause (cl)*, which has various subtypes, including *core-cl* and *relative-cl*. The subtypes of core clause include *declarative-cl*, *interrogative-cl*, and *exclamative-cl*, as shown in Figure 7. Hence, we obtain the cross-classification shown in Figure 5. The variable grain of grammatical generalizations can be modeled precisely in such a type system, where idiosyncratic constraints can be imposed by a construction that defines the properties of a ‘maximal’ type (one that lacks subtypes), while constraints of full generality or of intermediate grain can be stated in terms of appropriate superordinate types, e.g. *construct*, or any of the subtypes of *construct* that the grammar recognizes^[26]

[25] Some abbreviations: *cl* for *clause* and *comp* for *complement*.

[26] Early work in Head-Driven Phrase Structure Grammar (HPSG) such as Flickinger et al. (1985), Flickinger (1987), and Pollard & Sag (1987) adapted multiple inheritance hierarchies, already used in computational work in knowledge representation and object-oriented programming, to express cross-classifying generalizations about words. This same general approach has subsequently been applied in various ways to the grammar of phrases by other linguists. Notable examples of such work are Hudson’s (1990, 2000a) Word Grammar, the construction-based variety of HPSG developed in Sag (1997) and Ginzburg & Sag (2000), and the variety of CxG

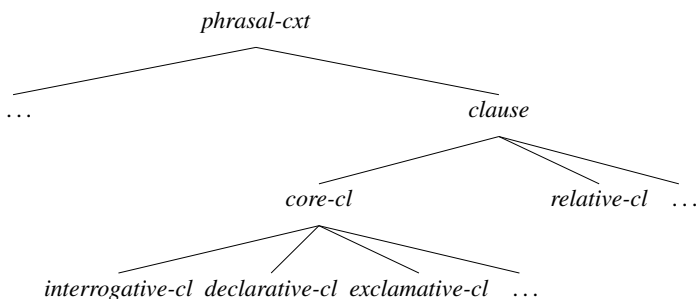

Figure 7
Clausal type hierarchy

The interplay between phrasal and clausal dimensions is of particular importance for auxiliary structures. Auxiliary verbs are distinctive in that they may introduce clausal structures of various kinds; see Culicover (1971), Fillmore (1999), Newmeyer (1998: 46–49), and Ginzburg & Sag (2000: Ch. 2.). But before moving on to SAI constructions in more detail, it is necessary to discuss the analysis of VPs. The verbal complement realization pattern typical of English VPs and predicative expressions of all categories, requires all arguments except the subject to be realized within a head-complement construct, as seen in (24). In SBCG, *L*-variables range over lists of feature structures and ‘⊕’ denotes the append relation, which concatenates two lists into one. Thus, (24) splits the valence list of the head daughter into two-sublists, one containing the subject phrase *Y*, and a list *L* containing all other subcategorized (sister) signs.

(24) **Predicational Head-Complement Construction** (\uparrow *headed-cxt*):

$$\text{pred-hd-comp-cxt} \Rightarrow \left[\begin{array}{l} \text{MTR} \left[\begin{array}{l} \text{SYN } X \uparrow [\text{VAL } \langle Y \rangle] \\ \text{SEM } \mathbf{F}(\mathbf{X}_1, \dots, \mathbf{X}_n) \end{array} \right] \\ \text{DTRS} \left\langle \begin{array}{l} \text{word} \\ \text{SYN } X: \left[\begin{array}{l} \text{CAT} \left[\begin{array}{l} \text{AUX-} \\ \text{INV-} \end{array} \right] \\ \text{VAL } \langle Y \rangle \oplus L: \langle [\text{SEM } \mathbf{X}_1], \dots, [\text{SEM } \mathbf{X}_n] \rangle \end{array} \right] \\ \text{SEM } \mathbf{F} \end{array} \right\rangle \oplus L \end{array} \right]$$

More informally, (24) requires (a) the mother’s SYN value to be identical to that of the head daughter, except for the value of VAL; (b) The mother’s VAL list to be singleton, containing just the first member (*Y*) of the head daughter’s VAL list; and

emanating from Berkeley, beginning in the mid 1980s (see Fillmore et al. (1988), Fillmore (1999), Kay & Fillmore (1999), and Goldberg (1995)); see also Zwicky (1994), Kathol’s (1995, 2000) analysis of German clause types, as well as the proposals made in Culicover & Jackendoff (2005). In all of these traditions, generalizations about constructions are expressed through the interaction of a hierarchy of types and the type-based inheritance of grammatical constraints.

(c) the mother's semantics to be arrived at by applying the head daughter's SEM value to the SEM value of its first valent, applying the resulting function to the SEM value of the next valent, and so on, until all valents (the construct daughters) have contributed. An example of the application of (24) is in Figure 8^[27]

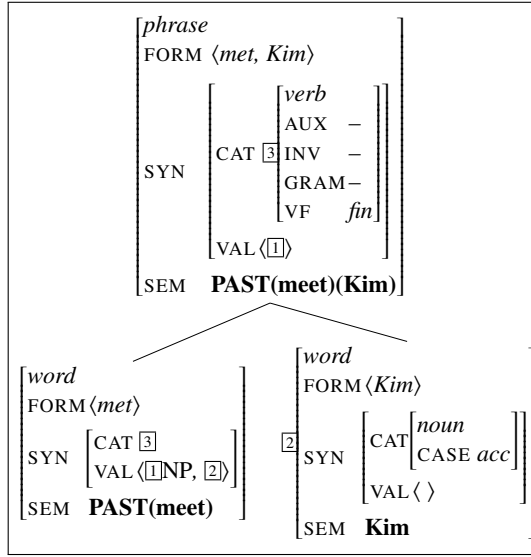

Figure 8
A Predicational Head-Complement Construct

We can now illustrate the analysis of a simple subject-predicate clause. As already discussed, all non-auxiliary verbs are subtypes of *lexical-v-lxm* and required to be AUX- and INV- by the constraint in (17b). In contrast, auxiliary verb lexemes are raising verbs and subtypes of either *aux1-v-lxm* or *aux2-v-lxm*, as shown in Figure 4. Thus, auxiliaries are exempt from (17b) as (25) illustrates^[28]. Consequently, the AUX and INV values of auxiliary verb lexemes are not fixed.

[27] An analogous rule handles head-complement constructions in which there is no subject, such as non-predicative prepositions, nouns, and adjectives and their complements. Following Bender & Flickinger (1999) and Sag (2012), one can distinguish which valent if any is the subject via the feature XARG. We have omitted this feature from this work for ease of exposition.

[28] The modal *can* is an auxiliary verb of type *aux1-v-lxm*, which as we shall see, will cause the modal to have narrow scope when negated. Other auxiliaries, such as epistemic *may*, are of type *aux2-v-lxm*, which forces the modal to have wide scope when negated.

(25)

aux1-v-lxm	
FORM	<i><can></i>
SYN	CAT $\left[\begin{array}{l} \text{VF} \quad \textit{fin} \\ \text{GRAM} \quad - \end{array} \right]$
	VAL $\langle X, [\text{VF } \textit{base}] \rangle$
	SEM can

Unlike other verbs, modals are in general finite – they appear where finite nonauxiliary verbs do, assign nominative case to their subjects, and cannot appear as complements of other verbs. All of this is straightforwardly accounted for by assuming listemes like (25), which state that the verb form is finite. Moreover, because inflectional constructions such as the preterite require the lexeme daughter to be specified as [VF *base*], it follows that modals cannot be inflected by such constructions. The way lexemes which do not inflect become words is via the general construction in (26).²⁹

(26) **Zero Inflection Construction** ($\uparrow \textit{infl-cxt}$):

$$\textit{zero-infl-cxt} \Rightarrow \left[\begin{array}{l} \text{MTR} \quad X! \textit{word} \\ \text{DTRS} \quad X: \textit{lexeme} \end{array} \right]$$

Hence, base form verbal lexemes like *be* are ‘promoted’ to words – and as a consequence, allowed to appear in the DTRS list of phrasal constructions – as are finite modals like *can* in (27), and more generally adverbs, proper names, prepositions, etc.

(27)

word	
FORM	<i><can></i>
SYN	CAT $\left[\begin{array}{l} \textit{verb} \\ \text{AUX} \quad - \\ \text{INV} \quad - \\ \text{GRAM} \quad - \\ \text{VF} \quad \textit{fin} \end{array} \right]$
	VAL $\left\langle \left[\begin{array}{l} \text{VP} \\ \left[\begin{array}{l} \square, [\text{VF } \textit{base}] \\ \text{VAL} \quad \langle \square \rangle \end{array} \right] \end{array} \right] \right\rangle$
	SEM can

This analysis thus allows *can* to be a verb with the specifications [AUX –] and [INV –] as seen below, in which case it is compatible with both the Predicational Head-Complement Construction in (24) and the Subject-Predicate Construction in (23). Consequently, sentences like the one in Figure 9 are licensed.

[29] Auxiliary verb forms of standard American English are few in number, and are all finite verbal forms, except for (base form) *be*, *being*, *been*, (base form) *have*, *having*, and infinitival *to*.

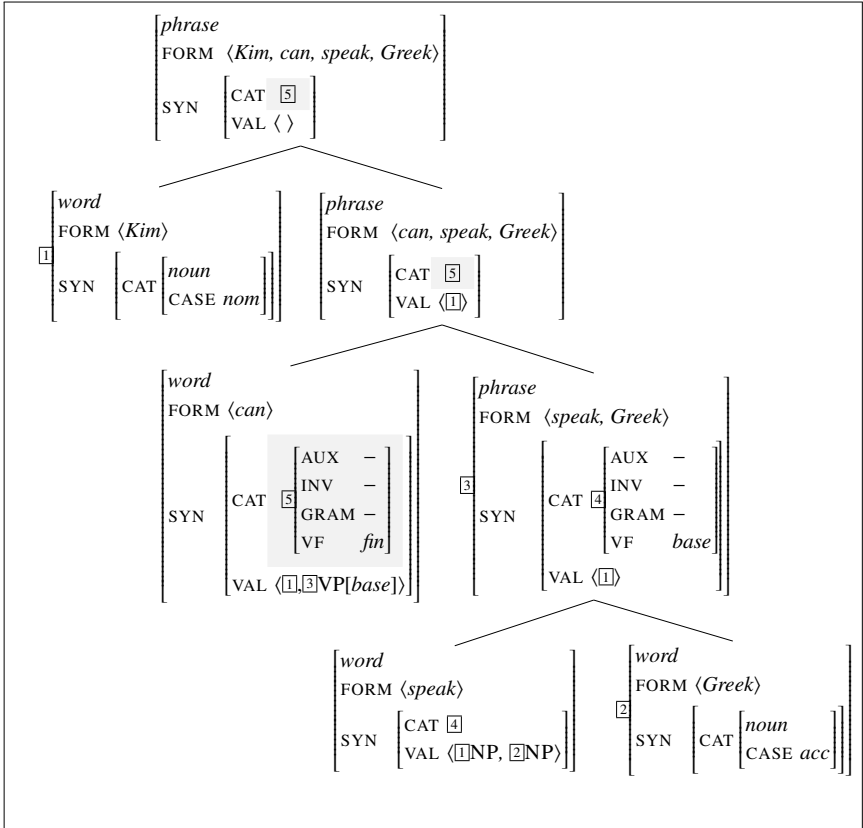

Figure 9
A Subject-Predicate Clause

So, as in previous analyses using the feature AUX (e.g. that of Ross (1969)), auxiliaries are treated uniformly as verbs. But in the present context, the feature AUX has a new and quite different interpretation. In previous analyses, [AUX +] elements are auxiliary verbs. Here, [AUX +] elements are expressions which appear in the environments delineated in sec. 1.

As opposed to the flatter structure associated with the *Syntactic Structures* AUX analysis, the constructions discussed so far create a right-nested analysis tree for English VPs. If a finite clause includes multiple verbs, one of which is a modal, the modal must appear first because it is finite and must serve as the head of the finite VP. Moreover, the complement selected by the modal must be [VF base], as required by the modal:

- (28) a. I [could [continue to take care of them]].
- b.*I [continued [to could take care of them]].

c.*I [could [continuing to take care of them]].

d.*I [could [continued to take care of them]].

A selling point of the *Syntactic Structures* analysis of EAS appeared to be that it stipulated the order and selection properties of AUX elements in the PS rules, as in (29), an analysis that has since been abandoned:

(29) AUX → Tense (M) (have + en) (be + ing)

But the cost of this proposal is excessive – it denies syntactic category membership to both *have* and *be*^[30]. The alternate, more conservative strategy embraced here is to explain the restrictions on auxiliary order through the interaction of constraints on syntactic and semantic selection, and morphological gaps. The absence of nonfinite forms for modals accounts for (30), while the semantic restrictions on the progressive may well be sufficient to explain the deviance of (31a-b) in the same way that the deviance of examples like (32)–(33) is accounted for. For further discussion, see Binnick (1991).

(30) a.*My class should can attend. (cf. My class should be able to attend.)
b.*I will must be there. (cf. I will have to be there.)

(31) a.#My sister is having left for Europe.
b.#My sister is being leaving for Europe.

(32) a.#My sister kept having left for Europe.
b.#My sister keeps being leaving for Europe.
c.#My sister continued having left for Europe.
d.#My sister continued being leaving for Europe.

(33) a.#My sister continued to have left for Europe.
b.#My sister continued to be leaving for Europe.

The *have* lexeme under discussion here has to be distinguished from its homophonous non-auxiliary counterpart. Interestingly, in some British varieties, all forms of *have* exhibit the NICER properties, while in American varieties, nonauxiliary *have* is always a *lexical-v-lxm*, yielding the distribution in (34)^[31]

(34) a. £ Have you the time?
b. £ I haven't any scotch.
c. £ I haven't any scotch, but I know they have __ .

[30] For discussion, see Lasnik et al. (2000).

[31] We will use the symbol '£' to mark a sentence that is unacceptable in the U.S., but generally acceptable in the U.K. and the British Commonwealth.

The preceding discussion sets the stage for the analysis of auxiliary *do*, which is effected in its entirety by introducing the listeme in (35), where \mathbf{F}_{ID} is the identity function over VP meanings (i.e. this function takes VP meanings and merely outputs its input):

$$(35) \left[\begin{array}{l} \text{auxI-v-lxm} \\ \text{FORM } \langle do \rangle \\ \\ \text{SYN} \\ \\ \text{SEM } \mathbf{F}_{ID} \end{array} \left[\begin{array}{l} \text{CAT} \left[\begin{array}{l} \text{AUX } + \\ \text{VF } \textit{fin} \\ \text{GRAM } + \end{array} \right] \\ \\ \text{VAL } \left\langle X, \left[\begin{array}{l} \text{VF base} \\ \text{GRAM } - \end{array} \right] \right\rangle \end{array} \right] \right]$$

Since this listeme is specified as [VF *fin*], so are all the lexemes that it licenses. The words derived from auxiliary *do* must also be [VF *fin*], and this gives rise to signs for *does*, the finite forms of *do* and *did*, but not to any for *done*, the base form *do*, or *doing*. This is the right result for standard American varieties of English, and with a small adjustment it provides an immediate account of dialects where nonfinite auxiliary *do* is also possible^[32] Similarly, all the words derived from the lexeme in (35) are specified as [AUX +]. This has the immediate effect of making auxiliary *do* incompatible with the constructions that would require it to be [AUX –]. Recall, however, that the [AUX +] constructions are precisely the NICER constructions discussed in sec. 11. Thus, nothing prevents finite *do*, *does* or unaccented forms of *do* from projecting a VP, but no such VP can serve as the head of a subject-predicate construct, whose head daughter is required to be [AUX –]. This provides an explanation for contrasts like the following, already discussed above:

- (36) a. *Kim *díd* leave.
 b. Kim *díd* leave.

As we will see in section 8, the grammar of reaffirmation allows for sentences like (36b) by licensing [AUX +] VPs whose verb must be focused (either by accent or by the presence of a reaffirming particle). In similar fashion, the treatment of other NICER properties will provide an [AUX +] environment that will accommodate auxiliary *do* in a subject-predicate clause that also contains negation (*Chris does not object.*) or VP Ellipsis (*This one does _.*).

Finally, notice that the co-occurrence restrictions of auxiliary *do* are also accounted for in our analysis. Given the lexeme in (35), it follows that the second member of *do*'s VAL list (its VP[*base*] complement) must be [GRAM –]. This means that the VP complement of *do* cannot be headed by an auxiliary verb,

[32] For further discussion of these varieties see section 5 below.

correctly ruling out examples like those in (37), where the complement's head daughter is *be* or auxiliary *have*:

- (37) a.*My piano doesn't [be very easy to play].
 b.*My grandchildren didn't [have finished their homework on time].
 c.*Does your piano [be very easy to play]?
 d.*Did my grandchildren [have finished their homework on time]?

VPs headed by a modal or auxiliary *do* are already ruled out by the fact that these verbs have only finite forms as signs of type *word*^[33]

4. AUX-INITIAL CONSTRUCTIONS

Auxiliary verbs are distinctive *inter alia* in that they may introduce clausal structures of various kinds, as noted by Culicover (1971), Fillmore (1999), Newmeyer (1998: 46–49), and Ginzburg & Sag (2000: Ch. 2.), and as illustrated in (38). These clauses will be analyzed in terms of a family of subject-auxiliary 'inversion' phrasal constructions (each with peculiar syntactic constraints) that cross-intersect with a family of clausal constructions (some interrogative, some exclamative, some conditional, etc.). Although such structures are customarily analyzed in terms of subject-auxiliary 'inversion', here we analyze them without movement operations of any kind.

- (38) a. **Interrogatives**
 [Shall we leave]?
 Where [did they go]?
 We're late! What [does it matter if it's 2pm or 3pm]?
 How old is he [do you think]?
- b. **Exclamatives**
 (Wow/Boy,) [can she sing]!
 [Wasn't that brave of her]?!
 (Oh) [don't I know it]...
- c. **Negative Imperatives**
 [Don't you be late young man]!
- d. **Blessing/Curses**
 [May you have a fantastic birthday].
 [May all your teeth fall out].
- e. **Comparatives**
 The course was more confusing than [was the workshop].
 You're curious, and so [are we].
 I could no more get on a treadmill right now than [could I climb Mount Kilimanjaro].

[33] We assume that the construction responsible for imperative verb uses takes a base form verb and yields zero-inflected finite verbs which do not impose GRAM- on their complements, thus allowing *Don't have breakfast after 9*, *Don't be rude*, *Do have fun*, *Do be kind*, and so on.

f. **Conditionals**

[Had you warned me], we would be ready by now.

[Should there be a storm], we will stay indoors.

g. **Negative fronting**

Rarely/Never [had we seen them laugh so hard].

They didn't compare male and female circumcision, and neither [did we want to draw any distinctions between the two].

Chomsky (2010: 9) criticizes constructional analyses of SAI – such as Fillmore (1999), and Ginzburg & Sag (2000), and the present account – precisely because they distinguish several types of SAI construction, rather than resorting to a single operation (movement, i.e. External Merge). However, Chomsky's critique ignores the fact that there are syntactic, semantic and pragmatic idiosyncrasies between the various SAI constructions. For example, interrogative and exclamative SAI constructions like (38a) come in different flavors, some more idiomatic than others.³⁴ In addition, many of these SAI construction types are restricted to a small subset of auxiliary verbs. Thus, inversions like (38c) must be negative and are restricted to the auxiliary *do*, (38d) are endowed with bouletic modality and restricted to the auxiliary *may*, (38f) have conditional meaning that is otherwise missing from all other SAI constructions and are restricted to a couple of auxiliary verbs, and (38g) require a clause-initial adverb. Every theory must be able to account for these idiosyncratic facts, and constructional frameworks can capture them directly, in terms of the specific syntactic, semantic and pragmatic constraints introduced by each kind of SAI construction. Finally, Chomsky's objection also ignores the fact that treating the various SAI constructions as subtypes of a single type means that no generalizations are missed.

As already discussed above, SAI constructions clearly instantiate distinct sub-constructions, each involving a language-particular correlation of aux-initial form with a particular meaning, as well as other kinds of idiosyncrasy. On the other hand, they also exhibit a 'family resemblance' which we capture via (39).³⁵

[34] In fact, even simple interrogatives like *What was her name?* can instantiate various kinds of interrogative inquiry, including rhetoricals (in which case the Question Under Discussion is whether the hearer knows the answer or not), self-addressed questions (which have a peculiar intonation and discourse requirements), and standard interrogatives (information requests). Hence, three different clause types that share the same construction form.

[35] Note that we are here following Fillmore (1999), who argues that there is no general semantics shared by all aux-initial constructions. This is a controversial point; see Goldberg (2006, 2009), Borsley & Newmeyer (2009), and the references cited there. We also follow Ross (1967) in assuming that there is no grammatical ban on clausal subjects in SAI, and that such examples are sometimes low in acceptability for performance reasons. At stake are examples like (i) and (ii) which at least some speakers deem acceptable, especially if the subject phrase is separated from the rest of the utterance by prosodic breaks.

- i. Would [whether or not we arrive on time] really make a difference?
- ii. Was [that he lied to you] really disappointing?

(39) **Aux-Initial Construction** (\uparrow *headed-cxt*):

$$\text{aux-initial-cxt} \Rightarrow \left[\begin{array}{l} \text{MTR} \quad [\text{SYN } X ! [\text{VAL } \langle \rangle]] \\ \text{DTRS} \quad \left\langle \left[\begin{array}{l} \text{word} \\ \text{SYN } X : \left[\begin{array}{l} \text{CAT} \quad [\text{INV } +] \\ \text{VAL} \quad L : \text{nelist} \end{array} \right] \end{array} \right] \right\rangle \oplus L \end{array} \right]$$

This construction requires that in *aux-initial* clauses, the head daughter (the first daughter, as indicated in the DTRS list) must be a [INV +] word, which guarantees that all such constructs are headed by an ‘invertible’ finite auxiliary verb. The sisters of the head daughter are identified with the elements of its VAL list and hence correspond to its subject and any other valents that it selects. Since the mother’s VAL list is empty, the constructed clause cannot combine with further valents (i.e. it is ‘valence-saturated’). In this view, learning to produce SAI constructions amounts to learning that such constructions begin with a [INV +] word that selects the subsequent expressions, and there is no reason at all to think this is mysterious, as proposed, for example, in Estigarribia (2007, 2010). This simply requires that (i) the child correctly classifies [INV +] words (which can be done on the basis of positive evidence) and (ii) that the child can produce/recognize valents that are independently syntactically licit. Importantly, this view predicts certain errors if the child miscategorizes a word as [INV +] that isn’t, or if the child builds an incorrect valent (for example, because the child doesn’t know how to form relative clauses). But there are other errors that the child can make. For example, before the (39) construction is learned, the child may use a strategy to add a [INV +] word at the beginning of a regular sentence (Estigarribia 2010), yielding auxiliary doubling, which is attested in on average 14% of child attempts in Ambridge et al. (2008). These may be either competence or performance-related errors, but whichever the case may be, the evidence is not only consistent with a constructional account of SAI, but receives a plausible explanation within the present framework, in terms of interference of a regular Subject-Predicate construction with a finite head.

The constraint in (39) describes the common properties of *aux-initial* clauses. At a finer grain, we find particular varieties of *aux-initial* clause, each with its own distinctive meaning, as illustrated in Figure 10 for two kinds of *aux-initial* construct: *polar-interrogative-clause* (*polar-int-cl*) and *aux-initial-exclamative-clause* (*aux-initial-excl-cl*). The former must simultaneously obey (39) and the constraints that define *interrogative-clause*; the latter must simultaneously obey (39) and the constraints that define *exclamative-clause*. A construct of the former type is in Figure 11, licensed by the *polar-interrogative-cl* construction in (40).

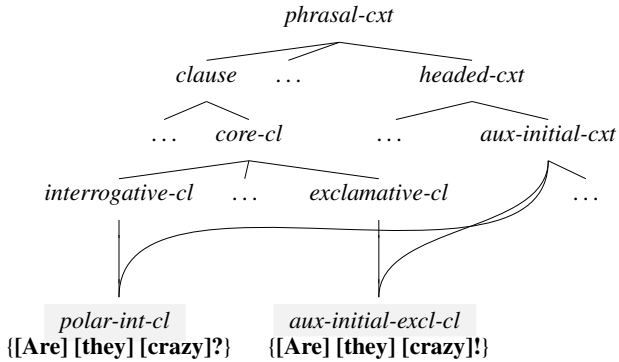

Figure 10
Two Types of Aux-Initial Clause

(40) **Polar Interrogative Construction** (\uparrow *aux-initial-cxt* & \uparrow *interrogative-cl*):

$$polar-int-cl \Rightarrow \begin{array}{l} \left[\begin{array}{l} \text{MTR} \quad \left[\begin{array}{l} \text{SYN} \quad [\text{CAT} \quad [\text{IC} \quad +]] \\ \text{SEM} \quad \lambda\{ \} [\text{FR}(\mathbf{V}_1, \dots, \mathbf{V}_n)] \end{array} \right] \\ \text{DTRS} \quad \left\langle [\text{SEM} \quad \mathbf{V}_1] \dots [\text{SEM} \quad \mathbf{V}_n] \right\rangle \end{array} \right] \end{array}$$

If grammars involve direct construction of signs, rather than movement, then the interrogative is not derived from an uninverted structure, as noted by Marcus et al. (2003). Chomsky’s famous auxiliary puzzle in (41) thus presents no particular challenge, as there is no way for (40) to derive (41b). The puzzle of the deviance of (41c) is an artifact of a transformational approach to aux-initial word order.

- (41) a. [The man [who **was** running]] **is** bald
- b. **Is** [the man [who **was** running]] bald?
- c. ***Was** [the man [who running]] **is** bald?

An analogous treatment provides each other kind of aux-initial clause with its own semantics and grammatical restrictions, thus enabling the analysis sketched here to ‘scale up’ to account for the complete set of English aux-initial constructs.³⁶ The non-*wh*-question meaning $\lambda\{ \} [\text{PAST}(\text{get}(\text{the-job}))(\text{Kim})]$ is formed by λ -abstracting over the empty set to produce a function that maps the empty set (as opposed to a nonempty set of *wh*-parameters) onto the same proposition that *Kim got the job* denotes. See Ginzburg & Sag (2000) for details.

Head movement analyses of inversion have accounted for the basic pattern of alternation: tensed auxiliary verbs appear in situ and, when other factors

[36] The positive specification for the feature INDEPENDENT-CLAUSE (IC) in Figure 11 ensures that the phrase licensed by this construct cannot function as a subordinate clause, except in those environments where ‘main clause phenomena’ are permitted. See section 8 below.

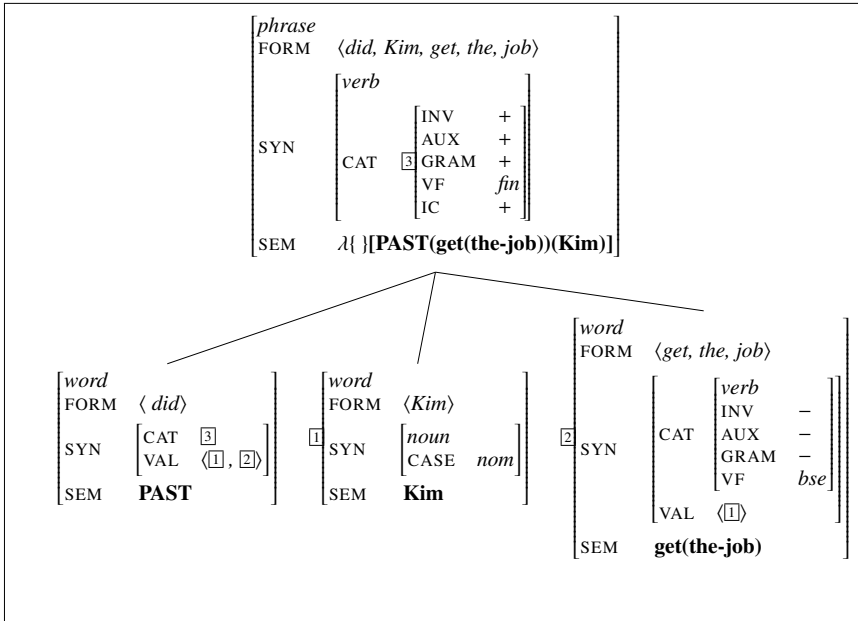

Figure 11
Analysis of *Did Kim get the job?*

permit, they appear in inverted position. In nontransformational accounts like Gazdar et al. (1982) there are two possible positions where finite auxiliaries can be directly realized. Interacting factors constrain the choice. Yet in inversion too, there is a certain degree of lexical idiosyncrasy that stands as a challenge for any analysis of EAS. First, there is the well-known contrast in (42).

- (42) a. I shall go downtown.
- b. Shall I go downtown?
 (Chomsky 1981: 209)

Whereas the auxiliary verb *shall* in (42a) conveys simple futurity, the one in (42b) has a deontic sense. One might think this difference in interpretation has something to do with interrogativity, rather than inversion. However, there is a further fact about such contrasts not noticed by Emonds, Chomsky, or Gazdar et al. The simple futurate reading is possible in an uninverted embedded interrogative like (43):

- (43) a. [To a fortune teller:] Tell me whether I shall go downtown.
- b. [To a fortune teller:] I am asking you whether I shall go downtown.

Moreover, it seems too strong to rule out all inverted instances of futurate *shall*, given the possibility of a futurate interpretation of (44):

(44) Shall we be home in time for tea, do you think?

It seems that the ‘unexpected’ fact here is the unavailability of the deontic reading in (42a). This is accomplished by positing two distinct listemes, like those in (45). By leaving futurate *shall* unspecified for INV, we allow inverted ‘shall’ to receive either a futurate or a deontic interpretation.

- (45) a.
$$\left[\begin{array}{l} \text{aux1-v-lxm} \\ \text{FORM } \langle \textit{shall} \rangle \\ \\ \text{SYN } \left[\begin{array}{l} \text{CAT } \left[\begin{array}{l} \text{INV } + \\ \text{GRAM } - \\ \text{VF } \textit{fin} \end{array} \right] \\ \text{VAL } \langle X, [\text{VF base}] \rangle \end{array} \right] \\ \text{SEM } \mathbf{SHALL}_{\text{deon}} \end{array} \right]$$
- b.
$$\left[\begin{array}{l} \text{aux1-v-lxm} \\ \text{FORM } \langle \textit{shall} \rangle \\ \\ \text{SYN } \left[\begin{array}{l} \text{CAT } \left[\begin{array}{l} \text{GRAM } - \\ \text{VF } \textit{fin} \end{array} \right] \\ \text{VAL } \langle X, [\text{VF base}] \rangle \end{array} \right] \\ \text{SEM } \mathbf{SHALL}_{\text{fut}} \end{array} \right]$$

Similarly, the following pair exhibits a scope difference (examples due to John Payne, as cited by Gazdar et al. (1985: 64)):

- (46) a. Kim mightn’t go. [M ¬]
b. Mightn’t Kim go? [¬ M]

In (46a), the modal has scope over the negation (‘It is possible that Kim might not go.’), whereas in (46b), only the reverse scope is possible (‘Is it not the case that possibly Kim will go?’). Here, however, it seems that interrogativity, rather than inversion is determining the scope, as (46b) is paralleled by (47):

(47) We wondered if we mightn’t go with them? [¬ M]

We return to this matter in Section 7 below.

There are some finite auxiliary verbs that cannot appear in inverted position, as already discussed in section 2. This is the case of *better*, for example, as pointed out by Gazdar et al. (1982):

- (48) a. I better get out of here!
b. *Better I get out of here?

On distributional grounds, *better* is arguably a finite auxiliary. It projects a finite clause, for example. Though *better* cannot be inverted in questions (or other inversion constructions), it can participate in finite negation:

(49) You better not (cry).

In the present account *better* is specified as INV–, which in turn means that it cannot appear in Inversion constructions.

5. POST-AUXILIARY ELLIPSIS

The next NICER property is Post-Auxiliary Ellipsis (PAE), as in (50).^[37]

- (50) a. Kim hasn't read that, but I have __ .
 b. Are they talking to the dean? - They must be __ .
 c. Lee left before Sandy did __ .
 d. Kim would have eaten apples, and Lee would __ , too.
 e. Kim would have eaten apples, and Lee would have __ , too.

It is generally assumed, following Hankamer & Sag (1976) (HS), that PAE is distinct from Null Complement Anaphora (NCA), seen in (51).

- (51) a. They wanted me to read that, but I refused __ .
 b. Are they talking to the dean? - They must have tried __ .

PAE belongs to a class of anaphora processes HS refer to as 'Surface Anaphora', which are supposed to disallow exophoric (deictic) uses, to allow an elliptical phrase to contain the antecedent of a pronominal anaphor, and to require syntactic parallelism between the ellipsis target and the ellipsis antecedent. NCA, by contrast, belongs to HS's class of 'Deep Anaphora', and hence is supposed to allow exophora, to disallow 'missing antecedents', and to allow a looser syntactic parallelism between ellipsis target and antecedent. The data underlying this dichotomy, like so much of the critical syntactic data from the last century, seems much less clear than it once did, as has been pointed out by various scholars (Miller & Pullum 2014), sometimes on the basis of experimental evidence (Kertz 2010, Kim et al. 2011). We think the general conclusion that has been reached is that there is a difference in degree of difficulty between the two classes, rather than a sharp bifurcation, and that we can account for acceptability differences only by appealing to a number of interacting factors.

This could be relevant because if there is no sharp analytic distinction to be drawn between the grammar of PAE and that of NCA, for example, then there is no general ellipsis phenomenon that needs to be restricted to auxiliary verbs. However, there are important data suggesting that a distinction must be drawn. For example, only auxiliaries support pseudogapping as in (52).

- (52) a. John can eat more pizza than Mary can tacos.
 b. Mary has written more novels than John has plays.

[37] Lasnik's et al. (2000) account incorrectly rules out non-base form VP ellipsis like (50d,e).

c.*Ann seems to buy more bagels than Sue seems cupcakes.

Second, Arnold & Borsley (2010) note that whereas auxiliaries can be stranded in certain non-restrictive relative clauses such as (53), no such possibility is afforded to non-auxiliary verbs as (54) illustrates.

- (53) a. Kim will sing, which Lee won't.
 b. Kim has sung, which Lee hasn't.
 c. Kim is singing, which Lee isn't.

- (54) a.*Kim tried to impress Lee, which Sandy didn't try.
 b.*Kim persuaded Lee to go, which he didn't persuade Sandy.

It is possible that these and other ellipsis contrasts are due to factors that are independent of the auxiliary verb class, but we believe that an AUX-sensitive ellipsis process remains, as otherwise it is unclear how to account for (55).

- (55) a.*Kím díd leave.
 b. Kím díd _ .

For this reason, we continue to treat PAE as an AUX-related matter, although we are aware of the problems involved with the criteria proposed in the literature to motivate the deep/surface distinction. The analysis of PAE involves a single derivational (i.e. lexeme-to-lexeme) construction which removes the complement from the VAL list of the auxiliary verb as seen in (56).

(56) **Post-Auxiliary Ellipsis:** (\uparrow *der-cxt*)

$$\begin{array}{l}
 \text{pae-cxt} \Rightarrow \\
 \left[\begin{array}{l}
 \text{MTR} \left[\begin{array}{l}
 \text{FORM } Y \\
 \text{SYN} \left[\begin{array}{l}
 \text{CAT } U ! [\text{AUX } \textit{bool}] \\
 \text{VAL } L_{\textit{ne-list}}
 \end{array} \right] \\
 \text{SEM } Z(\mathbf{V}') \\
 \text{CNTXT } [\text{SAL-UTT } \{\{\text{SEM } \mathbf{V}'\}, \dots\}]
 \end{array} \right] \\
 \text{DTRS} \left\langle \left[\begin{array}{l}
 \text{FORM } Y \\
 \text{SYN} \left[\begin{array}{l}
 \text{CAT } U : [\text{AUX } +] \\
 \text{VAL } L \oplus (X)
 \end{array} \right] \\
 \text{SEM } Z
 \end{array} \right] \right\rangle
 \end{array} \right]
 \end{array}$$

The daughter lexeme in (56) is required to have (at least) two elements in its VAL list, the last of which, *X*, is not present in the mother's non-empty VAL list. The mother's semantics is the result of applying the daughter's SEM (*Z*) to the variable *V'*. The value of the latter variable is assigned a value in context, on the basis of

the meaning of a salient utterance (SAL-UTT) in the context of utterance, subject to general principles of the theory of ellipsis, worked out in Ginzburg & Sag (2000), Culicover & Jackendoff (2005), Sag & Nykiel (2011), Jacobson (2008) and Miller & Pullum (2014). So on the basis of the PAE Construction in (56) and the existence of a lexeme like (57), the grammar licenses both AUX+ and AUX- lexemes, since AUX is underspecified in the mother node. This derivation is illustrated in Figure 12.

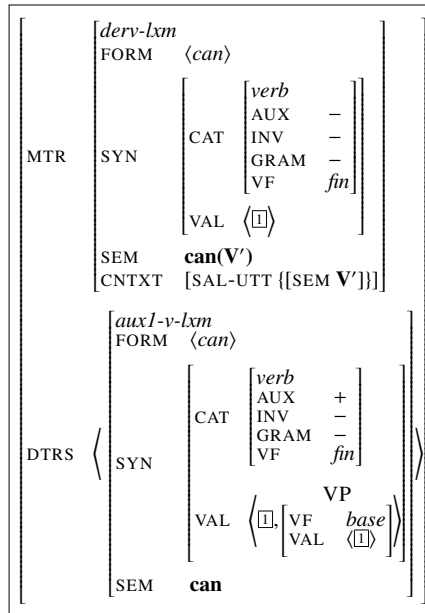
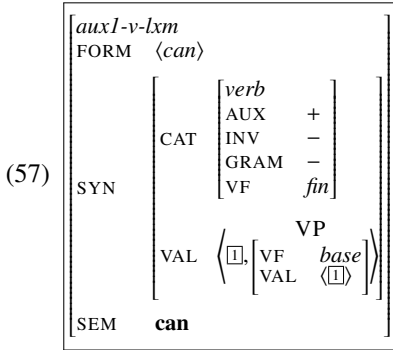

Figure 12
Derivation of the PAE use of *can*

The lexeme-to-word Zero Inflection construction discussed above in (26) can then apply to the lexeme in the mother node of Figure 12 and give rise to the

word at the bottom of the tree in Figure 13, a phrasal construction licensed by the Predicational Head Complement Construction in (24).

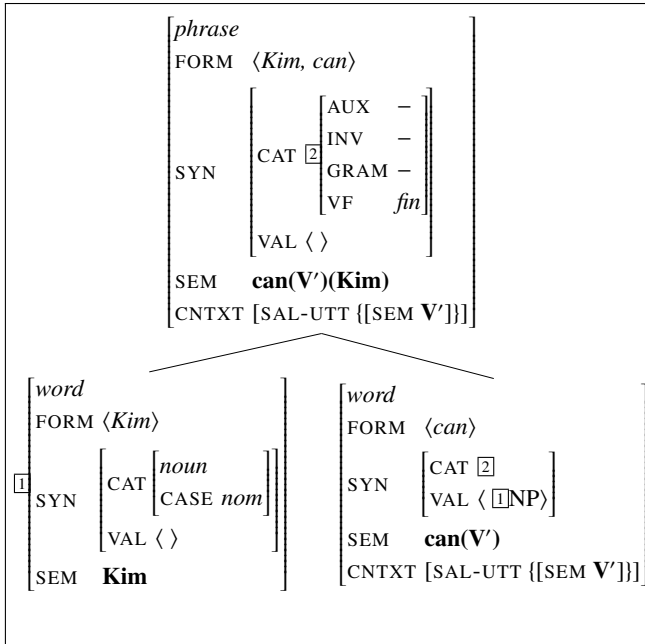

Figure 13
Analysis of *Kim can*.

Given that the PAE Construction allows *can* to be AUX+, it also follows that the verb *can* appear in Aux-Initial Constructions instead, as licensed by the phrasal construction in (39) and illustrated in Figure 14.

Transformational approaches developed in a rich tradition originating with Chomsky (1955), have assumed that the auxiliary *do* is transformationally inserted when a tense element – pressed into service as an independent syntactic atom – is ‘stranded’ by the application of transformational rules. Such rule applications are involved in the analysis of all the NICER properties, and hence *do* appears in precisely those environments³⁸ It is interesting, therefore, to consider the distribution of *do* in British English and related varieties. The following examples are discussed by Miller (2013) and references cited.

- (58) A: Does Mr Charley Newton live here?
B: He might **do**.
(BBC, *Westway*, 23 nov 2001)

[38] For a survey of the issues surrounding this tradition of analysis, consult Lasnik et al. (2000).

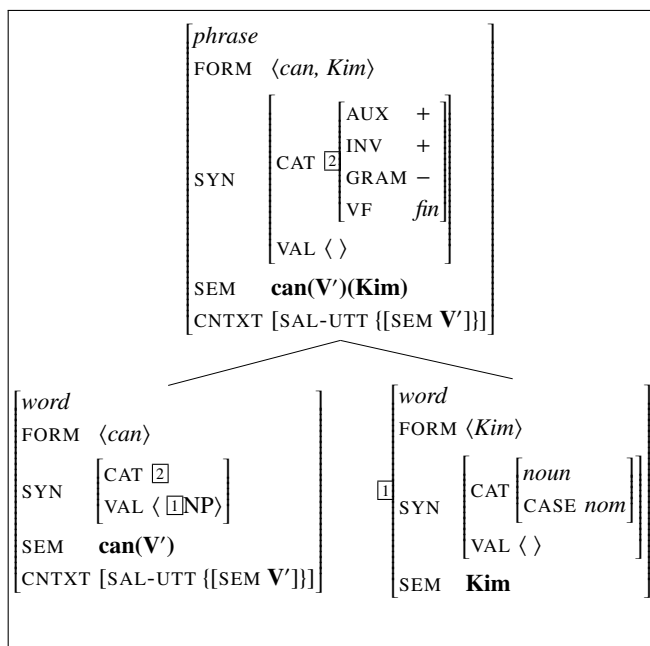

Figure 14
Analysis of *Can Kim?*

- (59) For one thing, a postponement will be seen worldwide as a declaration that Britain is in crisis; tourism would suffer even more than it is **doing** already. (*The Guardian*, 24/03/2001)
- (60) So far, everything that could go wrong has **done**. (*The Guardian*, 26/05/2001)
- (61) PM: This wouldn't appeal to you?
It might have **done**. (British speaker)
- (62) Miss Chadwick indeed looked ten years older than she had **done** on the day of the opening of term. (Agatha Christie. *Cat Among the Pigeons*. Fontana, 1962, Harper Collins, 1959, p. 190)

These forms of *do* appear only in the context of PAE, as the ungrammatical examples in (63) demonstrate:

- (63) a. *She might do read detective novels.
b. *He might have done broke(n) it.
c. *It was doing raining.

The transformational analysis provides no obvious way of generalizing to these examples of 'unAmerican nonfinite *do*': Under reasonable assumptions

about the grammar of *do* and tense, they simply have no interaction here. Hence *do*-support will have nothing to do with the analysis of (58)–(62). But these examples, as Miller argues, involve nonfinite forms of the same auxiliary *do* that in other varieties exhibits only finite forms. A lexical analysis of *do* (e.g. where the nonfinite form is listed in the lexicon already in PAE form) is preferable because it provides the basis for a natural account in terms of variations in lexical form, an independently well-established kind of dialectal variation. The nonfinite forms of auxiliary *do* also show that there are lexical forms in certain varieties of English which require PAE. Other forms, e.g. *being* (in all varieties, as far as we are aware) are systematic exceptions to PAE:³⁹

- (64) a. *Kim wasn't being careful, but Pat was being.
 b. Kim wasn't being careful, but Pat was.

6. NEGATION

Ever since Klima (1964), it has been known that there is a distinction to be drawn between constituent negation and what Klima refers to as 'sentential' negation. It is important to understand that this is fundamentally a syntactic distinction. Sentential negation, for example, cannot be equated with 'denial', 'discourse negation', and the like, as it sometimes is:⁴⁰

6.1. Constituency

Constituent negation involves structures like those in (65a), while sentential negation leads us, we argue, to structures like (65b):

- (65) a. Constituent Negation: b. Sentential Negation:
- VP_{nonfin}

$\left[\begin{array}{l} \text{FORM} \\ \text{SYN} \end{array} \right] \begin{array}{l} \langle \text{not} \rangle \\ \text{ADV} \end{array} \text{VP}_{\text{nonfin}}$

VP_{fin}

$V_{\text{fin}} \left[\begin{array}{l} \text{FORM} \\ \text{SYN} \end{array} \right] \begin{array}{l} \langle \text{not} \rangle \\ \text{ADV} \end{array} \text{Complements}$

The assumption that both types of negation exist leads us to the conclusion that a sentence like (66) is ambiguous (indicated by '&').

- (66) & Kim can not do that.

[39] We follow Warner (2000). These contrasts were first noted by Akmajian & Wasow (1975).

[40] The precise definition of the various subcategories relevant to the analysis of negation is a subtle matter that has been the subject of considerable debate. I follow Kim & Sag (2002)'s analysis in the main, though we incorporate and adapt further insights from Warner (2000). For a useful discussion of related issues in both analytic and historical terms, see Horn (1989: Ch. 3).

In addition, it's predicted that the two types may cooccur within a single sentence, as illustrated in (67):

(67) Kim cannot [not take advantage of that offer].

Thus for any given example involving post-auxiliary *not*, it is not clear in advance whether *not* is instantiating constituent or sentential negation.

6.2. VP Constituent Negation

When *not* negates an embedded constituent, it behaves much like the negative adverb *never* (see Baker (1989)):

- (68) a. Kim regrets [never/not [having read the book]].
 b. We asked him [never/not [to try to read the book]].
 c. Duty made them [never/not [miss the weekly meeting]].

Kim & Sag (2002) account for these and other properties of constituent negation by regarding *not* as an adverb that modifies nonfinite VPs, rather than as a head of its own functional projection, as is often assumed in Movement-based discussions. On their analysis, modifiers of this kind precede the elements they modify, thus accounting for the contrasts between (69a,b) and (70a,b)^[41]

- (69) a. [Not [_{VP} speaking English]] is a disadvantage.
 b.*[_{VP} Speaking not English] is a disadvantage.
- (70) a. Lee is believed [not [_{VP} to like Chris]].
 b.*Lee is believed to [_{VP} like not Chris].

And *not*'s lexical entry includes a constraint ensuring that the VP it modifies is nonfinite:

- (71) a.*Pat [not [_{VP} left]].
 b.*Pat certainly [not [_{VP} talked to me]]
 c.*Pat [not [_{VP} always agreed with me]].
- (72) a. I saw Pat acting rude and [not [_{VP} saying hello]].
 b. I asked him to [not [_{VP} leave the bar]].
 c. Their having [not [_{VP} told the truth]] was upsetting.

[41] Related kinds of negation are those that modify other kinds of phrases, such as 'not many people', 'a not very difficult problem', etc.

Syntactic evidence exists to confirm the indicated constituency in most cases, e.g. the possibility of *it*-clefts and *wh*-clefts with the negated VPs as focus:⁴²

- (73) a. It's [not being invited to the party] that they resent.
 b. It's [not to be invited to the party] that they prefer.
- (74) a. What they resented was [not being invited to the party].
 b. What they preferred was [not to be invited to the party].

It is an important semantic fact that the scope of a modifier adjoined to a VP always includes that VP, as illustrated in (75):

- (75) a. Kim [never [said you were invited]].
 (**never(said(invited...))**; ***said(never(invited...))**)
- b. Kim [carelessly [never [finished the assignment]]].
 (**carelessly(never(finish...))**; ***never(carelessly(finish...))**)

Moreover, VP-adjoined modifiers can never outscope a higher verb. This entails that in examples like (76a–d), the finite verb always outscopes the adverb:

- (76) a. Kim seems [never [to be alone]].
 b. Kim seems [not [to like anchovies]].
 c. Pat considered [always [doing the homework assignments]].
 d. Pat considered [not [doing the homework assignments]].

The lexical entry for *not* (like that of any scopal modifier) thus includes the information that the VP it modifies is its semantic argument.

Finally, note that the constituent modifier analysis of *not*, forced by the presence of *And so can we* (Klima (1964); Horn (1989)), predicts the existence of ambiguities like (77a,b):

- (77) a. Dana can not register and attend. And so can we.
 b. Dana can [[not [register]] and [attend]].
 c. Dana can [not [[register] and [attend]]].

It also correctly predicts the lack of ambiguity in examples like (78):

- (78) Dana could [[register] and [not attend]] (, couldn't she?)

[42] Notice, however, that the VP complements of auxiliary verbs do not allow clefting and hence cannot provide further support for the relevant VP structures:

- (i) *It's [(not) go to the party] that they should.
 (ii) *What they should is [(not) go to the party].

In non-‘challenge’ uses, the polarity of the tag must be opposite to that of the sentence to which it is adjoined. The auxiliary in the tag here is negative, indicating that the sentence it is adjoined to is positive, even though it contains *not*. This is the general pattern predicted by the constituent negation analysis, again following Klima (1964) and Horn (1989).

6.3. Sentential Negation

Sentential negation involves an auxiliary verb and the adverb *not*:

(79) Dominique could not open the door.

Di Sciullo & Williams (1987) have suggested that sentential negation should be analyzed (as the exceptional orthography for *cannot* suggests) in terms of a morphological combination of a finite verb with *not*. Bresnan (2000) proposes that *not* is a modifier adjoined to the finite verb, as in (80):

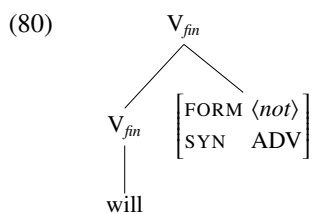

But both these analyses seem inconsistent with examples like the following:

- (81) a. They will obviously not have time to change.
 b. You are usually not thinking about the right problem.
 c. They are obviously not good citizens.
 (Kim & Sag 2002)

Since the adverbs in these examples can outscope the preceding auxiliary (e.g. *obviously* and *not* can outscope *will* in (81a)), they are unlike the VP-modifiers discussed above. Moreover, the fact that (non-challenge) tag questions like the one below are formed with a positive auxiliary further suggest that this use of *not* must have wide scope:

(82) They will obviously not have time to change, will they?/*won't they?

We regard the occurrences of *not* in (81a-c) as instances of sentential negation. The evidence speaks strongly against the morphological incorporation analysis, as it would require, for example, that sequences like *will-obviously-not* be treated as a single word, an unintuitive consequence lacking independent motivation. Moreover, if the negation *not* were to form a morphological unit with the preceding finite auxiliary, then one would expect, contrary to fact in most

varieties, that *not* should appear in inverted structures along with the verb, as illustrated in (83):

- (83) a. He [would not] leave the city.
 b.*[Would not] he leave the city?
 c. He [need not] leave the city.
 d.*[Need not] he leave the city?

These inversions, though historically attested and still acceptable as formal variants in certain British dialects (v. Warner (2000)), are unacceptable in American varieties, where the only possible renditions of (83b,d) are (84a,b):

- (84) a. Wouldn't he leave the city?
 b. Didn't he need to leave the city?

These data present no particular descriptive challenge. In fact, since sign descriptions may include information about context (usually via the feature CNTXT), it is even possible to describe a system where examples like (83) are part of a 'formal register', assuming an appropriate theory of such has been integrated into the theory of context.

Let us return to the adverb scope dilemma raised by (81). The verb modifier analysis assigns these examples a structure like (85):

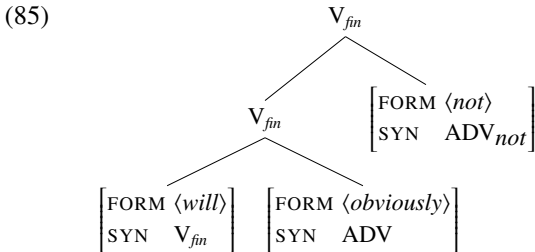

But this predicts the wrong scope, namely (86b), instead of the observed (86a):

- (86) a. **OBVIOUS (NOT (WILL (...)))**
 b.***NOT (OBVIOUS (WILL (...)))**

The syntactic verb modifier analysis thus also appears inadequate on more than one count. On the basis of diverse evidence, Kim & Sag (2002) argue that sentential negation should be distinguished from constituent VP-negation in terms of the structural contrast illustrated in (65) above. In fact, Kim and Sag argue that the negative adverb in sentential negation is selected by the verb as a complement. The argument that they make for this analysis includes: (a) evidence for a 'flat' structure where *not* is the sister of the finite verb it co-occurs with; (b) the uniform ordering of sentential negation in complement position; (c) the

impossibility of iterating the negative adverb in sentential constructions; (d) the lexically idiosyncratic nature of the scope of sentential negation; (e) the possibility of stranding *not* only in finite instances of VP ellipsis; and (f) the requirements of a systematic account of ‘polarized’ finite auxiliaries. All of these phenomena (in addition to others involving French *pas*) are naturally accounted for if finite verbs in English (and French) are allowed to select a negative adverb complement.

Let us consider some of this evidence in more detail. The interaction of sentential negation and inversion, as we have just seen, argues against a [V_{fin} *not*] structure and the adverbial interpretation facts just considered speak against a [V_{fin} [*not* VP]] structure (for sentential negation). Another argument against the latter constituency is provided by contrasts like the following, which show that in VP-fronting constructions, finite negation remains unfronted:

- (87) You said they can’t join us,...
- a. *and not join us they can __ .
 - b. and join us they cannot __ .

All of these data are consistent with a flat structure for sentential negation, i.e. the structure in (65b), which would follow straightforwardly from a verb-complement analysis, as would the position of sentential *not* (English complements uniformly appear in post-head position) and the impossibility of iterating *not* in sentential negation.

The scopal idiosyncrasies of auxiliary negation are intriguing. We have already established that constituent negation always takes narrow scope with respect to a finite auxiliary, as in (88a-c):

- (88) a. Paul could [not agree with those terms], couldn’t he?
 b. They will [not accept the offer], won’t they?
 c. Kim may [not drink the wine] if she doesn’t like it. ‘Kim is permitted not to drink...’

But the scope of sentential negation varies with the choice of auxiliary. For example, *not* outscopes *can* or *will*, but is outscoped by deontic modals like *may* or *must*:

- (89) a. My parents cannot accept that. [\neg M]
 b. Chris will not do that, will she? [\neg M]
- (90) a. Kim may not drink the wine if she doesn’t feel like it. ‘Kim possibly won’t drink the wine.’ [M \neg]
 b. Hilary must not accept the offer. [M \neg]
 c. They should not have been drinking. [M \neg]

These contrasts also show themselves in the interaction of modals with other negative adverbs, e.g. *never*, and also with positive adverbs that are permitted post-auxiliary:

- (91) a. Kim must never accept the offer. [M \neg]
 b. My parents can never accept that. [\neg M]
- (92) a. Kim must always accept the offer. [M ADV]
 b. My parents can always buy a condo. [ADV M]

Though the interaction of modals and post-modal adverbs is fixed, it seems that modals exhibit variable scope if negation is introduced nominally. The following are ambiguous.

- (93) a.& Sandy must accept nothing.
 b.& Sandy will accept nothing.
- (94) a.& Nobody must visit Pat.
 b.& Nobody in the room will visit Pat.

This last pattern is the more familiar one, as we expect in general to find scopal ambiguity. The modal-adverb interactions are only partly predictable on semantic grounds. In an important study, Warner (2000) discusses in detail the following verb classes defined in terms of their scope properties:

- (95) a. (\neg M): *can, could, may* (deontic), *need, dare, will, would*
 b. (M \neg): *may* (epistemic), *might* (epistemic), *must, shall, ought, should*

Given the partly arbitrary classification of the sort Warner observes, the motivation for a lexical analysis of the sort he proposes is clear. A modal can select for a negative adverb complement and assign it a fixed scope. By contrast, negative nominals involve no idiosyncratic selection and take scope in accordance with general interpretative principles.

In sum, there is considerable, but often subtle evidence in favor of a two-way distinction between nonfinite constituent negation and an analysis of sentential negation in terms of an adverb-selecting valence pattern for finite auxiliary verbs. We analyze sentential negation as follows. First, we group the lexemes represented in (95a) together with the various *be* and *have* lexemes into the class *aux1-v-lxm* and Warner's class in (95b) becomes the class *aux2-v-lxm*. These are referenced by the following two derivational constructions:⁴³

- (96) **Wide Negation Construction** (\uparrow *der-cxt*)

[43] For ease of presentation, we leave certain information redundantly expressed in both negation constructions. In fact, these can be viewed as two constructions with a common superordinate. See the Appendix for details.

$$\text{wide-neg-cxt} \Rightarrow \left[\begin{array}{l} \text{MTR} \left[\begin{array}{l} \text{FORM } Z \\ \text{SYN} \left[\begin{array}{l} \text{CAT } [\text{VF } \textit{fin}] \\ \text{VAL } \langle X, \text{ADV}_{\textit{not}} \rangle \oplus L \end{array} \right] \\ \text{SEM } \mathbf{C}_{\textit{wide-not}}(\mathbf{V}) \end{array} \right] \\ \text{DTRS} \left\langle \left[\begin{array}{l} \textit{aux1-v-lxm} \\ \text{FORM } Z \\ \text{SYN} \left[\text{VAL } \langle X \rangle \oplus L \right] \\ \text{SEM } \mathbf{V} \end{array} \right] \right\rangle \end{array} \right]$$

(97) **Narrow Negation Construction** ($\uparrow \textit{der-cxt}$)

$$\text{narrow-neg-cxt} \Rightarrow \left[\begin{array}{l} \text{MTR} \left[\begin{array}{l} \text{FORM } Z \\ \text{SYN} \left[\begin{array}{l} \text{CAT } [\text{VF } \textit{fin}] \\ \text{VAL } \langle X, \text{ADV}_{\textit{not}} \rangle \oplus L \end{array} \right] \\ \text{SEM } \mathbf{C}_{\textit{narrow-not}}(\mathbf{V}) \end{array} \right] \\ \text{DTRS} \left\langle \left[\begin{array}{l} \textit{aux2-v-lxm} \\ \text{FORM } Z \\ \text{SYN} \left[\text{VAL } \langle X \rangle \oplus L \right] \\ \text{SEM } \mathbf{V} \end{array} \right] \right\rangle \end{array} \right]$$

Let us discuss (96) first. This derivational construction licenses a new lexeme whose VAL list extends that of any *aux1-v-lxm* listed above by adding a negative adverb (*not*). In addition, the semantics of the auxiliary is adjusted via a combinator (in a spirit similar to that of Gazdar et al. (1985); see also Klein & Sag (1985)) that will allow the semantics of the mother (an auxiliary verb) to take its arguments in multiple orders. More specifically, $\mathbf{C}_{\textit{wide-not}}$ allows an auxiliary verb (of semantic type $\langle \text{VP}, \text{VP} \rangle$) two combinatoric options: either it takes **NOT** first and then its VP argument, or in the opposite order, if SAI occurs. In either case, **NOT** scopes over the verb:

$$(98) \mathbf{C}_{\textit{wide-not}}(\mathbf{Vaux}) =_{\textit{def}} \lambda\{\mathbf{v}_1, \mathbf{v}_2\} [\mathbf{v}_1(\mathbf{Vaux}(\mathbf{v}_2))]$$

The variables \mathbf{v}_i range over argument meanings and the meanings of modifiers like **not**, that is, functions from VP meanings to VP meanings, where VPs map NP meanings to propositions (n.b. not individuals to truth values). $\lambda\{\mathbf{v}_1, \mathbf{v}_2\}$ can be instantiated either as $\lambda\mathbf{v}_1\lambda\mathbf{v}_2$ or as $\lambda\mathbf{v}_2\lambda\mathbf{v}_1$, allowing both argument orders, depending on whether SAI took place.

Now, if the lexeme licensed by (97) is fed to the lexeme-to-word Zero Inflection Construction in (26), then we obtain a sign of type *word* that produces the analysis sketched in Figure 15. Here, an ordinary predicative head-complement

construct is licensed by the construction in (24) and the auxiliary verb derived in the fashion just sketched.

Conversely, if the lexeme licensed by (97) is instead fed to the PAE construction in (56) before being fed to the Zero Inflection Construction in (26), then the VP complement is not present in VAL and we obtain VPs like *will not*. This VP is identical to the one Figure 15, except that there are only two daughters, namely *will* and *not*. Finally, if the auxiliary is used in the Aux-Initial Construction in (39) instead of the Predicational Head-Complement Construction then we obtain the inversion counterparts of the aforementioned structures.

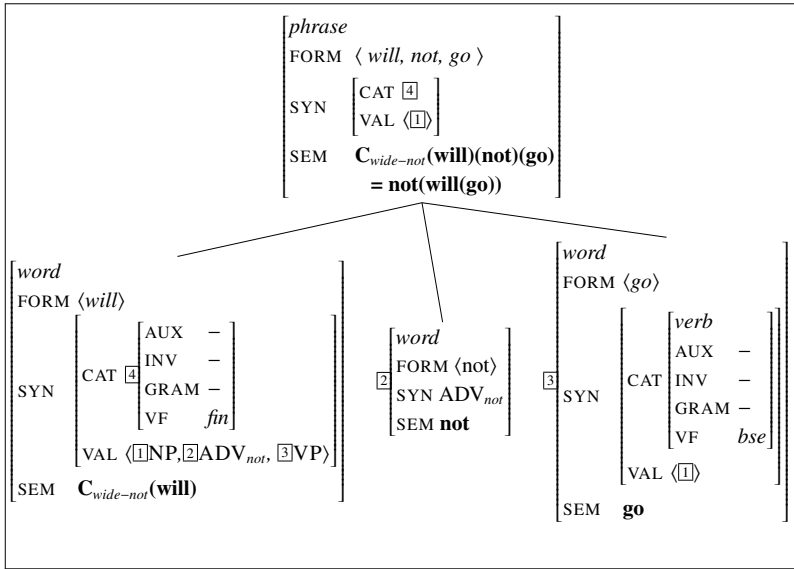

Figure 15
Analysis of *will not go*

The analysis of narrow-scope *not* is similar, given that the combinator in (97) is defined as in (99).⁴⁴ This definition ensures that the auxiliary outscopes the negation, as in Figure 16. The interaction with the lexeme-to-word Zero Inflection Construction in (26) and with the PAE and Inversion constructions is identical to that of (96).

$$(99) C_{\text{narrow-not}}(\mathbf{Vaux}) =_{\text{def}} \lambda\{v_1, v_2\} [\mathbf{Vaux}(v_1(v_2))]$$

[44] In this presentation, we have carved out a minimal set that allows 2-argument permutation and nothing more. This is misleading. There is clearly a more general theory that can be developed of combinators for natural language. The beginnings of such is sketched by Klein & Sag (1985) and Gazdar et al. (1985).

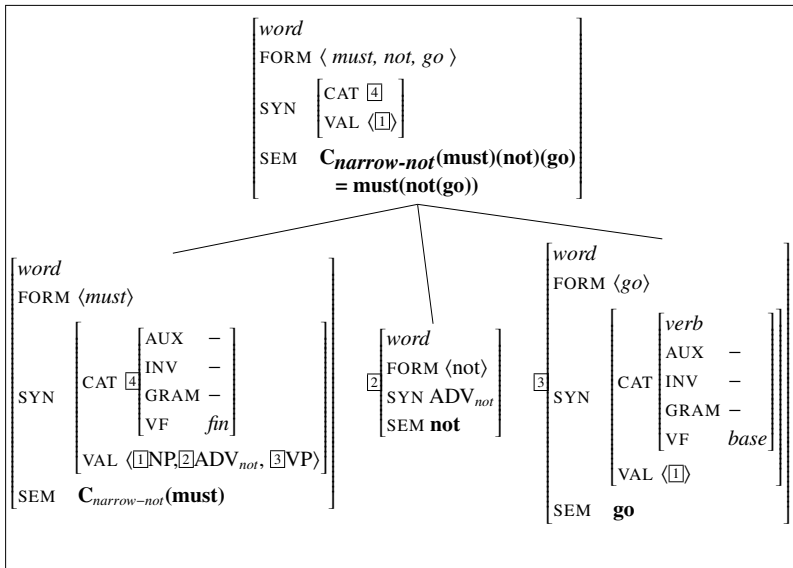

Figure 16
Analysis of *must not go*

Note that nothing in the present account prevents the iteration of sentential negation. Thus, rule (97a) can apply to its own output to yield sentences like **You need not not not exercise*, and similarly for (97b). However, the oddness of negation iteration is likely the product of two factors, namely prosodic phrasing and semantic complexity. Sentences that contain both sentential negation and VP constituent negation typically require the clausal negation to contract with the auxiliary verb, or for one of the negations be realized with stress. This is illustrated in (100), where ‘|’ indicates a prosodic break.

- (100) a. You shouldn’t not exercise.
(= ‘you should exercise’)
- b. You should NOT | not exercise.
- c. You should not | NOT exercise.
- d. ?You should not not exercise.

Following Zwicky (1986), we propose that the unstressed clausal negation must prosodically ‘lean’ (by contracting) on the its respective verbal head, analogously to unstressed pronouns. Alone, the negation cannot project its own phonological phrase. Similarly, the unstressed VP constituent negation must become part of the phonological phrase projected by the VP complement. The second factor that conspires against negation iteration is that sentences with multiple negation are not trivial to process. For example, sentences like *Didn’t Robin not stay?*, or *He would never not tell me the truth* are grammatical, but difficult to understand. It

is known that the presence of negation independently leads to higher error rates (Wason 1961), longer response times (Slobin 1966), greater cortical activation (Carpenter et al. 1999) and increased brain responses (Staab 2007) in comparison with affirmative counterpart sentences. Thus, **You need not not not exercise* is odd arguably because there is no suitable phonological phrasing and because multiple negations are excessively difficult to process.

A second instance where negation interacts with prosody has to do with inversion. Whereas examples like (101a) are not as good as the contracted counterpart in (101b), the presence of a longer subject improves the acceptability of such constructions, as (101c,d) show. Such constructions are formal and somewhat archaic, and rather like the Heavy NP Shift construction in that the subject NP has to be fairly hefty. Again, this appears to be a matter of phonological phrasing, since the unstressed negation can either contract or prosodify with the phonological phrase projected by the non-pronominal NP.

- (101) a. ?*Will not he laugh?
 b. Won't he laugh?
 c. Will not the memories of this place be more than enough?
 d. Will not the courts be in a better position to decide this matter?

In summary, our analysis of sentential negation treats *not* as a complement of the finite auxiliary verb. Therefore, *not* is ordered after the finite verb. In sentential negation, *not* does not form a constituent with the following VP and hence never 'fronts' with the material following it. *Not* participates in lexical idiosyncrasy (scope variation) only with finite auxiliaries. Exceptional cases can be easily accommodated by the present theory. For example, negative verb forms like *need not* in (102) are not obtained via any lexical rule, given that they lack a non-negative counterpart (e.g. **You need bother with that*). These forms are simply listed as lexemes, by assuming a grammaticized form of the verb⁴⁵

- (102) You need not bother with that.

No extant movement-based account covers the range of phenomena discussed so far. As Lasnik et al. (2000: 181–190) stresses, the Minimalist analysis articulated in Chomsky (1993) fails to deal even with the ungrammaticality of even simple examples like **John left not* or **John not left*, and the account in Lasnik et al. (2000) does not analyze modal/negation scope variation or inversion idiosyncrasies.

[45] See Levine (2013) for evidence that uses of the modal *need* that take an overt complement VP are NPIs. Consequently, *I don't think you need bother with that* is licit, as a type of garden variety NPI licensing.

7. CONTRACTION

Let us now turn to the *not*-contracted forms, all of which are finite. As illustrated below, these exhibit further lexical idiosyncrasy; See Zwicky & Pullum (1983) and Quirk et al. (1985: 3.23; 3.39).

- (103) a. *won't* instead of **willn't*
 b. *don't* (/dɒnt/ instead of **/dʌnt/*)
 c. *mustn't* ([mʌsnt] instead of **/[mʌstnt]*)

Moreover, there are irregularities in the varieties that allow the forms shown in (104). We use the symbol % to indicate a form that is well-formed only in certain varieties and † to indicate an erstwhile dialectal form that now seems to be obsolescent.

- (104) a. *can't* (%/kʌnt/ instead of **/kænt/*)
 b. %*shan't*/**shalln't*

Other idiosyncratic contracted forms include the following:

- (105) †*mayn't*, %*ain't*, %*usen't*

There are also gaps in the contraction paradigm, at least in standard varieties of English (See Hudson (2000b)):

- (106) **amn't*

In addition, as first noted by Horn (1972) (see also Zwicky and Pullum 1983), contracted forms exhibit scope idiosyncrasy of the sort we have already been considering. For example, *not* must outscope the modal in the interpretation of *won't* (in either its volitional or futurate uses):

- (107) a. Pat [won't do that]. 'It's not the case that Pat will do that.'
 b. *won't*: **NOT (WILL ...)**

By contrast, the contracted forms of deontic modals like *should* exhibit the opposite scope interpretation:

- (108) a. Pat [shouldn't do that]. 'It is incumbent on Pat not to do that.'
 b. *shouldn't*: **SHOULD (NOT ...)**

In sum, the phonological and semantic idiosyncrasies documented by Horn, Zwicky, Pullum and others clearly point to a lexical analysis of *not*-contraction, i.e. one that rejects contraction as a phonological rule of the sort proffered in some generative textbooks^[46] and accepted uncritically in much of the generative literature.

[46] E.g. Haegeman (1991), Radford (2004).

Furthermore, as already noted in Section 2, there are inflected forms that only occur in inversion constructions, e.g. the first person singular negative contracted form of the copula illustrated in (109):^[47]

- (109) a. *I aren't going.
b. Aren't I going?

This is analyzed in terms of a distinct listeme that licenses the Inverted Copular Contraction Construction shown in (110):

- (110) **Inverted Copular Contraction Construction:** ($\uparrow infl\text{-}cxt$)

$$inv\text{-}cop\text{-}contr\text{-}cxt \Rightarrow \left[\begin{array}{l} \text{MTR} \left[\begin{array}{l} \text{FORM} \langle aren't \rangle \\ \text{SYN} \left[\begin{array}{l} \text{CAT} \left[\text{INV} + \right] \\ \text{VAL} \langle X_{Isg} \rangle \oplus L \end{array} \right] \\ \text{SEM} Y \end{array} \right] \\ \text{DTRS} \left\langle \left[\begin{array}{l} \text{FORM} \langle be \rangle \\ \text{CAT} \left[\text{VAL} \langle X \rangle \oplus L \right] \\ \text{SEM} Y \end{array} \right] \right\rangle \end{array} \right]$$

And this gives licenses words like (111), which can head aux-initial clauses like the ones shown in (112). The feature PRED indicates phrases that can appear in predicative position, such as certain VPs, PPs, APs, and NPs.^[48]

(111) $\left[\begin{array}{l} \text{word} \\ \text{FORM} \langle aren't \rangle \\ \text{SYN} \left[\begin{array}{l} \text{CAT} \left[\begin{array}{l} \text{INV} + \\ \text{GRAM} + \\ \text{VF} fin \end{array} \right] \\ \text{VAL} \left\langle \left[\text{NP}_{Isg}, \left[\begin{array}{l} \text{PRED} + \\ \text{VAL} \langle \text{I} \rangle \end{array} \right] \right] \right\rangle \end{array} \right] \\ \text{SEM} \mathbf{F}_{ID} \end{array} \right]$

- (112) a. Aren't I on the list?
b. Aren't I clever!

Note first person *aren't* is correctly blocked in [INV –] environments like (113).

- (113) a. *I aren't an idiot. (cf. I'm not an idiot.)
b. *There's no legislator that I aren't suspicious of. (cf. ...that I'm not suspicious of)

[47] See Palmer (1965), Hudson (1977, 2000b), Gazdar et al. (1982), and Bresnan (2000).

[48] Recall that \mathbf{F}_{ID} is the identity function over VP meanings.

c.*They wonder if I aren't a communist. (cf. ...if I'm not a communist)

Finally, Bresnan (2000) observes that in many varieties of American English, inversion and overt sentential negation are incompatible:

- (114) a. %Will Jones not stop singing?
 b. %Have your parents not been to Prague?

The only corresponding sentences in these varieties (which include most spoken American vernaculars^[49]) are those shown in (115):

- (115) a. Won't Jones stop singing?
 b. Haven't your parents been to Prague?

Since, as we have seen, finite negation is plausibly treated via complement selection, these data too are plausibly described in lexical terms. In a variety/register where examples like (114) are ill-formed, the negation constructions introduced in the preceding section could be revised to require that the mother lexeme be [INV -]. That said, there are example pairs which are more readily interpretable with sentential negation.^[50]

- (116) a. Are we not all civilized people here?
 b. Aren't we all civilized people here?
- (117) a. Why are you not getting a ride with Pat?
 b. Why aren't you getting a ride with Pat?

Leaving variational concerns aside, our analysis of contraction follows a tradition in which inversion constructions are distinguished by the feature specification [INV +]. The various quirks are then analyzed in terms of positive or negative lexical specifications for this feature, as we have seen. These exceptions work in tandem with the following postlexical (i.e. post-inflectional) construction. In short, the adverb is suppressed from VAL in the mother node, and the negation semantics is added.

[49] It may be that inversions like (114) are restricted to formal registers, even in British dialects.

[50] This leaves open the possibility that the contrasts in Bresnan (2000) may at least in part not be due to grammar proper.

(118) **Contraction Construction:** (\uparrow *post-infl-ctx*)

$$\text{contraction-ctx} \Rightarrow \left[\begin{array}{l} \text{MTR} \left[\begin{array}{l} \text{FORM} \langle F \text{Contr}(Y) \rangle \\ \text{SYN} \left[\begin{array}{l} \text{CAT} \ U \ ! \ [\text{AUX} \ \text{bool}] \\ \text{VAL} \ \langle X \rangle \oplus L \end{array} \right] \\ \text{SEM} \ Z(\mathbf{not}) \end{array} \right] \\ \text{DTRS} \left\langle \left[\begin{array}{l} \text{FORM} \ \langle Y \rangle \\ \text{SYN} \left[\begin{array}{l} \text{CAT} \ U: [\text{AUX} \ +] \\ \text{VAL} \ \langle X, \text{ADV}_{\text{not}} \rangle \oplus L \end{array} \right] \\ \text{SEM} \ Z \end{array} \right] \right\rangle \end{array} \right]$$

Postlexical constructions require both mother and daughter to be of type *word*. Note that the daughter in (118) is in addition required to be [AUX +] (ensuring that only auxiliary verbs can undergo *not*-contraction). By contrast, the mother is free to be either [AUX +] or [AUX -] (*bool(ean)* is the immediate supertype of + and -), and hence is free to appear either in the NICER environments, or else in nonauxiliary contexts like phrases licensed by the Subject Predicate Construction. In this way, the examples in both (119) and (120) are correctly licensed:

(119) a. Kim isn't arriving until tomorrow.

b. I won't grow up.

(120) a. Isn't the train arriving soon?

b. Won't he grow up?

c. He won't _ .

And a last point: the semantics of a contracted verb is just the same as the result of semantically composing the uncontracted verb with *not*. In particular, the analysis of the scope interaction of negation and modality is carried over in its entirety. The semantics of *mustn't* is the same as that of *must not*, that of *won't* mirrors that of *will not*, etc. There may be differences in the communicative potential of such pairs of course, but these are presumably more general matters of lexical variation, not part of the grammar of contraction.

PAE interacts with other aspects of our analysis so as to produce the feeding and blocking relations that are needed to generate the complex facts of EAS. First, note that the negation constructions feed PAE, by which we mean, for example, that The Wide Negation Construction licenses unary constructs whose mother is a verbal lexeme suitable to be the daughter of a construct licensed by PAE. And the mother of this last construct in turn is a verbal lexeme that can be the daughter of an inflectional construct, let's say one whose mother will be a third-singular word, as sketched in (121):

(121)

MTR	word FORM	<i><can></i>								
	SYN	CAT	<table border="1"> <tr><td>AUX</td><td>-</td></tr> <tr><td>INV</td><td>-</td></tr> <tr><td>GRAM</td><td>-</td></tr> <tr><td>VF</td><td><i>fin</i></td></tr> </table>	AUX	-	INV	-	GRAM	-	VF
AUX	-									
INV	-									
GRAM	-									
VF	<i>fin</i>									
		VAL	$\langle [1]_{3sg}, [2] \rangle$							
	SEM	$C_{wide-not}(\mathbf{can})(V')$								
	CNTXT	[SAL-UTT {{SEM V'}}]								
DTRS	word FORM	<i><can></i>								
	SYN	CAT	<table border="1"> <tr><td>AUX</td><td>-</td></tr> <tr><td>INV</td><td>-</td></tr> <tr><td>GRAM</td><td>-</td></tr> <tr><td>VF</td><td><i>fin</i></td></tr> </table>	AUX	-	INV	-	GRAM	-	VF
AUX	-									
INV	-									
GRAM	-									
VF	<i>fin</i>									
		VAL	$\langle [1]NP, [2]ADV_{not} \rangle$							
	SEM	$C_{wide-not}(\mathbf{can})(V')$								
	CNTXT	[SAL-UTT {{SEM V'}}]								

And since this inflectional construction feeds contraction, we produce a construct that licenses a word like the following:

(122)

word FORM	<i><can't></i>							
SYN	CAT	<table border="1"> <tr><td>AUX</td><td>-</td></tr> <tr><td>INV</td><td>-</td></tr> <tr><td>VF</td><td><i>fin</i></td></tr> </table>	AUX	-	INV	-	VF	<i>fin</i>
AUX	-							
INV	-							
VF	<i>fin</i>							
	VAL	$\langle [1]_{3sg}, [2] \rangle$						
SEM	$C_{wide-not}(\mathbf{can})(V')(\mathbf{not})$ $= \mathbf{not}(\mathbf{can}(V'))$							
CNTXT	[SAL-UTT {{SEM V'}}]							

We thus assign the same semantics to *Dominique cannot.* and *Dominique can't,* as desired.

The grammar also licenses a word just like the one in (122), but with positive specifications for AUX and INV (since *can* is an auxiliary verb, nothing forces the negative specifications). This allows contracted forms to appear in aux-initial constructs, whether their complements have undergone PAE or not, as in (123):

- (123) a. Why can't Dominique come along?
 b. I'm getting an HPV vaccination; shouldn't you __ ?
 c. Why didn't they __ ?

Finally, note that PAE preserves the scope restrictions that are controlled by

the negation constructions. That is, examples like (124a,b) are scopally restricted as indicated:

- (124) a. Chris can't __ .
 ('It's false that Chris can __')
- b. You mustn't __ .
 ('You must refrain __')

This follows because the elliptical sentences are constructed according to the same scope constraints as nonelliptical sentences.

8. REBUTTAL

The last auxiliary-sensitive phenomenon to be discussed here is what we've called 'rebuttal', since it allows speakers to counter some point that has been made by the addressee in the salient discourse context. We will assume that the following expressions are functionally equivalent in American English:

- (125) a. We will *só* attend the convention
 b. We will *tóo* attend the convention.
 c. We *wíll* attend the convention.

In addition to conveying the proposition that some contextually appropriate group including the speaker agrees to attend some convention that is under discussion, someone who utters (125a-c) also conveys that in so doing (s)he is somehow rebutting a claim that has just been made. The most likely choice for this claim perhaps is some interlocutor's assertion or suggestion in the immediately prior discourse that the aforementioned group of individuals would not attend the convention. Perhaps *so* and *too* require a more direct connection between the rebuttal and the rebutted claim than mere focal accent does. Nonetheless, we will treat all three of the rebuttal mechanisms in (125) as variants of a single phenomenon, leaving it to subsequent research to provide a more subtle treatment of the pragmatic differences.^[51]

- (126) A: Kim won't read it.
 B: Kim will *tóo/só* read it.

As noted by Jackendoff (1972), the potential for rebuttal ('reaffirmation', in his terms) is a special property of accented auxiliaries, one that distinguishes them from accented nonauxiliary verbs. The rebuttal particles are always accented and combine only with auxiliary verbs:

[51] *So* and *too* occur almost exclusively in American varieties, it seems. *Indeed* is the parallel form in British English, though it occurs in American varieties, as well:

(i) [£] Lee will INDEED eat apples/*Kim eats INDEED apples.

- (127) a. *Kim will tōo/sō read that book.
 b. *Kim read too/so that book.

The analysis is based on a single postlexical construction, as sketched in (128), which yields a finite, uninvertible, unembeddable^[52] verb underspecified for AUX:

(128) **Rebuttal Construction:** (\uparrow *postlex-cxt*)

$$\begin{array}{l}
 \text{rebuttal-cxt} \Rightarrow \\
 \left[\begin{array}{l}
 \text{MTR} \left[\begin{array}{l}
 \text{FORM} \langle F_{\text{Rebut}}(Y) \rangle \\
 \text{SYN} X ! \left[\text{CAT} \left[\text{AUX} \textit{bool} \right] \right] \\
 \text{SEM} Z \bullet \text{Rebut}(\mathbf{s}, \mathbf{a}, \mathbf{m}) \\
 \text{CNTXT} \left[\begin{array}{l}
 \text{ADDR} \quad \mathbf{a} \\
 \text{SPKR} \quad \mathbf{s} \\
 \text{LATEST-MOVE} \quad \mathbf{m}
 \end{array} \right]
 \end{array} \right] \\
 \text{DTRS} \left\langle \left[\begin{array}{l}
 \text{FORM} \langle Y \rangle \\
 \text{SYN} X : \left[\text{CAT} \left[\begin{array}{l}
 \text{AUX} \quad + \\
 \text{IC} \quad + \\
 \text{INV} \quad - \\
 \text{VF} \quad \textit{fin}
 \end{array} \right] \right] \right\rangle \\
 \text{SEM} Z
 \end{array} \right]
 \end{array}
 \right.
 \end{array}$$

where

1. If $Y = F_{\text{contr}}(K)$, then $F_{\text{Rebut}}(Y) = \acute{Y}$
2. Otherwise, $F_{\text{Rebut}}(Y) = \acute{Y}, Y + \textit{too}$, or $Y + \textit{so}$.

Put informally, the rebuttal form is achieved strictly by focal accent if the verb is contracted, and achieved via *too*, *so* or focal accent otherwise. Here ‘•’ is a composition operator functioning as ‘expressive glue’ (Potts 2003). Making reference to elements of the context of utterance, it introduces the act of rebuttal in an independent dimension – a parallel channel of communication. As intended, [INV –] ensures that the rebutting verb projects a noninverted clause:

- (129) a. *Did Kim so leave!
 b. Kim did so leave!

In the simplest case, this analysis will license words like the following:

[52] Recall from section 2 that the specification [IC +] restricts verbs to root clauses.

- (130) a.

FORM	⟨ <i>will+so</i> ⟩										
SYN	CAT	<table border="1" style="border-collapse: collapse; text-align: center;"> <tr><td style="padding: 2px;">VF</td><td style="padding: 2px;"><i>fin</i></td></tr> <tr><td style="padding: 2px;">AUX</td><td style="padding: 2px;">-</td></tr> <tr><td style="padding: 2px;">INV</td><td style="padding: 2px;">-</td></tr> <tr><td style="padding: 2px;">GRAM</td><td style="padding: 2px;">-</td></tr> </table>	VF	<i>fin</i>	AUX	-	INV	-	GRAM	-	
VF	<i>fin</i>										
AUX	-										
INV	-										
GRAM	-										
VAL		[̄]⟨NP, VP[<i>base</i>]⟩									
SEM Z • Rebut(s,a,m)											
CNTXT		ADDR	a								
		SPKR	s								
		LATEST-MOVE	m								
- b.

FORM	⟨ <i>will</i> ⟩										
SYN	CAT	<table border="1" style="border-collapse: collapse; text-align: center;"> <tr><td style="padding: 2px;">VF</td><td style="padding: 2px;"><i>fin</i></td></tr> <tr><td style="padding: 2px;">AUX</td><td style="padding: 2px;">-</td></tr> <tr><td style="padding: 2px;">INV</td><td style="padding: 2px;">-</td></tr> <tr><td style="padding: 2px;">GRAM</td><td style="padding: 2px;">-</td></tr> </table>	VF	<i>fin</i>	AUX	-	INV	-	GRAM	-	
VF	<i>fin</i>										
AUX	-										
INV	-										
GRAM	-										
VAL		[̄]⟨NP, VP[<i>base</i>]⟩									
SEM Z • Rebut(s,a,m)											
CNTXT		ADDR	a								
		SPKR	s								
		LATEST-MOVE	m								

These words can be used to rebut the latest move in the CNTXT value (on the ‘Dialogue-Game-Board’ in the sense of Ginzburg (2012)) when that is consistent with asserting the content of the sentence the verb projects.

As a final, subtle prediction of our analysis of Rebuttal, consider the following data set discussed by Embick & Noyer (2001):

- (131) a. *You always not do that.
 cf. You can always not do that.
 b. *You dǒ always not do that.
 c. You dó always not do that.

Embick and Noyer sketch the beginnings of an analysis based on the idea that putative ineffability here is created by constituent negation, which suffices to block affix lowering, but is not enough to trigger the transformation of *Do*-Support.

However, these facts follow to the letter from independently motivated aspects of our analysis. For example, (131a) is ungrammatical because *not* illegally precedes the (indicative) finite form *do*. One might think that *do* is a nonfinite form, but then the sentence would be ill-formed because it lacked a finite verbal head. The unaccented auxiliary *do* in (131b) must be [AUX -] because of the Subject-Predicate Construction, but the lexeme for auxiliary *do* is lexically specified as [AUX +], which is incompatible with such a requirement. Finally, the verb heading (131c) is the rebuttal form of auxiliary *do*, which, as we have just

seen, can be [AUX –]. Its VP complement is *always not do that*, whose head is the nonauxiliary verb *do*. All is as it should be in (131).

As in other SAI phenomena, the present account can handle subtle exceptional cases. For example, for some speakers, the negated permissive *may* form is exceptional in that it necessarily has rebuttal force:

(132) “May I sit down?” “No,” Borowitz growled, “you may not”.

This can be accounted for if the form *may not* is explicitly listed in the lexicon with rebuttal force, rather than being derived through negation and rebuttal rules.

9. CONCLUSION

The English auxiliary system exhibits many lexical exceptions and subregularities, and considerable dialectal variation. The idiosyncrasies range from families of similar, but semantically distinct inversion constructions, to auxiliary verbs with peculiar constructional distributions and distinct interactions with negation. Such idiosyncrasies, commonly omitted from generative analyses and discussions, as well as the general principles that govern both aux-related and non-aux constructions, can be accommodated within constructional grammar. The analysis of the English auxiliary system sketched in the present work involves a small inventory of language-particular constructions, appropriately constrained, which express the well-known generalizations about auxiliary constructions, as well as the often-ignored cases of lexical idiosyncrasy, including the distribution of the auxiliary *do*. In particular, under these constructional assumptions, the auxiliary verb *do* is readily analyzed without appeal to a *Do*-Support transformation, or to nonmonotonic principles of optimization.

In the present theory clauses are required to be headed by a finite verb, which may be an auxiliary verb or a nonauxiliary verb. Auxiliaries precede any lexical verbs because some auxiliaries have only finite lexical forms and hence must precede all other verbs they subcategorize for, and the strict ordering of auxiliary elements follows from semantic constraints and/or feature incompatibilities. Auxiliaries determine the form of the following verb, and thus such constraints are enforced by lexical selection, without anything like affix-hopping. Moreover, auxiliary-initial clauses do not require anything like head-movement. Rather, they involve a different (post-verbal) realization of the subject. Unstressed auxiliary *do* is restricted to [AUX +] environments, but when it interacts with NICER constructions it can appear in a wider range of environments, like other auxiliaries.

The present account, compatible in principle with any constraint-based grammatical framework, is cast in terms of a constructional theory of grammar, drawing from a variety of construction-based approaches to grammar. The most conspicuous influences are Head-Driven Phrase Structure Grammar and (Berkeley) Construction Grammar. In addition to its superior treatment of EAS, the present account contains no movement operations, and therefore fits well into a minimalist philosophy of grammar.

The type hierarchy (partial):

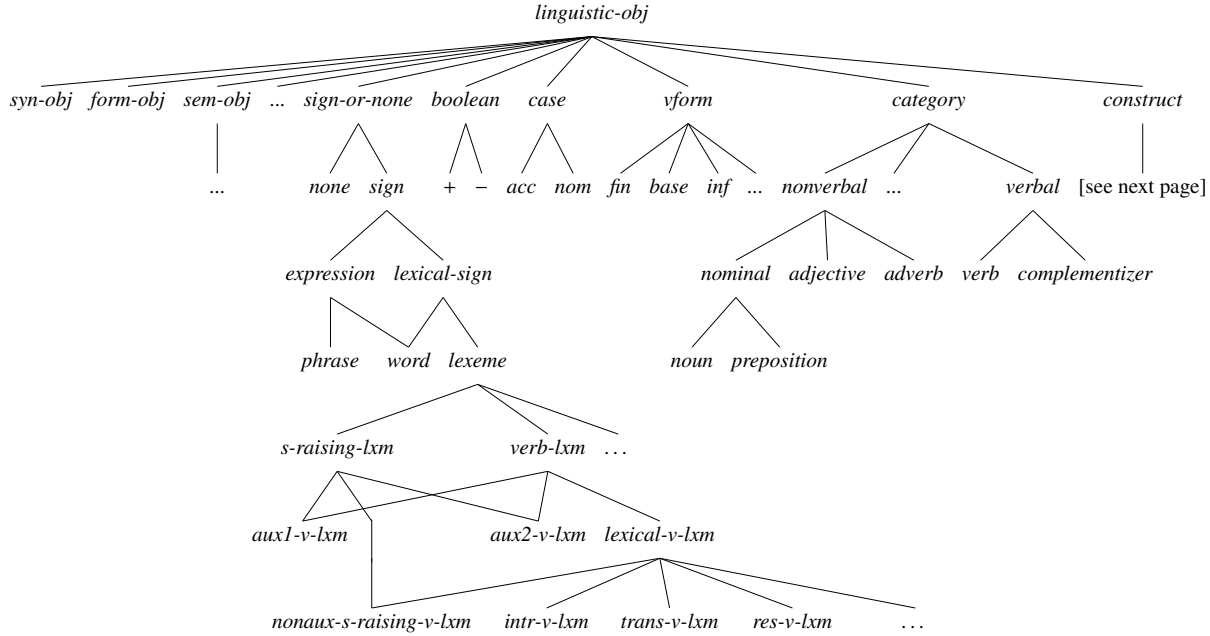

The construct type hierarchy (partial):

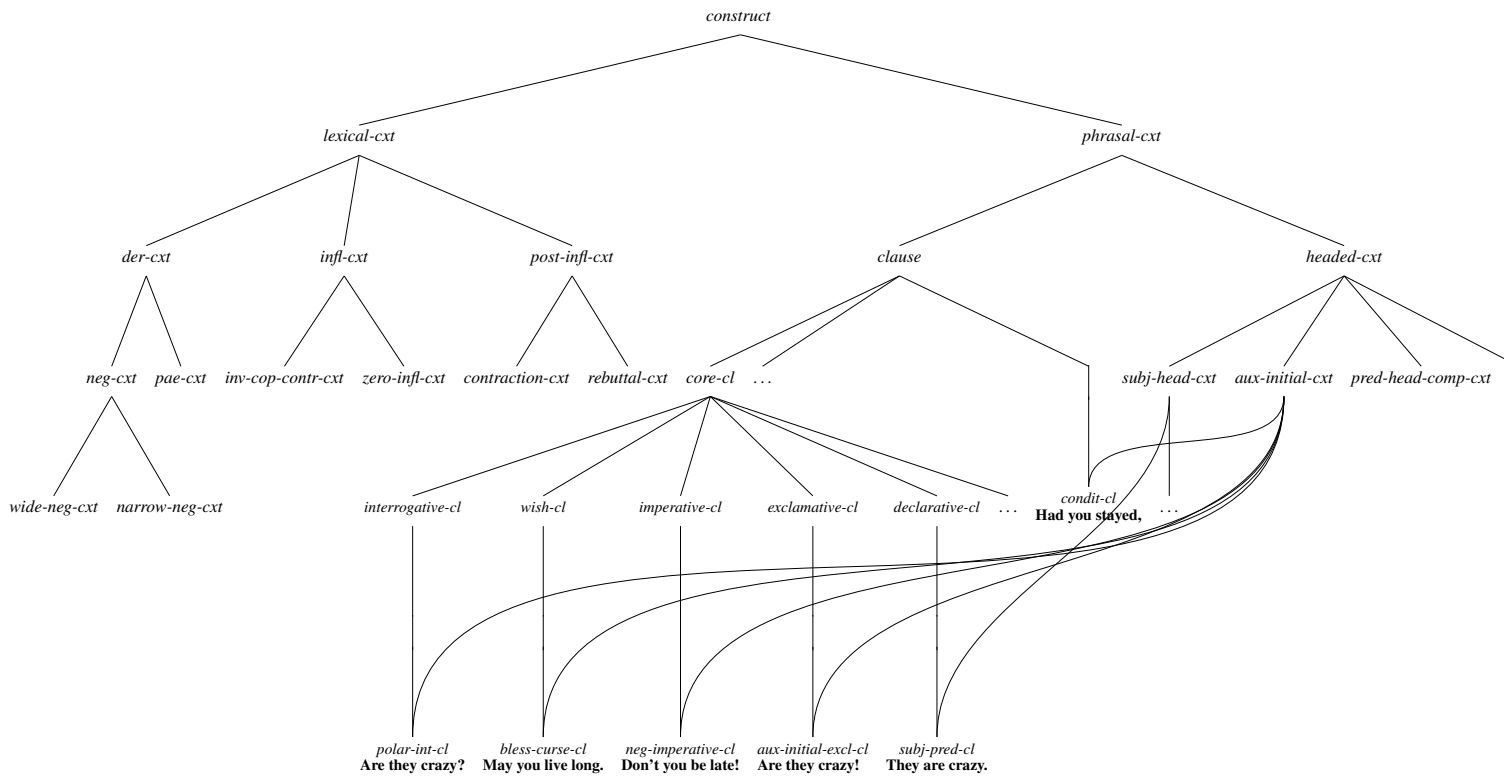

Grammar Signature: Some Type Declarations

$$\text{sign} : \begin{bmatrix} \text{PHON} & \text{phon-obj} \\ \text{FORM} & \text{form-obj} \\ \text{SYN} & \text{syn-obj} \\ \text{SEM} & \text{sem-obj} \\ \text{CNTXT} & \text{cntx-obj} \end{bmatrix}$$

$$\text{syn-obj} : \begin{bmatrix} \text{CAT} & \text{category} \\ \text{VAL} & \text{list(expression)} \\ \text{GAP} & \text{list(expression)} \end{bmatrix}$$

$$\text{construct} : \begin{bmatrix} \text{MTR} & \text{sign} \\ \text{DTRS} & \text{nelist(sign)} \end{bmatrix}$$

$$\text{lex-cxt} : \begin{bmatrix} \text{MTR} & \text{lexical-sign} \\ \text{DTRS} & \text{nelist(lex-sign)} \end{bmatrix}$$

$$\text{infl-cxt} : \begin{bmatrix} \text{MTR} & \text{word} \\ \text{DTRS} & \text{nelist(lexeme)} \end{bmatrix}$$

$$\text{post-infl-cxt} : \begin{bmatrix} \text{MTR} & \text{word} \\ \text{DTRS} & \text{nelist(word)} \end{bmatrix}$$

$$\text{der-cxt} : \begin{bmatrix} \text{MTR} & \text{lexeme} \\ \text{DTRS} & \text{nelist(lexeme)} \end{bmatrix}$$

$$\text{phrasal-cxt} : \begin{bmatrix} \text{MTR} & \text{phrase} \\ \text{DTRS} & \text{nelist(expression)} \end{bmatrix}$$

$$\text{verbal} : \begin{bmatrix} \text{VF} & \text{vform} \\ \text{IC} & \text{boolean} \end{bmatrix}$$

$$\text{verb} : \begin{bmatrix} \text{AUX} & \text{boolean} \\ \text{INV} & \text{boolean} \\ \text{GRAM} & \text{boolean} \end{bmatrix}$$

$$\text{noun} : \begin{bmatrix} \text{CASE} & \text{case} \end{bmatrix}$$

Some lexical class constructions (verbs):

$$\text{verb-lxm} \Rightarrow \left[\text{SYN} \begin{bmatrix} \text{CAT} & [\text{verb}] \\ \text{VAL} & \langle X, \dots \rangle \end{bmatrix} \right]$$

$$\text{lexical-v-lxm} \Rightarrow \left[\text{SYN} \begin{bmatrix} \text{CAT} & \begin{bmatrix} \text{AUX} & - \\ \text{INV} & - \\ \text{GRAM} & - \end{bmatrix} \end{bmatrix} \right]$$

$$\text{s-raising-v-lxm} \Rightarrow \left[\text{VAL} \langle X, [\text{VAL} \langle X \rangle] \rangle \right]$$

$$\text{intr-v-lxm} \Rightarrow \left[\text{VAL} \langle X \rangle \right]$$

Some Auxiliary Listemes:

$$\begin{bmatrix} \text{auxI-v-lxm} \\ \text{FORM} & \langle \text{can} \rangle \\ \text{SYN} & \begin{bmatrix} \text{CAT} & \begin{bmatrix} \text{VF} & \text{fin} \\ \text{GRAM} & - \end{bmatrix} \\ \text{VAL} & \langle X, [\text{VF base}] \rangle \end{bmatrix} \\ \text{SEM} & \text{can} \end{bmatrix}$$

$$\begin{bmatrix} \text{auxI-v-lxm} \\ \text{FORM} & \langle \text{do} \rangle \\ \text{SYN} & \begin{bmatrix} \text{CAT} & \begin{bmatrix} \text{AUX} & + \\ \text{VF} & \text{fin} \\ \text{GRAM} & + \end{bmatrix} \\ \text{VAL} & \langle X, [\text{VF GRAM base}] \rangle \end{bmatrix} \\ \text{SEM} & \mathbf{F}_{ID} \end{bmatrix}$$

$$\left[\begin{array}{l} \text{aux1-v-lxm} \\ \text{FORM } \langle \text{shall} \rangle \\ \\ \text{SYN} \left[\begin{array}{l} \text{CAT} \left[\begin{array}{l} \text{INV} \quad + \\ \text{VF} \quad \text{fin} \\ \text{GRAM} \quad - \end{array} \right] \\ \text{VAL} \langle X, [\text{VF base}] \rangle \end{array} \right] \\ \\ \text{SEM} \quad \mathbf{SHALL}_{\text{deon}} \end{array} \right]$$

$$\left[\begin{array}{l} \text{aux1-v-lxm} \\ \text{FORM } \langle \text{shall} \rangle \\ \\ \text{SYN} \left[\begin{array}{l} \text{CAT} \left[\begin{array}{l} \text{VF fin} \\ \text{GRAM} \quad - \end{array} \right] \\ \text{VAL} \langle X, [\text{VF base}] \rangle \end{array} \right] \\ \\ \text{SEM} \quad \mathbf{SHALL}_{\text{fut}} \end{array} \right]$$

$$\left[\begin{array}{l} \text{aux1-v-lxm} \\ \text{FORM } \langle \text{will} \rangle \\ \\ \text{SYN} \left[\begin{array}{l} \text{CAT} \left[\begin{array}{l} \text{VF} \quad \text{fin} \\ \text{GRAM} \quad - \end{array} \right] \\ \text{VAL} \langle X, [\text{VF base}] \rangle \end{array} \right] \\ \\ \text{SEM} \quad \mathbf{will} \end{array} \right]$$

$$\left[\begin{array}{l} \text{aux2-v-lxm} \\ \text{FORM } \langle \text{must} \rangle \\ \\ \text{SYN} \left[\begin{array}{l} \text{CAT} \left[\begin{array}{l} \text{VF} \quad \text{fin} \\ \text{GRAM} \quad - \end{array} \right] \\ \text{VAL} \langle X, [\text{VF base}] \rangle \end{array} \right] \\ \\ \text{SEM} \quad \mathbf{must} \end{array} \right]$$

$$\left[\begin{array}{l} \text{aux1-v-lxm} \\ \text{FORM } \langle \text{be} \rangle \\ \\ \text{SYN} \left[\begin{array}{l} \text{CAT} \left[\begin{array}{l} \text{VF} \quad \text{base} \\ \text{GRAM} \quad + \end{array} \right] \\ \text{VAL} \langle X, [\text{PRED} \quad +] \rangle \end{array} \right] \\ \\ \text{SEM} \quad \mathbf{F}_{ID} \end{array} \right]$$

$$\left[\begin{array}{l} \text{aux1-v-lxm} \\ \text{FORM } \langle \text{to} \rangle \\ \\ \text{SYN} \left[\begin{array}{l} \text{CAT} \left[\begin{array}{l} \text{VF} \quad \text{inf} \\ \text{GRAM} \quad - \end{array} \right] \\ \text{VAL} \langle X, [\text{VF base}] \rangle \end{array} \right] \\ \\ \text{SEM} \quad \mathbf{F}_{ID} \end{array} \right]$$

Some Lexical Combinatoric Constructions:

ZERO INFLECTION CONSTRUCTION ($\uparrow \text{infl-cxt}$):

$$\text{zero-infl-cxt} \Rightarrow \left[\begin{array}{l} \text{MTR} \quad X! \text{word} \\ \text{DTRS} \quad X: \text{lexeme} \end{array} \right]$$

NEGATION CONSTRUCTION ($\uparrow \text{der-cxt}$)

$$\text{neg-cxt} \Rightarrow \left[\begin{array}{l} \text{MTR} \left[\begin{array}{l} \text{FORM} \quad Z \\ \text{SYN} \left[\begin{array}{l} \text{CAT} \left[\text{VF fin} \right] \\ \text{VAL} \langle X, \text{ADV}_{\text{not}} \oplus L \rangle \end{array} \right] \end{array} \right] \\ \\ \text{DTRS} \left\langle \left[\begin{array}{l} \text{FORM} \quad Z \\ \text{SYN} \left[\text{VAL} \langle X \oplus L \rangle \right] \end{array} \right] \right\rangle \end{array} \right]$$

WIDE NEGATION CONSTRUCTION ($\uparrow \text{neg-cxt}$)

$$\text{wide-neg-cxt} \Rightarrow \left[\begin{array}{l} \text{MTR} \left[\text{SEM} \quad \mathbf{C}_{\text{wide-not}}(\mathbf{V}) \right] \\ \text{DTRS} \left\langle \left[\begin{array}{l} \text{aux1-v-lxm} \\ \text{SEM} \quad \mathbf{V} \end{array} \right] \right\rangle \end{array} \right]$$

NARROW NEGATION CONSTRUCTION ($\uparrow \text{neg-cxt}$)

$$\text{narrow-neg-cxt} \Rightarrow \left[\begin{array}{l} \text{MTR} \left[\text{SEM} \quad \mathbf{C}_{\text{narrow-not}}(\mathbf{V}) \right] \\ \text{DTRS} \left\langle \left[\begin{array}{l} \text{aux2-v-lxm} \\ \text{SEM} \quad \mathbf{V} \end{array} \right] \right\rangle \end{array} \right]$$

INVERTED COPULAR CONTRACTION CONSTRUCTION ($\uparrow infl\text{-}cxt$)

$$inv\text{-}cop\text{-}contr\text{-}cxt \Rightarrow \left[\begin{array}{l} \text{MTR} \left[\begin{array}{l} \text{FORM} \langle aren't \rangle \\ \text{SYN} \left[\begin{array}{l} \text{CAT} \left[\begin{array}{l} \text{INV} + \\ \text{VAL} \langle X_{Isg} \rangle \oplus L \end{array} \right] \\ \text{SEM} Y \end{array} \right] \end{array} \right] \\ \text{DTRS} \left\langle \left[\begin{array}{l} \text{FORM} \langle be \rangle \\ \text{CAT} \left[\begin{array}{l} \text{VAL} \langle X \rangle \oplus L \end{array} \right] \\ \text{SEM} Y \end{array} \right] \right\rangle \end{array} \right]$$

CONTRACTION CONSTRUCTION ($\uparrow post\text{-}infl\text{-}cxt$)

$$contraction\text{-}cxt \Rightarrow \left[\begin{array}{l} \text{MTR} \left[\begin{array}{l} \text{FORM} \langle F_{Contr}(Y) \rangle \\ \text{SYN} \left[\begin{array}{l} \text{CAT} U ! [AUX \textit{bool}] \\ \text{VAL} \langle X \rangle \oplus L \end{array} \right] \\ \text{SEM} Z(\textit{not}) \end{array} \right] \\ \text{DTRS} \left\langle \left[\begin{array}{l} \text{FORM} \langle Y \rangle \\ \text{SYN} \left[\begin{array}{l} \text{CAT} U; [AUX +] \\ \text{VAL} \langle X, ADV_{not} \rangle \oplus L \end{array} \right] \\ \text{SEM} Z \end{array} \right] \right\rangle \end{array} \right]$$

REBUTTAL CONSTRUCTION ($\uparrow post\text{-}infl\text{-}cxt$)

$$rebuttal\text{-}cxt \Rightarrow \left[\begin{array}{l} \text{MTR} \left[\begin{array}{l} \text{FORM} \langle F_{Rebut}(Y) \rangle \\ \text{SYN} X ! \left[\begin{array}{l} \text{CAT} [AUX \textit{bool}] \end{array} \right] \\ \text{SEM} Z \bullet \textit{Rebut}(s, a, m) \\ \text{CNTXT} \left[\begin{array}{l} \text{ADDR} \quad \mathbf{a} \\ \text{SPKR} \quad \mathbf{s} \\ \text{LATEST-MOVE} \quad \mathbf{m} \end{array} \right] \end{array} \right] \\ \text{DTRS} \left\langle \left[\begin{array}{l} \text{FORM} \langle Y \rangle \\ \text{SYN} X : \left[\begin{array}{l} \text{CAT} \left[\begin{array}{l} \text{AUX} + \\ \text{IC} + \\ \text{INV} - \\ \text{VF} \textit{fin} \end{array} \right] \end{array} \right] \\ \text{SEM} Z \end{array} \right] \right\rangle \end{array} \right]$$

where

1. If $Y = F_{contr}(Z)$, then $F_{Rebut}(Y) = \acute{Y}$
2. Otherwise, $F_{Rebut}(Y) = \acute{Y}$, $Y + too$, or $Y + so$.

POST-AUXILIARY ELLIPSIS ($\uparrow der\text{-}cxt$)

$$pae\text{-}cxt \Rightarrow \left[\begin{array}{l} \text{MTR} \left[\begin{array}{l} \text{FORM } Y \\ \text{SYN} \left[\begin{array}{l} \text{CAT } U ! [\text{AUX } bool] \\ \text{VAL } L_{ne\text{-}list} \end{array} \right] \\ \text{SEM } Z(\mathbf{V}') \\ \text{CNTXT} [\text{SAL-UTT } \{[\text{SEM } \mathbf{V}'], \dots\}] \end{array} \right] \\ \text{DTRS} \left\langle \left[\begin{array}{l} \text{FORM } Y \\ \text{SYN} \left[\begin{array}{l} \text{CAT } U : [\text{AUX } +] \\ \text{VAL } L \oplus \langle X \rangle \end{array} \right] \\ \text{SEM } Z \end{array} \right] \right\rangle \end{array} \right]$$

Some Phrasal Combinatoric Constructions:SUBJECT-HEAD CONSTRUCTION ($\uparrow headed\text{-}cxt$):

$$subject\text{-}head\text{-}cxt \Rightarrow \left[\begin{array}{l} \text{MTR} \left[\text{SYN} \left[\begin{array}{l} \text{CAT } H \\ \text{VAL } \langle \rangle \end{array} \right] \right] \\ \text{DTRS} \left\langle Z, \left[\text{SYN} \left[\begin{array}{l} \text{CAT } H : \left[\begin{array}{l} \text{AUX } - \\ \text{INV } - \end{array} \right] \\ \text{VAL } \langle Z \rangle \end{array} \right] \right] \right\rangle \end{array} \right]$$

SUBJECT-PREDICATE CONSTRUCTION ($\uparrow subject\text{-}head\text{-}cxt$ & $\uparrow declarative\text{-}cl$):

$$subj\text{-}pred\text{-}cl \Rightarrow \left[\begin{array}{l} \text{MTR} [\text{SEM } \mathbf{Y}(\mathbf{X})] \\ \text{DTRS} \left\langle [\text{SEM } \mathbf{X}], \left[\text{SYN} \left[\begin{array}{l} \text{CAT } [\text{VF } fn] \\ \text{SEM } \mathbf{Y} \end{array} \right] \right] \right\rangle \end{array} \right]$$

PREDICATIONAL HEAD-COMPLEMENT CONSTRUCTION ($\uparrow headed\text{-}cxt$):

$$pred\text{-}hd\text{-}comp\text{-}cxt \Rightarrow \left[\begin{array}{l} \text{MTR} \left[\begin{array}{l} \text{SYN } X ! [\text{VAL } \langle Y \rangle] \\ \text{SEM } \mathbf{F}(\mathbf{X}_1), \dots, (\mathbf{X}_n) \end{array} \right] \\ \text{DTRS} \left\langle \left[\text{SYN } X : \left[\begin{array}{l} \text{CAT} \left[\begin{array}{l} \text{AUX } - \\ \text{INV } - \end{array} \right] \\ \text{VAL } \langle Y \rangle \oplus L : \langle [\text{SEM } \mathbf{X}_1], \dots, [\text{SEM } \mathbf{X}_n] \rangle \end{array} \right] \right] \right\rangle \oplus L \\ \text{SEM } \mathbf{F} \end{array} \right]$$

AUX-INITIAL CONSTRUCTION ($\uparrow headed\text{-}cxt$):

$$aux\text{-}initial\text{-}cxt \Rightarrow \left[\begin{array}{l} \text{MTR} [\text{SYN } X ! [\text{VAL } \langle \rangle]] \\ \text{DTRS} \left\langle \left[\begin{array}{l} \text{word} \\ \text{SYN } X : \left[\begin{array}{l} \text{CAT} [\text{INV } +] \\ \text{VAL } L : \text{nelist} \end{array} \right] \end{array} \right] \right\rangle \oplus L \end{array} \right]$$

POLAR INTERROGATIVE CONSTRUCTION ($\uparrow aux\text{-}initial\text{-}cxt$ & $\uparrow interrogative\text{-}cl$):

$$polar\text{-}int\text{-}cl \Rightarrow \left[\begin{array}{l} \text{MTR} \left[\begin{array}{l} \text{SYN} [\text{CAT } [\text{IC } +]] \\ \text{SEM } \lambda \{ \} [\mathbf{FR}(\mathbf{V}_1, \dots, \mathbf{V}_n)] \end{array} \right] \\ \text{DTRS} \left\langle [\text{SEM } \mathbf{V}_1], \dots, [\text{SEM } \mathbf{V}_n] \right\rangle \end{array} \right]$$

INVERTED EXCLAMATIVE CONSTRUCTION (\uparrow aux-initial-cxt & \uparrow exclamative-cl):

$$\text{aux-initial-excl-cl} \Rightarrow \left[\begin{array}{l} \text{MTR} \left[\begin{array}{l} \text{SYN} [\text{CAT} [\text{IC} +]] \\ \text{SEM} \text{fact}(\mathbf{FR}(\mathbf{V}_1, \dots, \mathbf{V}_n)) \end{array} \right] \\ \text{DTRS} \left\langle \left[\text{SEM} \mathbf{V}_1 \right], \dots, \left[\text{SEM} \mathbf{V}_n \right] \right\rangle \end{array} \right]$$

REFERENCES

- Akmajian, Adrian. 1984. Sentence types and the form-function fit. *Natural Language and Linguistic Theory* 2. 1–24.
- Akmajian, Adrian & Thomas Wasow. 1975. The constituent structure of vp and aux and the position of the verb be. *Linguistic Analysis* 1. 205–245.
- Ambidge, Ben, Caroline Rowland & Julian Pine. 2008. Is structure dependence an innate constraint? new experimental evidence from childrens complex-question production. *Cognitive Science* 32. 222–255.
- Arnold, Doug & Robert D. Borsley. 2010. Auxiliary-stranding relative clauses. In Stefan Müller (ed.), *Proceedings of the hpsg-2010 conference*, 4767. Stanford: CSLI Publications.
- Baker, Carl Lee. 1989. *English syntax*. Cambridge, Mass: MIT Press.
- Bender, Emily & Daniel P. Flickinger. 1999. Peripheral constructions and core phenomena: Agreement in tag questions. In Gert Webelhuth, Jean-Pierre Koenig & Andreas Kathol (eds.), *Lexical and constructional aspects of linguistic explanation*, 199–214. Stanford: CSLI Publications.
- Berwick, Robert C. & Noam Chomsky. 2008. ‘poverty of the stimulus’ revisited: Recent challenges reconsidered. In *30th annual meeting of the cognitive science society*, .
- Berwick, Robert C., Paul Pietroski, Beracah Yankama & Noam Chomsky. 2011. Poverty of the stimulus revisited. *Cognitive Science* 35. 1207–1242.
- Binnick, Robert I. 1991. *Time and the verb: a guide to tense and aspect*. New York and Oxford: Oxford University Press.
- Boas, Hans C. & Ivan A. Sag (eds.). 2012. *Sign-based construction grammar*. Stanford: CSLI Publications.
- Bod, Rens. 2009. From exemplar to grammar: A probabilistic analogy-based model of language learning. *Cognitive Science* 33(5). 752–793.
- Borsley, Robert D. & Frederick J. Newmeyer. 2009. On subject-auxiliary inversion and the notion ‘purely formal generalization’. *Cognitive Linguistics* 20(1). 135–143.
- Bresnan, Joan. 2000. Optimal syntax. In Joost Dekkers, Frank van der Leeuw & Jeroen van de Weijer (eds.), *Optimality theory: Phonology, syntax and acquisition*, Oxford: Oxford University Press.
- Bresnan, Joan W. 2001. *Lexical-functional syntax*. Oxford: Basil Blackwell’s.
- Brew, Chris. 1995. Stochastic HPSG. In *Proceedings of the 7th conference of the EACL*, Dublin.
- Briscoe, Ted & Ann Copestake. 1999. Lexical rules in constraint-based grammar. *Computational Linguistics* 4(25). 487–526.
- Carpenter, Patricia A., Marcel Adam Just, Timothy A. Keller, William F. Eddy & Keith R. Thulborn. 1999. Time course of fmri-activation in language and spatial networks during sentence comprehension. *NeuroImage* 10. 216–224.
- Chomsky, Noam. 1955. The logical structure of linguistic theory. Ms., Society of Fellows, Harvard University. Published in 1975 as *The Logical Structure of Linguistic Theory* by Plenum. Now available from the University of Chicago Press, Chicago, Illinois.
- Chomsky, Noam. 1956. Three models for the description of language. *IRE Transactions in Information Theory* 2. 113–124.
- Chomsky, Noam. 1981. *Lectures on government and binding*. Dordrecht: Foris.
- Chomsky, Noam. 1993. A minimalist program for linguistic theory. In Ken Hale & Samuel J. Keyser (eds.), *The view from building 20*, 1–52. Cambridge, MA: MIT Press.
- Chomsky, Noam. 2010. Restricting stipulations: Consequences and challenges. Talk given at the Universitt Stuttgart, March 24th.
- Clark, Alexander & Rémi Eyrraud. 2006. Learning auxiliary fronting with grammatical inference. In *Proceedings of the tenth conference on computational natural language learning CoNLL-X ’06*, 125–132. Stroudsburg, PA, USA: Association for Computational Linguistics.
- Clark, Alexander & Shalom Lappin. 2011. *Linguistic nativism and the poverty of the stimulus*. Wiley-Blackwell, Oxford.

- Crain, Stephen & Mineharu Nakayama. 1987. Structure dependence in grammar formation. *Language* 63(3). 522–543.
- Culicover, Peter. 1971. *Syntactic and semantic investigations*: MIT dissertation.
- Culicover, Peter & Ray Jackendoff. 2005. *Simpler syntax*. Oxford: Oxford University Press.
- Di Sciullo, Anna Marie & Edwin Williams. 1987. *On the definition of word*. Cambridge, MA: MIT Press.
- Donohue, Cathryn & Ivan A. Sag. 1999. Domains in Warlpiri. In *Sixth international conference on HPSG—abstracts. 04–06 august 1999*, 101–106. Edinburgh.
- Embick, David & Rolf Noyer. 2001. Movement operations after syntax. *Linguistic Inquiry* 32(4). 555–595.
- Estigarribia, Bruno. 2007. *Asking questions: language variation and language acquisition*: Stanford University Phd dissertation.
- Estigarribia, Bruno. 2010. Facilitation by variation: Right-to-left learning of english yes/no questions. *Cognitive Science* 34(1). 68–93.
- Eynde, Frank Van. 2015. *Predicative constructions: from the fregean to a montagovian treatment*. CSLI Publications, Stanford.
- Falk, Yehuda N. 1984. The english auxiliary system: A lexical-functional analysis. *Language* 60. 483–509.
- Falk, Yehuda N. 2003. The english auxiliary system revisited. In Miriam Butt & Tracy Holloway King (eds.), *Proceedings of the lfg03 conference*, 184–204.
- Fillmore, Charles J. 1999. Inversion and constructional inheritance. In Gert Webelhuth, Jean-Pierre Koenig & Andreas Kathol (eds.), *Lexical and constructional aspects of linguistic explanation Studies in Constraint-Based Lexicalism*, chap. 21, 113–128. Stanford: CSLI Publications.
- Fillmore, Charles J., Paul Kay & Mary C. O'Connor. 1988. Regularity and idiomaticity in grammatical constructions: The case of *let alone*. *Language* 64. 501–538.
- Flickinger, Daniel P. 1987. *Lexical rules in the hierarchical lexicon*: Stanford University dissertation.
- Flickinger, Daniel P., Carl J. Pollard & Thomas Wasow. 1985. A computational semantics for natural language. In *Proceedings of the twenty-third annual meeting of the acl*, 262–267. Chicago, IL: ACL.
- Fodor, Janet Dean, Thomas G. Bever & Merrill F. Garrett. 1974. *The psychology of language*. New York: McGraw Hill.
- Freidin, Robert. 2004. Syntactic structures redux. *Syntax* 2(7). 101–127.
- Gazdar, Gerald, Ewan Klein, Geoffrey K. Pullum & Ivan A. Sag. 1985. *Generalized phrase structure grammar*. Oxford: Basil Blackwell's and Cambridge, MA: Harvard University Press.
- Gazdar, Gerald & Geoffrey K. Pullum. 1981. Subcategorization, constituent order and the notion of "head". In Michael Moortgat, Harry van der Hulst & Teun Hoekstra (eds.), *The scope of lexical rules*, 107–123. Dordrecht: Foris.
- Gazdar, Gerald, Geoffrey K. Pullum & Ivan A. Sag. 1982. Auxiliaries and related phenomena in a restricted theory of grammar. *Language* 58. 591–638.
- Ginzburg, Jonathan. 2012. *The interactive stance: Meaning for conversation*. Oxford: Oxford University Press.
- Ginzburg, Jonathan & Ivan A. Sag. 2000. *Interrogative investigations: The form, meaning, and use of english interrogatives*. Stanford, California: CSLI Publications.
- Goldberg, Adele. 1995. *Constructions: A construction grammar approach to argument structure*. Chicago: University of Chicago Press.
- Goldberg, Adele. 2006. *Constructions at work: The nature of generalization in language*. Oxford: Oxford University Press.
- Goldberg, Adele E. 2009. Constructions work. *Cognitive Linguistics* 20(1). 201–224.
- Grice, Paul H. 1975. Logic and conversation. In P. Cole & J. Morgan (eds.), *Syntax and semantics*, vol.3, Academic Press.
- Grimshaw, Jane. 1997. Projections, heads, and optimality. *Linguistic Inquiry* 28. 373–422.
- Haegeman, Liliane. 1991. *Introduction to government and binding theory*. Oxford: Blackwell.
- Hankamer, Jorge. 1978. On the non-transformational derivations of some null NP anaphors. *Linguistic Inquiry* 9. 55–74.
- Hankamer, Jorge & Ivan A. Sag. 1976. Deep and surface anaphora. *Linguistic Inquiry* 7. 391–426.
- Horn, Laurence. 1972. *On the semantic properties of logical operators in english*: UCLA, Los Angeles Ph.d. thesis.
- Horn, Laurence R. 1989. *A Natural History of Negation*. Chicago: University of Chicago Press.

- Huddleston, Rodney. 1976. Some theoretical issues in the description of the English verb. *Lingua* 40. 331–383.
- Huddleston, Rodney D. & Geoffrey K. Pullum. 2002. *The Cambridge grammar of the English language*. Cambridge: Cambridge University Press.
- Hudson, Richard. 1976a. *Arguments for a non-transformational grammar*. Chicago: University of Chicago Press.
- Hudson, Richard. 1976b. *Arguments for a non-transformational grammar*. University of Chicago Press.
- Hudson, Richard. 1977. The power of morphological rules. *Lingua* (42). 73–89.
- Hudson, Richard. 1990. *English word grammar*. Oxford: Blackwell.
- Hudson, Richard. 2000a. Grammar without functional categories. In Robert Borsley (ed.), *The nature and function of syntactic categories*, 7–35. New York: Academic Press.
- Hudson, Richard. 2000b. *I amn't. *Language* 76. 297–323.
- Jackendoff, Ray. 1972. *Semantic interpretation in generative grammar*. Cambridge, MA: MIT Press.
- Jacobson, Pauline. 2008. Direct compositionality and variable free semantics: the case of antecedent contained ellipsis. In Kyle Johnson (ed.), *Topics in ellipsis*, 30–68. Cambridge University Press.
- Jaeger, Florian T. & Thomas Wasow. 2005. Production-complexity driven variation: Relativizer omission in non-subject-extracted relative clauses. In *The 18th cuny sentence processing conference, tucson, az.*
- Johnson, David & Shalom Lappin. 1999. *Local constraints vs economy* Stanford Monographs in Linguistics. Stanford: CSLI Publications.
- Kaplan, Ronald M. & Joan Bresnan. 1982. Lexical-functional grammar: A formal system for grammatical representation. In Joan Bresnan (ed.), *The mental representation of grammatical relations*, 173–281. MIT Press. Reprinted in Mary Dalrymple, Ronald Kaplan, John Maxwell, and Annie Zaenen, eds., *Formal Issues in Lexical-Functional Grammar*. Stanford: CSLI Publications. Pages 29–130.
- Kathol, Andreas. 1995. *Linearization-based German syntax*: Ohio State University dissertation.
- Kathol, Andreas. 2000. *Linear syntax*. New York, Oxford: Oxford University Press.
- Kay, Paul & Charles Fillmore. 1999. Grammatical constructions and linguistic generalizations: The *what's x doing y?* construction. *Language* 75.1. 1–33.
- Kertz, Laura. 2010. *Ellipsis reconsidered*: University of California, San Diego Dissertation.
- Kim, Christina S., Gregory M. Kobele, Jeffrey T. Runner & John T. Hale. 2011. The acceptability cline VP Ellipsis. *Syntax* 14(4). 318–354.
- Kim, Jong-Bok. 2000. *The grammar of negation: A constraint-based approach*. Stanford, CA: CSLI Publications.
- Kim, Jong-Bok & Ivan A. Sag. 2002. French and English negation without head-movement. *Natural Language and Linguistic Theory* 20(2). 339–412.
- Klein, Ewan & Ivan A. Sag. 1985. Type-driven translation. *Linguistics and Philosophy* 8. 163–201.
- Klemola, Juhani. 1998. Semantics of *do* in southwestern dialects of English. In Ingrid Tieken-Boon van Ostade, Marijke van der Wal & Arjan van Leuvensteijn (eds.), *DO in English, Dutch and German: History and present-day variation* (Tübinger Beiträge zur Linguistik 491), 25–51. Münster: Nodus Publikationen.
- Klima, Edward S. 1964. Negation in English. In Jerry A. Fodor & Jerrold J. Katz (eds.), *The structure of language: Readings in the philosophy of language*, 246–323. Prentice Hall.
- Konieczny, Lars. 1996. *Human sentence processing: A semantics-oriented parsing approach*: University of Freiburg Phd dissertation.
- Lambrech, Knud. 1990. What, me, worry?: Mad magazine sentences revisited. In *Proceedings of the sixteenth annual meeting of the Berkeley Linguistics Society*, 215–228.
- Lasnik, Howard. 1995. Verbal morphology: Syntactic structures meets the minimalist program. In Hector Campos & Paula Kempchinsky (eds.), *Evolution and revolution in linguistic theory*, 251–275. Georgetown: Georgetown University Press.
- Lasnik, Howard, Marcela Depiante & Arthur Stepanov. 2000. *Syntactic structures revisited: Contemporary lectures on classic transformational theory*. Cambridge, MA: MIT Press.
- Lees, Robert B. 1957. Review of syntactic structures. *Language* 33(3). 375–408.
- Levine, Robert D. 2012. Auxiliaries: to's company. *Journal of Linguistics* 48. 187–203.
- Levine, Robert D. 2013. The modal need vp gap (non)anomaly. In Eva Csipak, Regine Eckhardt, Mingya Liu & Manfred Sailer (eds.), *Beyond ever and any: New perspectives on negative polarity sensitivity*, Berlin: Mouton de Gruyter.

- Lewis, John D. & Jeffrey L. Elman. 2001. Learnability and the statistical structure of language: Poverty of stimulus arguments revisited. In *Proceedings of the 26th annual boston university conference on language development*, 359–370. Cascadilla Press.
- Linadarki, Evita. 2006. *Linguistic and statistical extensions of data oriented parsing*: University of Essex Phd dissertation.
- Marcus, Gary, Athena Vouloumanos & Ivan A. Sag. 2003. Does broca's play by the rules? *Nature Neuroscience* (7). 652–653.
- McCawley, James D. 1968. Concerning the base component of a transformational grammar. *Foundations of Language* 4(1). 55–81. Reprinted in *Meaning and Grammar*, 35–58. New York, NY: Academic Press (1976).
- Michaelis, Laura. 2011. Stative by construction. *Linguistics* 49. 1359–1400.
- Michaelis, Laura & Knud Lambrecht. 1996. Toward a construction-based model of language function: The case of nominal extraposition. *Language* 72. 215–247.
- Michaelis, Laura & Josef Ruppenhofer. 2001. *Beyond alternations: A constructional account of the applicative pattern in german*. Stanford: CSLI Publications.
- Mikkelsen, Line Hove. 2002. Specification is not inverted predication. In *Proceedings of nels, vol. 32, no. 2*, 403–422.
- Miller, Philip. 2013. Usage preferences: The case of the English verbal anaphor *do so*. In Stefan Müller (ed.), *Proceedings of the 20th international conference on head-driven phrase structure grammar, freie universität berlin*, 121–139.
- Miller, Philip & Geoffrey K. Pullum. 2013. Exophoric VP ellipsis. In Philip Hofmeister & Elisabeth Norcliffe (eds.), *The core and the periphery: data-driven perspectives on syntax inspired by ivan a. sag*, 167–220. CSLI Publications.
- Miller, Philip & Geoffrey K. Pullum. 2014. Exophoric vp ellipsis. In Philip Hofmeister & Elisabeth Norcliffe (eds.), *The core and the periphery: Data-driven perspectives on syntax inspired by ivan a. sag*, 5–32. Stanford, CA: CSLI Publications.
- Miyao, Yusuke & Junichi Tsujii. 2008. Feature forest models for probabilistic hpsg parsing. *Computational Linguistics* 34(1). 35–80.
- Müller, Stefan. 1995. Scrambling in German – Extraction into the *Mittelfeld*. In Benjamin K. T'sou & Tom Bong Yeung Lai (eds.), *Proceedings of the Tenth Pacific Asia Conference on Language, Information and Computation*, 79–83. City University of Hong Kong.
- Müller, Stefan. 1999. *Deutsche Syntax deklarativ: Head-Driven Phrase Structure Grammar für das Deutsche* (Linguistische Arbeiten 394). Tübingen: Max Niemeyer Verlag.
- Müller, Stefan. 2002. Blockaden und Deblockaden: Perfekt, Passiv und modale Infinitive. In David Reitter (ed.), *Proceedings of TaCoS 2002*, Potsdam.
- Müller, Stefan. 2004. An analysis of depictive secondary predicates in German without discontinuous constituents. In Stefan Müller (ed.), *Proceedings of the 11th International Conference on Head-Driven Phrase Structure Grammar, Center for Computational Linguistics, Katholieke Universiteit Leuven*, 202–222. Stanford: CSLI Publications.
- Müller, Stefan. 2006. Phrasal or lexical constructions? *Language* 82(4). 850–883.
- Müller, Stefan. 2007. Phrasal or lexical Constructions: Some comments on underspecification of constituent order, compositionality, and control. In Stefan Müller (ed.), *Proceedings of the 14th International Conference on Head-Driven Phrase Structure Grammar*, 373–393. Stanford: CSLI Publications.
- Müller, Stefan & Steven Wechsler. 2014. Lexical approaches to argument structure. *Theoretical Linguistics* (40). 176.
- Newmeyer, Frederick J. 1998. *Language form and language function*. Cambridge, MA: MIT Press.
- Nunberg, Geoff. 2001. *Shall We?* (on the legal profession's attachment to shall). California Lawyer, March.
- Palmer, Frank R. 1965. *A linguistic study of the english verb*. London: Longmans.
- Piatelli-Palmarini, Massimo. 1980. *Language and learning: The debate between jean piaget and noam chomsky*. Cambridge: Harvard University Press.
- Pollard, Carl J. & Ivan A. Sag. 1987. *Information-based syntax and semantics, vol. 1* (CSLI Lecture Notes 13). Stanford: CSLI Publications [Distributed by University of Chicago Press].
- Pollard, Carl J. & Ivan A. Sag. 1994. *Head-driven phrase structure grammar*. Chicago: University of Chicago Press.
- Potts, Christopher. 2003. *The logic of conventional implicatures*: UC Santa Cruz dissertation.
- Pullum, Geoffrey K. & Barbara C. Scholz. 2002. Empirical assessment of stimulus poverty arguments. *The Linguistic Review* 19. 9–50.

- Pullum, Geoffrey K. & Arnold M. Zwicky. 1997. Licensing of prosodic features by syntactic rules: The key to auxiliary reduction. Paper presented at Annual Meeting of the Linguistic Society of America. [Abstract available at <http://www-csli.stanford.edu/~zwicky/LSA97.abst.pdf>].
- Quirk, Randolph, Sidney Greenbaum, Geoffrey Leech & Jan Svartvik. 1985. *A comprehensive grammar of the english language*. London: Longman.
- Radford, Andrew. 2004. *Minimalist syntax - exploring the structure of english* Cambridge Textbooks in Linguistics. Cambridge: Cambridge University Press.
- Reali, Florencia & Morten H. Christiansen. 2005. Uncovering the richness of the stimulus: Structure dependence and indirect statistical evidence. *Cognitive Science* 29. 1007–1028.
- Reape, Mike. 1994. Domain union and word order variation in German. In John Nerbonne, Klaus Netter & Carl J. Pollard (eds.), *German in Head-Driven Phrase Structure Grammar* (CSLI Lecture Notes 46), 151–197. Stanford University: CSLI Publications.
- Ross, John R. 1967. *Constraints on variables in syntax*: MIT dissertation. [Published in 1986 as *Infinite Syntax!* Norwood, N. J.: Ablex].
- Ross, John Robert. 1969. Auxiliaries as main verbs. In W. Todd (ed.), *Studies in philosophical linguistics* Series 1, Evanston, IL: Great Expectations Press.
- Sag, Ivan A. 1997. English relative clause constructions. *Journal of Linguistics* 33(2). 431–484.
- Sag, Ivan A. 2010. English filler-gap constructions. *Language* 86. 486–545.
- Sag, Ivan A. 2012. Sign-based construction grammar: An informal synopsis. In Hans C. Boas & Ivan A. Sag (eds.), *Sign-based construction grammar*, 69–202. CSLI.
- Sag, Ivan A. & Joanna Nykiel. 2011. Remarks on sluicing. In Stefan Müller (ed.), *Proceedings of the hpsg-2011 conference, university of washington*, 188–208. Stanford: CSLI Publications.
- Sag, Ivan A. & Thomas Wasow. 2015. Flexible processing and the design of grammar. *Journal of Psycholinguistic Research* 44. 47–63.
- Sag, Ivan A., Thomas Wasow & Emily M. Bender. 2003. *Syntactic theory: A formal introduction*. Stanford: CSLI Publications 2nd edn.
- Scholz, Barbara C. & Geoffrey K. Pullum. 2006. Irrational nativist exuberance. In Robert Stainton (ed.), *Contemporary debates in cognitive science*, 59–80. Oxford: Basil Blackwell.
- Schütze, Carson T. 2004. Synchronic and diachronic microvariation in english *do*. *Lingua* 114. 495–516.
- Shieber, Stuart M. 1986. *Introduction to unification-based approaches to grammar*. Stanford, CA: volume 4 of CSLI Lecture Notes Series. Center for the Study of Language and Information.
- Slobin, Dan I. 1966. Grammatical transformations and sentence comprehension in childhood and adulthood. *Journal of verbal learning and verbal behavior* 5. 219–227.
- Staab, Jenny. 2007. *Negation in context: Electrophysiological and behavioral investigations of negation effects in discourse processing*: UCSD/SDSU Doctoral dissertation.
- Starosta, Stanley. 1985. The great AUX cataclysm. In *University of hawaii working papers in linguistics*, vol. 17 2, 95–114.
- Steedman, Mark. 1996. *Surface structure and interpretation* Linguistic Inquiry Monograph No. 30. Cambridge, MA: MIT Press.
- Steedman, Mark. 2000. *The syntactic process* Linguistic Inquiry Monograph No. 30. Cambridge, MA: MIT Press/Bradford Books.
- Stump, Gregory T. 1985. *The semantic variability of absolute constructions* Synthese Language Library. Dordrecht: Reidel.
- Tanenhaus, Michael, K. Eberhard M. Spivey-Knowlton & J. Sedivy. 1995. Integration of visual and linguistic information during spoken language comprehension. *Science* (268). 1632–1634.
- Walter, Mary Ann & T. Florian Jaeger. 2005. Constraints on complementizer/relativizer drop: A strong lexical ocp effect of that. In *Proceedings of the 41st annual meeting of the chicago linguistics society*, CLS Chicago, Illinois: CLS.
- Warner, Anthony. 2000. English auxiliaries without lexical rules. In Robert Borsley (ed.), *The nature and function of syntactic categories*, vol. 32 Syntax and Semantics, 167–220. San Diego and London: Academic Press.
- Warner, Anthony R. 1993. The grammar of English auxiliaries: An account in HPSG. Research Paper YLLS/RP 1993-4 Department of Language and Linguistic Science University of York.
- Wason, Peter Cathcart. 1961. Response to affirmative and negative binary statements. *British Journal of Psychology* 63(2). 133–142.
- Zwicky, Arnold M. 1986. The unaccented pronoun constraint in English. In Arnold M. Zwicky (ed.), *Interfaces, volume 32 of ohio state university working papers in linguistics*, 100–114. Ohio State University Department of Linguistics.

- Zwicky, Arnold M. 1994. Dealing out meaning. In *Proceedings of the twentieth annual meeting of the berkeley linguistics society*, 611–625. Berkeley: BLS.
- Zwicky, Arnold M. & Geoffrey K. Pullum. 1983. Cliticization versus inflection: English n't. *Language* 59. 502–513.