

The challenges and promises of (semantic) typology

Jürgen Bohnemeyer, UB



Image credit: Infinite dictionary

Workshop in honor of

Matthew Dryer and Robert D. Van Valin, Jr.

January 10, 2020

ROADMAP

- ▶ The shoulders of giants
- ▶ The case for categorical particularism
- ▶ Some challenges of categorical particularism
- ▶ An ontology for categorical particularism
- ▶ Description, typology, and linguistic theory
- ▶ The future of typology (and linguistics)
- ▶ Epilog

THE SHOULDERS OF GIANTS

- ▶ thoughts on linguistic typology
 - ▶ inspired by themes from Dryer's and Van Valin's work
- ▶ Theme I: categorical particularism (Dryer 1997; Haspelmath 2007, 2010; *inter alia*)
 - ▶ if the phenomena that typologists endeavor to compare and generalize over are strictly language-specific
 - ▶ then how, or *in what sense*, can we compare them and generalize over them?



- ▶ Theme II: the relations among description, typology, and linguistic theory
 - ▶ what assumptions can typologically valid descriptions of language-specific phenomena presuppose, given that
 - ▶ there is very little uncontested common ground among contemporary linguistic theories
 - ▶ existing theories/frameworks are by necessity biased towards the better-studied languages?

- ▶ Theme III: the future of typology
 - ▶ why is linguistics apparently unique in the world of contemporary academia in having a typological branch?
 - ▶ is this a transitional artifact of the immaturity of linguistics (Heath 2016)
 - ▶ or is there something about language (and linguistics) that makes typology a productive approach
 - ▶ in a way that is likely here to stay (for a while)?

ROADMAP

- ▶ The shoulders of giants
- ▶ The case for categorical particularism
- ▶ Some challenges of categorical particularism
- ▶ An ontology for categorical particularism
- ▶ Description, typology, and linguistic theory
- ▶ The future of typology (and linguistics)
- ▶ Epilog

THE CASE FOR CATEGORICAL PARTICULARISM

“It was one of the major insights of structuralist linguistics of the twentieth century (especially the first half) that **languages are best described in their own terms** (e.g. Boas 1911), rather than in terms of a set of preestablished categories that are assumed to be universal, although in fact they are merely taken from an influential grammatical tradition (e.g. Latin grammar, or English grammar, or generative grammar, or ‘basic linguistic theory’). This alternative, nonaprioristic approach to categories can be called CATEGORIAL PARTICULARISM. In this approach, language-particular analyses can be carried out independently of comparative linguistics.” (Haspelmath 2010: 664; emphasis *JB*)

- ▶ I disagree with the underlined part and with one interpretation of the bolded part
 - ▶ so let me propose an alternative characterization

▶ but first - a terminological hack

Descriptive categories of language L : the linguistic units a description of L is about - the lexical items, constructions, sound patterns, and usage practices of L .

- ▶ sneak preview: the present proposal
 - ▶ decompose descriptive categories in terms of sets of properties
 - ▶ i.e., morphosyntactic, semantic/pragmatic, morphophonological/phonetic properties
 - ▶ compare them across languages on this basis

▶ restating categorical particularism

Categorical particularism (CP) - methodological maxim (CPM): Describe the basic semiotic elements of natural languages - morphemes and constructions, along with their phonetic/phonological forms, their meanings, and their associated practices of use - in language-specific terms rather than as instances of universal categories.

Categorical particularism (CP) - epistemological maxim (CPE): no data from one language can ever be validly used to support an analysis/description of any semiotic element (phoneme, morpheme, or construction) of another language.

- ▶ suppose an analysis/description of a given descriptive category is an explication (= explicit statement)
 - ▶ of its phonetic/morphonological, morphosyntactic, and semantic/pragmatic properties
- ▶ then CPE simply states
 - ▶ that the properties of any descriptive category of Language A can only be inferred from A data
- ▶ the implications of CPM and CPE are examined below

▶ the alternative to CP: categorical universalism (CU)

Categorical universalism (CU): The view that the descriptive categories of natural languages instantiate crosslinguistic categories and that their properties can be inferred from the categories they instantiate once these have been discovered.

- ▶ CP and CU differ in what they see as the goals of both description and typology
 - ▶ CU: describing a given semiotic element is to identify its proper crosslinguistic category
 - ▶ typological studies target the distribution of crosslinguistic categories
 - ▶ CP: describing a given semiotic element is to identify its (language-specific) properties to the fullest extent
 - ▶ my view, to be argued for below:
typological studies target the distribution of *properties*

- ▶ making the case for CPM
 - ▶ argumentation similar to that in Dryer (1997, 2016), Haspelmath (2007, 2010), Cristofaro (2009), *inter alia*
 - ▶ cite examples of constructions that do not fit any easily recognizable crosslinguistic pattern
 - ▶ argue that calling less exotic constructions ‘prototypical’ confuses prototypicality with familiarity
 - ▶ for the first part of this argument
 - ▶ let me take you on a whirlwind tour of Mayan grammar

- ▶ Example I: 'status' inflection
 - ▶ an inflectional category of the Mayan verb
 - ▶ combines in a single suffix position viewpoint aspect, mood, and illocution
 - ▶ allomorphy sensitive to verb class including transitivity

Table 1.1. *Status subcategories*

Subcategory	Distribution	Aspectual meaning	Mood/illocution meaning
Complete	Independent verbal cores w/ preverbal perfective marker	Perfective	<u>Realis</u>
<u>Incomplete</u>	Dependent verbal cores; independent verbal cores w/ preverbal imperfective marker	Imperfective	Unmarked
Subjunctive	Dependent verbal cores; insubordinate jussive clauses; counterfactual conditionals; <u>irrealis</u> subordinate clauses	Perfect, prospective	<u>Irrealis</u>
Extra-focal	<u>Manner focus construction (dependent verbal core)</u>	Perfective	<u>Backgrounded</u>
Imperative	Imperative sentences	Perfective	Imperative

Table 1.2. *Status allomorphy*

	Status <u>Incomplete</u>	Complete	Subjunctive	Extra-focal	Imperative
Stem class					
Active	-∅	<u>-nah</u>	<u>-nak</u>	<u>-nahik</u>	<u>-nen</u>
Inactive	<u>-Vl</u>	-∅	<u>-Vk</u>	<u>-ik</u>	<u>-en</u>
Inchoative	<u>-tal</u>	<u>-chah</u>	<u>-chahak</u>	<u>-chahik</u>	N/A
Dispositional	<u>-tal</u>	<u>-lah</u>	<u>-l(ah)ak</u>	<u>-lahik</u>	<u>-len</u>
Transitive	<u>-ik</u>	<u>-ah</u>	-∅ / -eh	<u>-ahil</u>	-∅ / -eh
Active					
Passive	<u>∕ ...-Vl</u> <u>∕ -a'l</u>	<u>∕ ...-ab</u> <u>∕ -a'b</u>	<u>∕ ...-Vk</u> <u>∕ -a'k</u>	<u>∕ ...-ik</u> <u>∕ -a'bik</u>	N/A

- ▶ Example II: preverbal 'aspect-mood markers'
 - ▶ approximately 15 mutually exclusive preverbal markers expressing viewpoint aspect, modality, and remoteness
 - ▶ auxiliary-like in that they analytically express verbal inflectional categories
 - ▶ *not* auxiliary-like in that they are stative predicates and do not themselves inflect like verbs

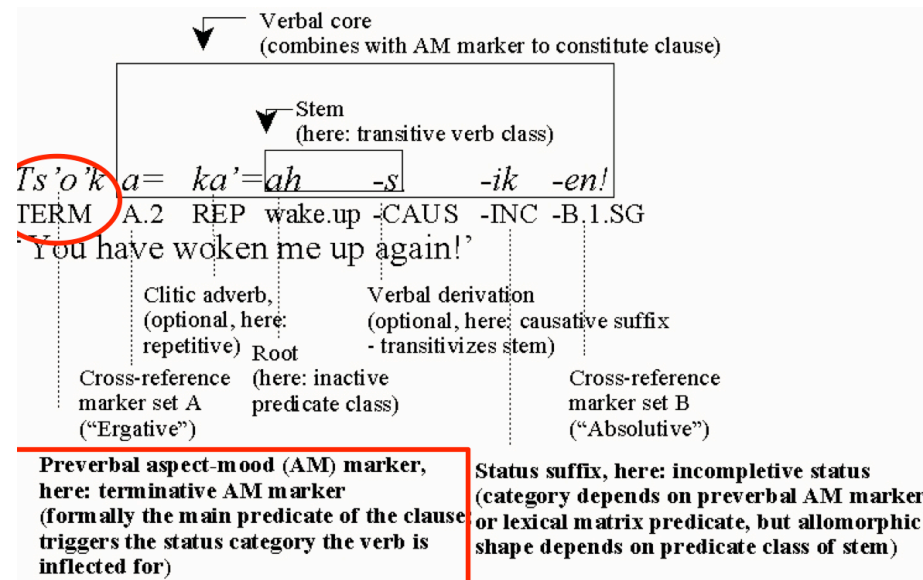

Figure 1.1. Yucatec clause and preverbal aspect-mood markers

- ▶ Example III: finiteness
 - ▶ Yucatec is a tenseless language
 - ▶ person marking is retained on all verb forms except for lexical nominalizations
 - ▶ there is a finiteness contrast, which distinguishes clauses (finite) from cores (non-finite)
 - ▶ but this contrast is expressed in terms of the presence (finite) vs. absence (non-finite) of the preverbal marker

In matrix clauses, aspect is marked in two positions: by a verbal **prefix** or auxiliary, and by a verbal **suffix**.

(1.1) T-inw=il-ah
 PRV-A1SG=see-CMP(B3SG)
 'I saw you fall(ing)'

In non-finite cores, only the **suffix** appears

a=lúub-ul
 A2=fall-INC

- ▶ Example IV: lexical categories
 - ▶ omnipredicative language (Launey 1994)
 - ▶ all content words have the morphosyntactic wherewithal to head syntactic predicates w/o a copula
 - ▶ however, only verbs inflect for status (and there are virtually no stative verbs in Yucatec)

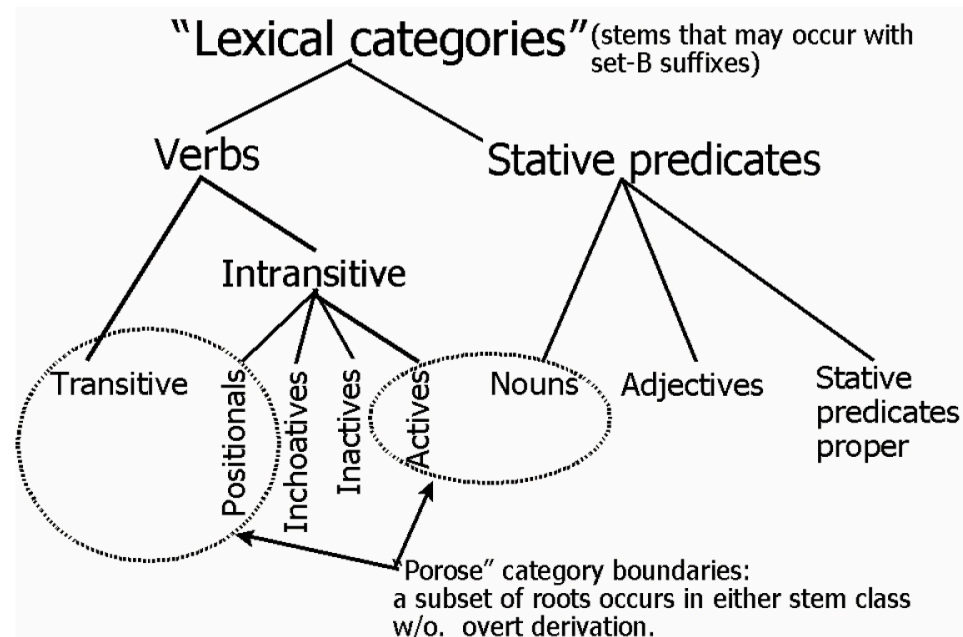

Figure 1.2. Yucatec stem classes classified by language-specific criteria

- ▶ Example V: dispositionals (Bohnemeyer & Brown 2007)
 - ▶ a lexical category unique to Mayan languages
 - ▶ may surface as unaccusative verbs, stative predicates, and numeral classifiers
 - ▶ but in principal require derivational morphology in all of these manifestations - so not inherently verbs
 - ▶ although a large subclass of bases produce transitive stems without derivation
 - ▶ lexicalize non-locative, stage-level spatial concepts including postures
 - ▶ set size ranges from ~160 in Yucatec to 600-700 in Q'anjob'al (Mateo Toledo 2004)

- ▶ Example VI: no evidence of construction-general grammatical relations (Bohnemeyer 2009)
 - ▶ cf. also Van Valin 1981 on Jakaltek
 - ▶ split-intransitive alignment morphology governed by status inflection (Bohnemeyer 2004)
 - ▶ S patterns w/ A in incompletive status, otherwise w/ O
 - ▶ linking in transitive clauses governed by topicality/obviation constraints
 - ▶ extraction and control follow construction-specific rules

- ▶ bottom line: Mayan languages have lots of features that appear "exotic" = unique to Mayan in first approximation
- ▶ so is Mayan exceptionally exotic? I don't think so!

Fiction:
categorical universalism

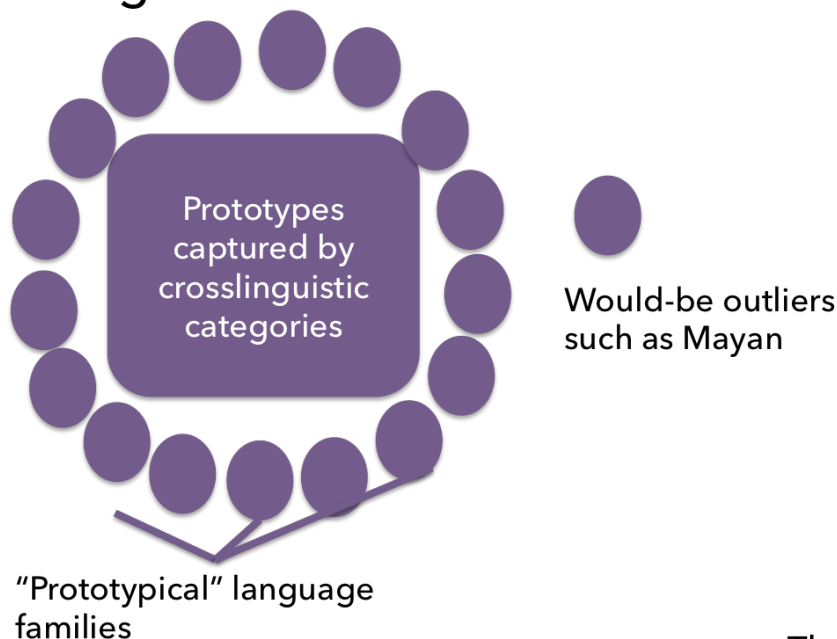

Figure 1.3. Prototypes and crosslinguistic categories: fact vs. fiction

Fact:
categorical particularism

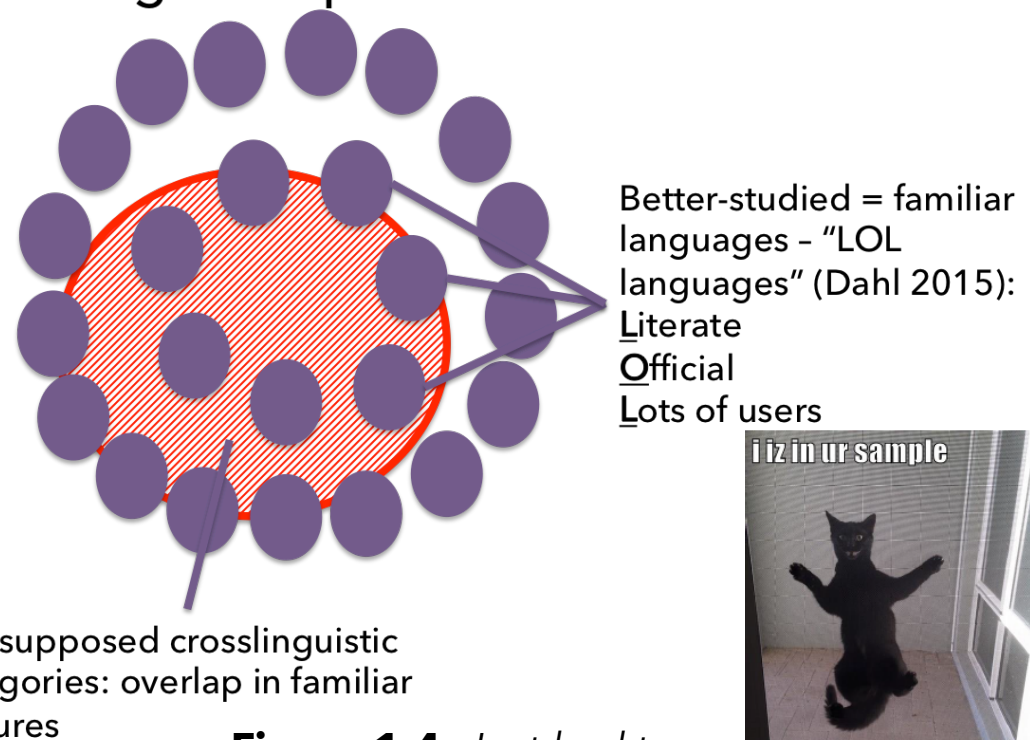
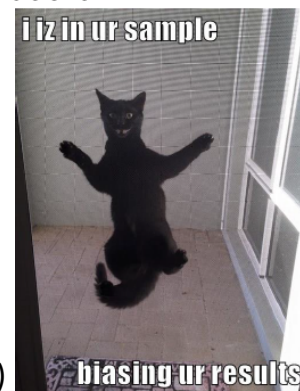

Figure 1.4. Just had to steal this from Dahl (2015)



- ▶ up to this point, this is an empirical issue
 - ▶ empirically, the languages of the world just don't appear sufficiently uniform to support CU
- ▶ as a matter of course, theoretical commitments play a role
 - ▶ those who base their work on assumptions about UG are saddled with CU perforce
 - ▶ a radical constructionist view all but entails CP as a methodological principle (Croft 2001)

- ▶ are crosslinguistic prototypes discoverable as *results*, not tools, of typological research, per Dahl (1985, 2016)?
 - ▶ e.g., can we identify
 - ▶ prototypical past tenses as particularly common clusters of types of past time reference
 - ▶ prototypical relative clauses as particularly common clusters of types of desentential adnominal modifiers
 - ▶ etc.?
 - ▶ the problem
 - ▶ prototypes should be postulated on the basis of psychological evidence

ROADMAP

- ▶ The shoulders of giants
- ▶ The case for categorical particularism
- ▶ Some challenges of categorical particularism
- ▶ An ontology for categorical particularism
- ▶ Description, typology, and linguistic theory
- ▶ The future of typology (and linguistics)
- ▶ Epilog

SOME CHALLENGES OF CATEGORICAL PARTICULARISM

- ▶ two challenges arising from Haspelmath's (2010) program
 - ▶ first, if we decouple language description from typology/comparative linguistics
 - ▶ then how do we ensure that language descriptions remain interpretable for crosslinguistic research
 - ▶ and retain the benefits of being typologically informed (cf. also Himmelmann 2016, 2019)?
 - ▶ in other words: how can language description be maximally typologically informed
 - ▶ w/o violating CPM and CPE?

- ▶ secondly, Haspelmath argues that comparative linguistics should be based on **comparative concepts**
 - ▶ instead of crosslinguistic categories

“Thus, I claim that what crosslinguistic grammatical research is based on in general is comparative concepts. Comparative concepts are concepts created by comparative linguists for the specific purpose of crosslinguistic comparison. Unlike descriptive categories, they are not part of particular language systems and are not needed by descriptive linguists or by speakers. They are not psychologically real, and they cannot be right or wrong. They can only be more or less well suited to the task of permitting crosslinguistic comparison. (...) Comparative concepts are needed for stating empirically testable universal claims.” (Haspelmath 2010: 665)

- ▶ but what exactly is the nature of comparative concepts
 - ▶ such that we can ensure
 - ▶ that generalizations based on them are meaningful, informative, and valid generalizations
 - ▶ over the world's extant natural languages?
- ▶ and how exactly do they relate to the language-specific categories invoked by descriptions?

- ▶ the (modest) proposal in a nutshell
 - ▶ both descriptive categories and comparative concepts can be defined as **sets of properties**
 - ▶ i.e., sets of phonetic, morphophonological, morphosyntactic, and semantic/pragmatic properties
 - ▶ whereas the particular set of properties that jointly constitute a descriptive category is language-specific
 - ▶ the properties out of which such categories are composed are universal (in a formal ontological sense)
 - ▶ comparative concepts are property sets “configured” (i.e., defined) for the purposes of typological research

- ▶ how the proposal addresses the challenges
 - ▶ description and comparison/typology remain mutually relevant
 - ▶ because their operational concepts are composed from the same building blocks
 - ▶ typological studies based on comparative concepts yield meaningful and valid generalizations
 - ▶ because comparative concepts are composed out of the same properties used to describe languages

► these are not exactly new ideas

*"Precision. AUTOTYP databases strive for as detailed as possible a break-down of descriptive notions into unambiguous terms. Notions like 'relative clause' figure only as practical labels; the actual information behind such notions is distributed over several fields (e.g. values in fields such as *clause linkage type*, *part of speech*, *finiteness*, and *argument representation*). "* (<http://www.autotyp.uzh.ch/theory.html> last accessed 01/09/2020)



Figure 3.1. *Thanks, Captain Obvious!* (Image credit: Imgflip)

"The paper argues that essential ingredients to proper description are fine-grained variables that can be applied across languages (...) (see also Bickel 2007). Inasmuch as language-specific categories are defined by such variables, they are commensurable. If this is accepted, there is no principled distinction between descriptive and comparative concepts (...)" (Himmelman 2019)

- ▶ these are not exactly new ideas (cont.)
 - ▶ Lehmann's (2004 etc.) view of descriptive categories as language-specific mappings
 - ▶ between universal 'onomasiological' and 'semasiological' categories
 - ▶ may be salvageable under a property-based reconstruction as well

ROADMAP

- ▶ The shoulders of giants
- ▶ The case for categorical particularism
- ▶ Some challenges of categorical particularism
- ▶ An ontology for categorical particularism
- ▶ Description, typology, and linguistic theory
- ▶ The future of typology (and linguistics)
- ▶ Epilog

AN ONTOLOGY FOR CATEGORICAL PARTICULARISM

- ▶ just some thoughts on formal ontology revolving around the themes introduced above
- ▶ a super-simple (likely overly reductive) toy ontology comprising nothing but
 - ▶ languages
 - ▶ semiotic elements (lexical items, constructions, sounds, ...)
 - ▶ linguistic properties
- ▶ the basic idea
 - ▶ semiotic elements are properties of languages
 - ▶ linguistic properties are either semiotic elements or properties of semiotic elements

- ▶ but first: what do I mean by 'property'?
- ▶ ontologically speaking, properties are **universals**
 - ▶ as opposed to **particulars**, i.e., concepts that describe stuff individuated by time and space
 - ▶ which could in principle carry a proper name

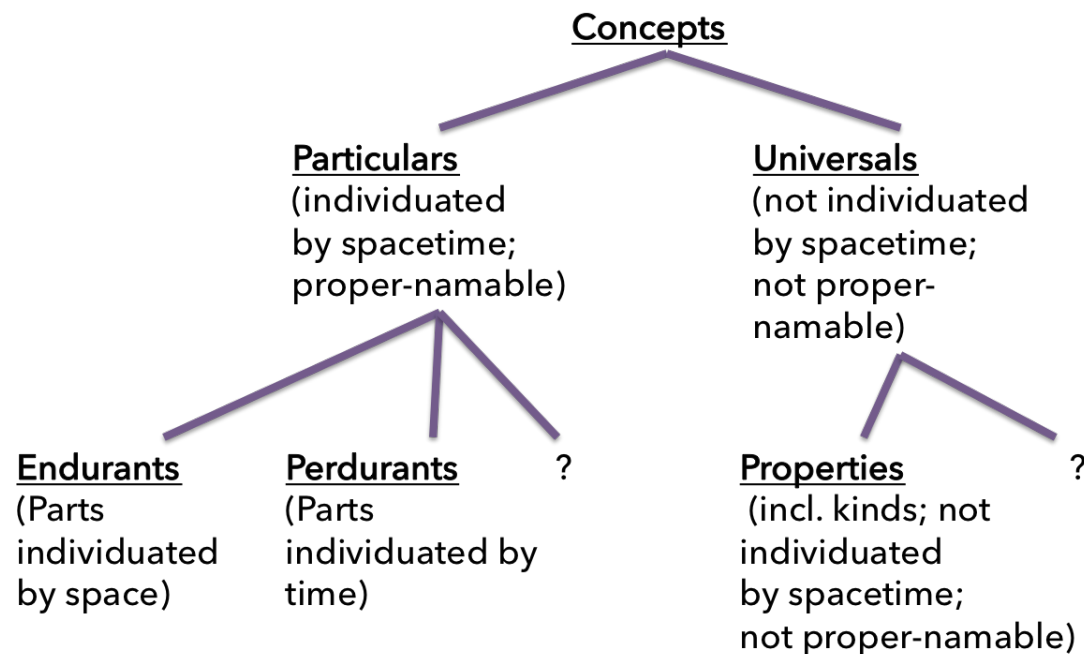

Figure 4.1. *Generic upper-level ontology*

- ▶ closer look: languages
 - ▶ particulars at first blush, but of a weird kind
 - ▶ languages are an example of a large fairly heterogeneous class of **pseudo-endurants**
 - ▶ i.e., concepts lexicalized by count nouns even though they don't really have a spatial mereology
 - ▶ including
 - ▶ **Institutions**: family; party; church; state; **Collectives**: rice; gravel; sand; **Substances**: water; chocolate; cement; gold; wood; air; oxygen; **Gestalt objects**: hole; aperture; wave; eddy; vortex; lightning bolt; **Forces**: gravity; libido; stress; pressure; **Times, seasons**: evening; spring; era; **Landforms**: hill; estuary; grove; **Surfaces, regions**: front; back; side; **Conditions**: cold; draught; famine; sickness

- ▶ closer look: languages (cont.)
 - ▶ languages are sets of semiotic practices shared through social networks
 - ▶ however, no two speakers share the exact same set of semiotic practices
 - ▶ isoglosses cluster to some extent, but do not align
 - ▶ dialect continua and contact-induced change further blur the spatial boundaries of languages
 - ▶ this becomes important when comparing linguistic typology
 - ▶ to how neighboring disciplines deal with comparison
 - ▶ cf. below

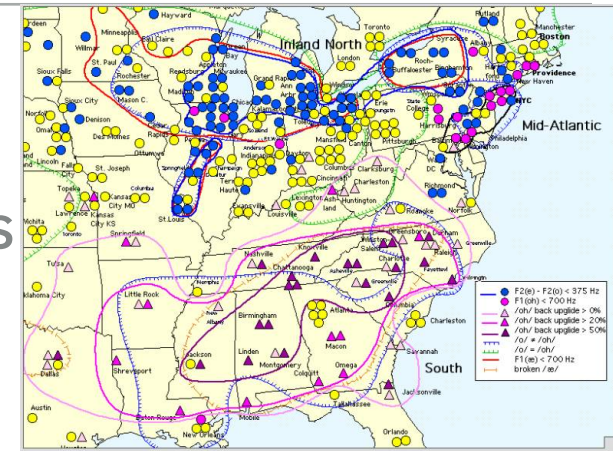
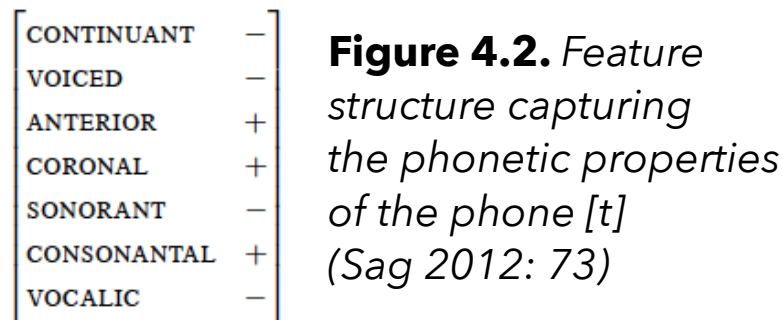

Figure 4.2. Some phonological isoglosses of contemporary AE
www.ling.upenn.edu/.../image00

- ▶ closer look: semiotic elements
 - ▶ semiotic elements are
 - ▶ properties of particular languages
 - ▶ globally described by descriptive categories
 - ▶ narrowly described by the linguistic properties that constitute the descriptive categories
 - ▶ like languages, semiotic elements are particulars
 - ▶ although they too have a “weird” aspect: the type-token dichotomy (Dahl 2016)

- ▶ closer look: semiotic elements (cont.)
 - ▶ the view that semiotic elements can be represented as sets of properties (predicates, features)
 - ▶ is quite common and familiar throughout linguistics



verb-way-ext ⇒

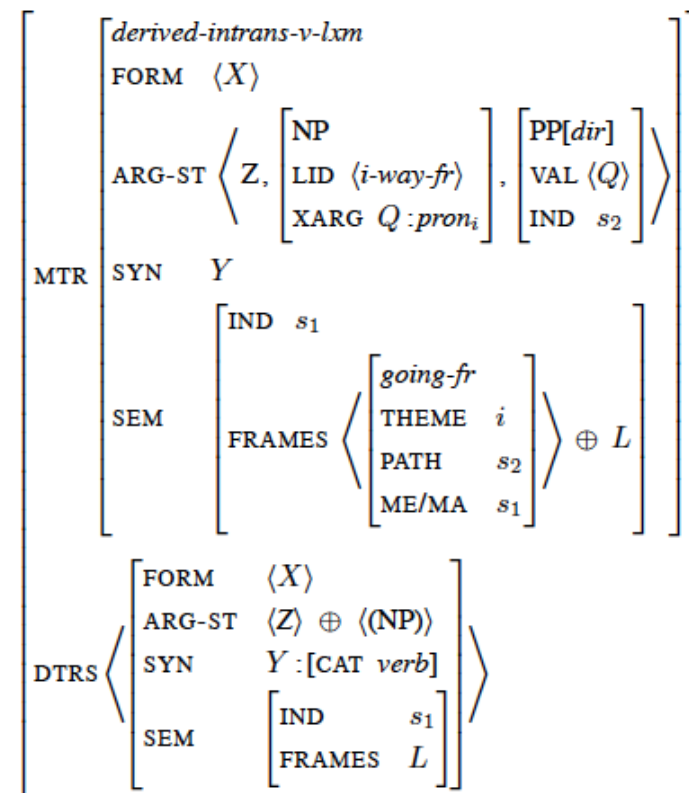

Figure 4.3. Morphosyntactic and semantic properties of the way construction captured by a feature structure in Sign-Based Construction Grammar (Sag 2012: 142)

- ▶ descriptive categories and comparative concepts as property bundles
 - ▶ example: we can identify V(O)S and SV(O) orders in Yucatec
 - ▶ without presupposing that Yucatec clauses descriptively have subjects
 - ▶ by defining 'S' for the purposes of the investigation as a comparative concept
 - ▶ comprising two properties
 - ▶ the single argument of intransitive verbs
 - ▶ the actor argument of transitive verbs

- ▶ etic grids
 - ▶ the etic-emic distinction (Pike 1967) aligns closely
 - ▶ with that between descriptive categories (emic) and comparative concepts (etic)
 - ▶ etic grids decompose comparative concepts into the independent variables (properties) that constitute them
 - ▶ a great deal of the controversy surrounding their use (Lucy 1997; Saunders & van Brakel 1997)
 - ▶ boils down to the potential of misinterpreting grid-based comparative categories
 - ▶ as descriptive emic categories

ROADMAP

- ▶ The shoulders of giants
- ▶ The case for categorical particularism
- ▶ Some challenges of categorical particularism
- ▶ An ontology for categorical particularism
- ▶ Description, typology, and linguistic theory
- ▶ The future of typology (and linguistics)
- ▶ Epilog

DESCRIPTION, TYPOLOGY, AND LINGUISTIC THEORY

▶ recap: CPE

Categorical particularism (CP) - epistemological maxim (CPE): no data from one language can ever be validly used to support an analysis/description of any semiotic element (phoneme, morpheme, or construction) of another language.

▶ so where does this leave linguistic theory

- ▶ given that theories of language are necessarily based on evidence/data from particular languages

- ▶ even if they make a dedicated effort at typological breadth and avoiding bias

- ▶ as is the case with Role & Reference Grammar (RRG; Foley & Van Valin 1985; Van Valin 2005)

- ▶ and Basic Linguistic Theory (Dixon 2010)

- ▶ my sense: the entire discipline of linguistics is currently undergoing the most profound change since the 1960s
 - ▶ an inversion of core and periphery

Simplified late-20th-Century view
of the systems architecture of linguistics

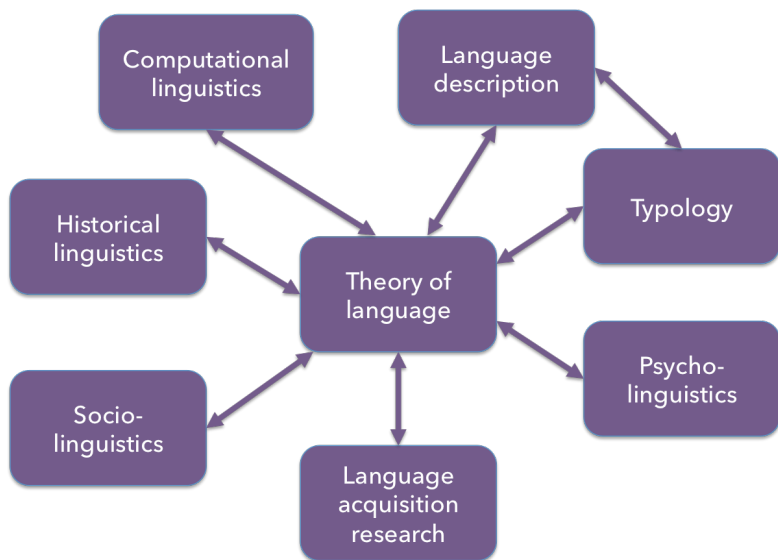

Emerging 21st-Century view
of the systems architecture of linguistics

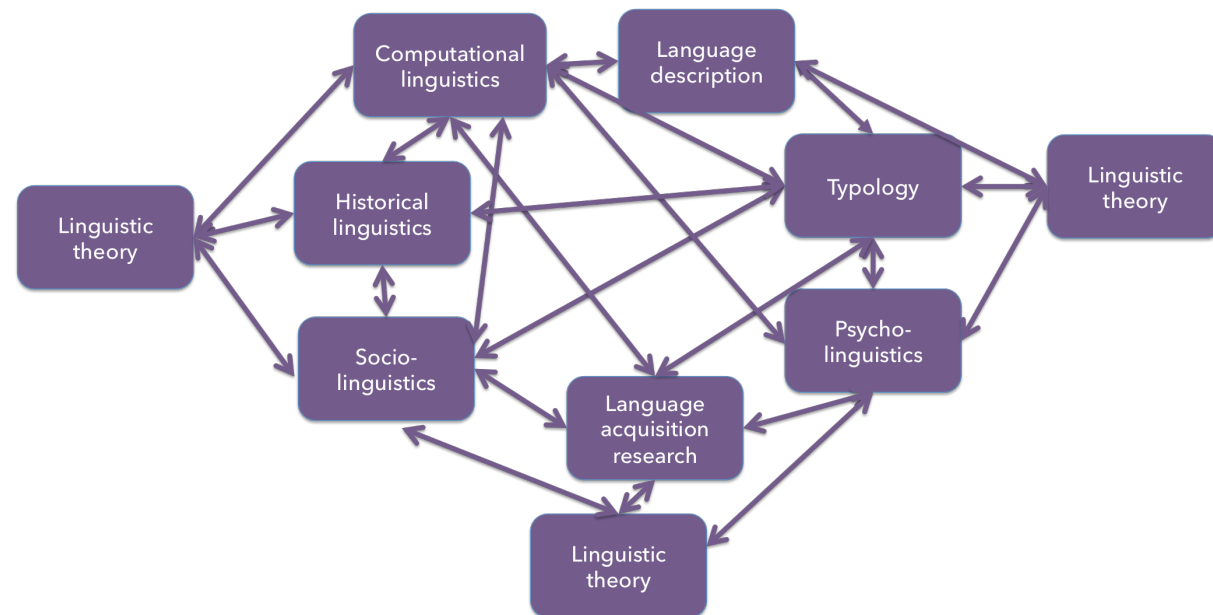

Figure 5.1. *The changing landscape of linguistics*

- ▶ the proper role of linguistic theories/frameworks in description and typology
 - ▶ propose potentially useful property concepts
 - ▶ propose potentially useful comparative concepts
 - ▶ generate hypotheses
 - ▶ e.g., core junctures that have the 'macro-event property' exhibit cosubordinate nexus
 - ▶ cf. Bohnemeyer & Van Valin (2017)

Chris went (*yesterday) to see Pat today.

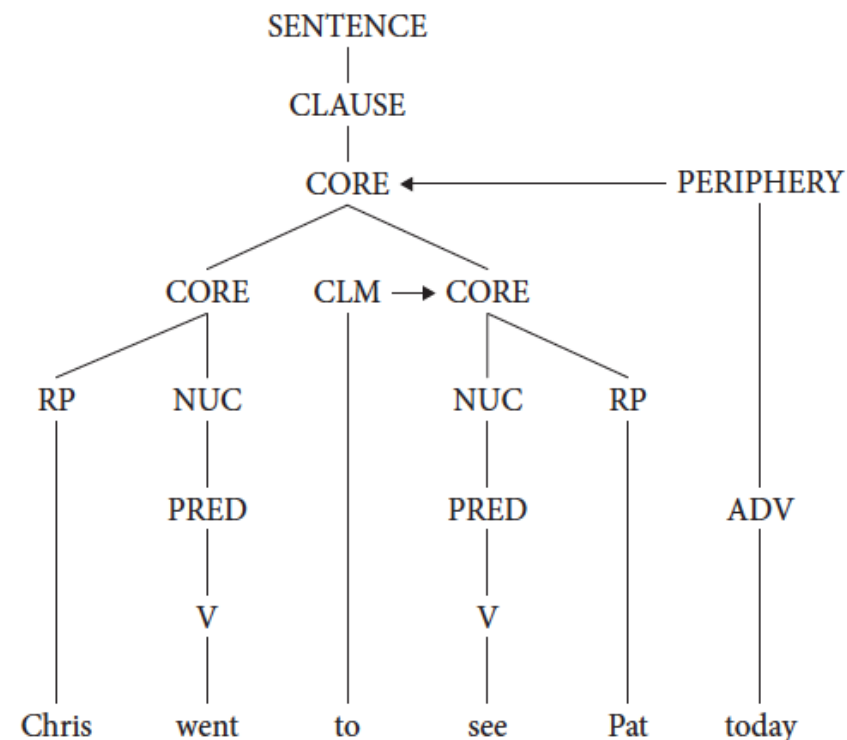

Figure 5.2. Core cosubordination, periphery sharing, and the macro-event property (Bohnemeyer & Van Valin 2017: 167)

- ▶ the proper role of linguistic theories/frameworks in description and typology (cont.)
 - ▶ whether such hypotheses make valid crosslinguistic generalizations is an empirical question
 - ▶ to be tested by typologists
 - ▶ it is not obvious that linguistic theories have a genuine *explanatory* role
 - ▶ beyond suggesting hypothetical relationships among linguistic properties

ROADMAP

- ▶ The shoulders of giants
- ▶ The case for categorical particularism
- ▶ Some challenges of categorical particularism
- ▶ An ontology for categorical particularism
- ▶ Description, typology, and linguistic theory
- ▶ The future of typology (and linguistics)
- ▶ Epilog

THE FUTURE OF TYPOLOGY (AND LINGUISTICS)

- ▶ Heath (2016) makes an interesting observation
 - ▶ biology and cultural anthropology share with linguistics a concern with variation created by evolution
 - ▶ yet typology no longer plays a significant role in either discipline
 - ▶ although both can be argued to have gone through typological stages

Table 6.1. *Analogies b/w contemporary linguistics and mid-20th-century cultural anthropology (Heath 2016: 483)*

Linguistics	Sociocultural anthropology
functionalists	functional-structuralists
Greenberg	Morgan
grammaticalization theory	evolutionary sequencing
ergativity	matriliney
Chomsky	Lévi-Strauss
generative grammar	structuralist anthropology
microtypology	controlled comparison (microethnology)
WALS (Dryer & Haspelmath (eds.) 2013)	HRAF
(emerging)	historicization of anthropology

- ▶ Heath's diagnosis: the existence of linguistic typology is a symptom of the immaturity of linguistics

"Classificatory typology always has its heyday at an early stage of development of empirical disciplines in the biological and human sciences. An initial wave of intrepid explorers document "what's out there" and their primary data has to be organized and classified. Eventually, the discipline moves on to the study of how organic subsystems interact in their environments, and how entire systems evolve over time." (Heath 2016: 491)

- ▶ let's consider the possibility that Heath is wrong
 - ▶ then presumably the reason he's wrong would have to have something to do
 - ▶ with how languages differ from both biological species and cultures

- ▶ cultural anthropology has largely abandoned systematic large-scale comparative work
 - ▶ because cultures resemble true endurants vastly less than languages do
 - ▶ we can come up with ballpark estimates of how many languages there are left on the planet
 - ▶ nobody seriously attempts to count cultures today

- ▶ biology has moved beyond Linnaean taxonomy because the Neo-Darwinian synthesis has made this possible
 - ▶ in linguistics, while we can propose evolutionary explanations for observed typological distributions
 - ▶ there is to date no equivalent to molecular biology for testing such hypotheses

- ▶ languages assume an intermediate ontological position
 - ▶ between true endurants such as living organisms
 - ▶ and extremely non-spatial pseudo-endurants such as cultures
- ▶ this intermediate status may ensure that typology is here to stay for the foreseeable future

- ▶ the possibility space for typology is actually exploding as we speak
 - ▶ thanks to the rapidly expanding application of advanced data analysis
- ▶ Heath may be right in at least two respects
 - ▶ dovetailing with evolutionary theory is emerging as a major theme in typology
 - ▶ typologists may increasingly shed their Greenbergian ways of being secondary data hunter-gatherers
 - ▶ in favor of becoming primary data “agriculturalists”



Figure 6.1. *The best is yet to come (image credit: [amazon.com](https://www.amazon.com))*



Convolut ed metaphor alert!



- ▶ sneak preview: ongoing work of the UB Semantic Typology Lab
- ▶ Causality Across Languages (CAL)
 - ▶ combined production and rating data collected with 43 video clips from 12+ speakers per language

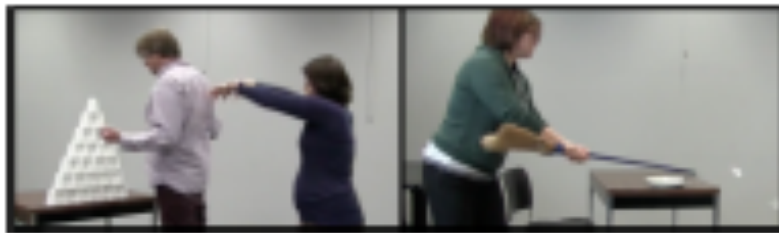

Figure 6.2. Video stimuli: The CAL Clips

- ▶ manipulated variables:
 - ▶ causer typer; causee/affectee type; mediation (directness *sensu stricto*)

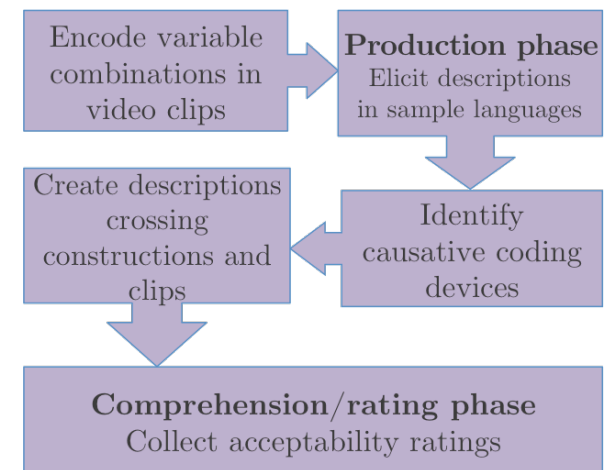
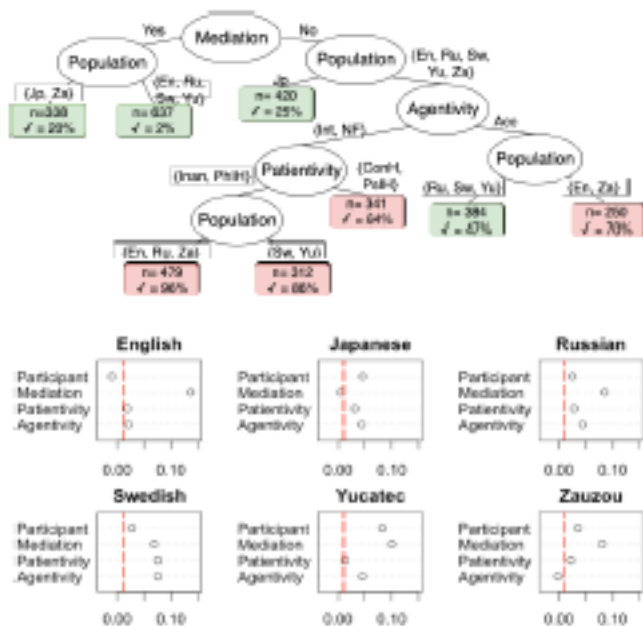

Figure 6.3. A hybrid production/comprehension design

► Causality Across Languages (CAL) (cont.)

- findings: the use of lexical and morphological causatives is primarily governed by mediation (“directness”)
 - but the use of periphrastic causatives is dominated by agentivity and patientivity

Results [1] *Lexical/morph. causatives*



Results [2] *Periphrastic causatives*

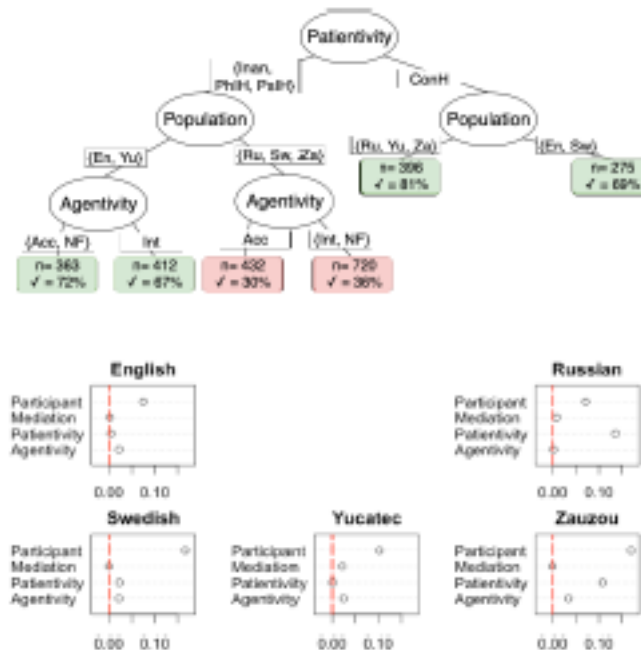

Figure 6.4. Conditional inference trees and random forest plots on acceptability ratings from speakers of six languages

- ▶ Causality Across Languages (CAL) (cont.)
 - ▶ these findings can be explained by a combination of the Iconicity Principle (Haiman 1983)
 - ▶ with the Transitivity Hypothesis (Hopper & Thompson 1980)
 - ▶ since agentivity and patientivity are primarily determined at the core/clause level, not lexically

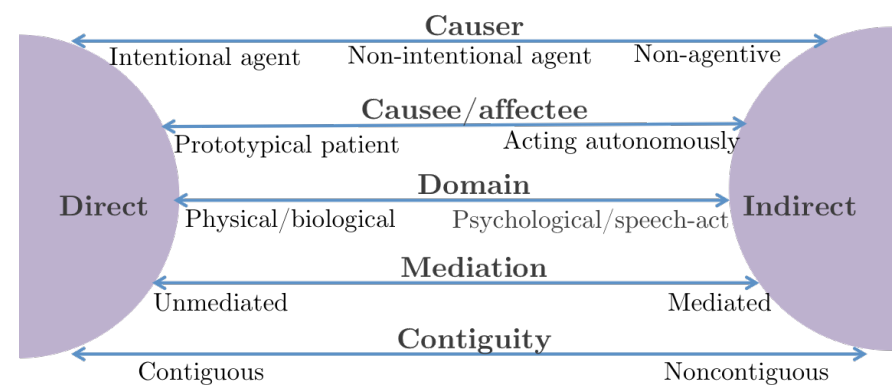
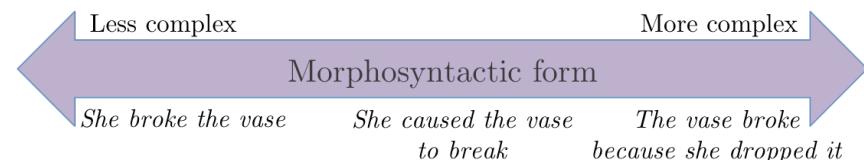

Figure 6.5. A multi-dimensional model of directness of causation



- ▶ Causality Across Languages (CAL) (cont.)
 - ▶ additional finding: variation in acceptability is not uniform across syntactic levels
 - ▶ it peaks at the level of periphrastic causatives
 - ▶ both lexical/morphological causatives and causal connective constructions behave more uniformly

- ▶ MesoSpace: spatial reference frame use in discourse and recall memory
 - ▶ using referential communication matching games (discourse) and array reconstruction tasks (memory)
 - ▶ comparing the impact of linguistic, environmental, and demographic variables

Figure 6.6. *Really weird map (with study populations)*



► MesoSpace (cont.)

- findings: environmental variables dominate in nonverbal cognition, demographic variables in discourse
- while language is an irreducible factor in both

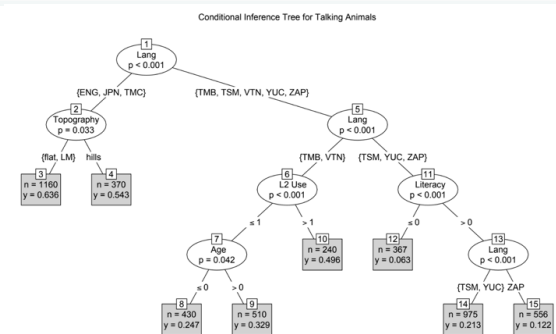
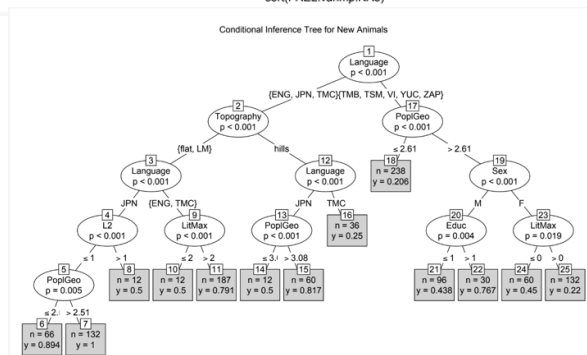
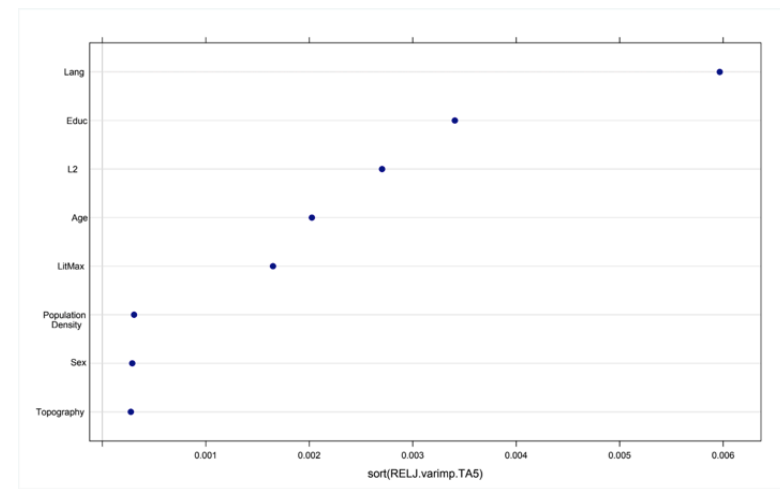
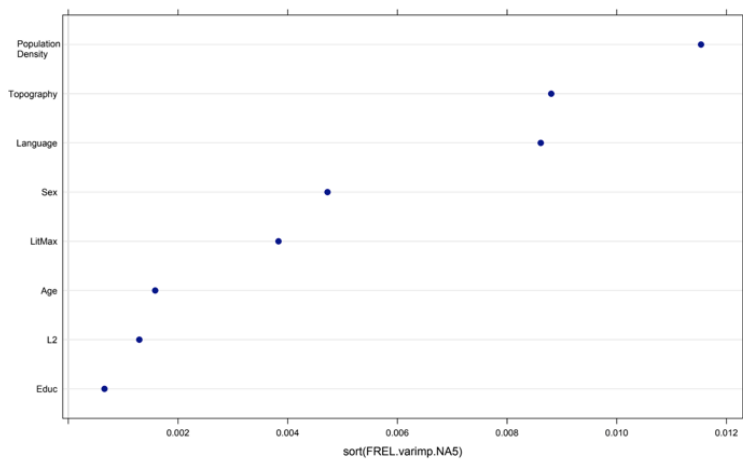

Figure 6.7. Random forest plots and conditional inference trees on recall memory data (left) and referential communication data from members of seven populations

► MesoSpace (cont.)

- these findings support a cultural evolution model of spatial cognition

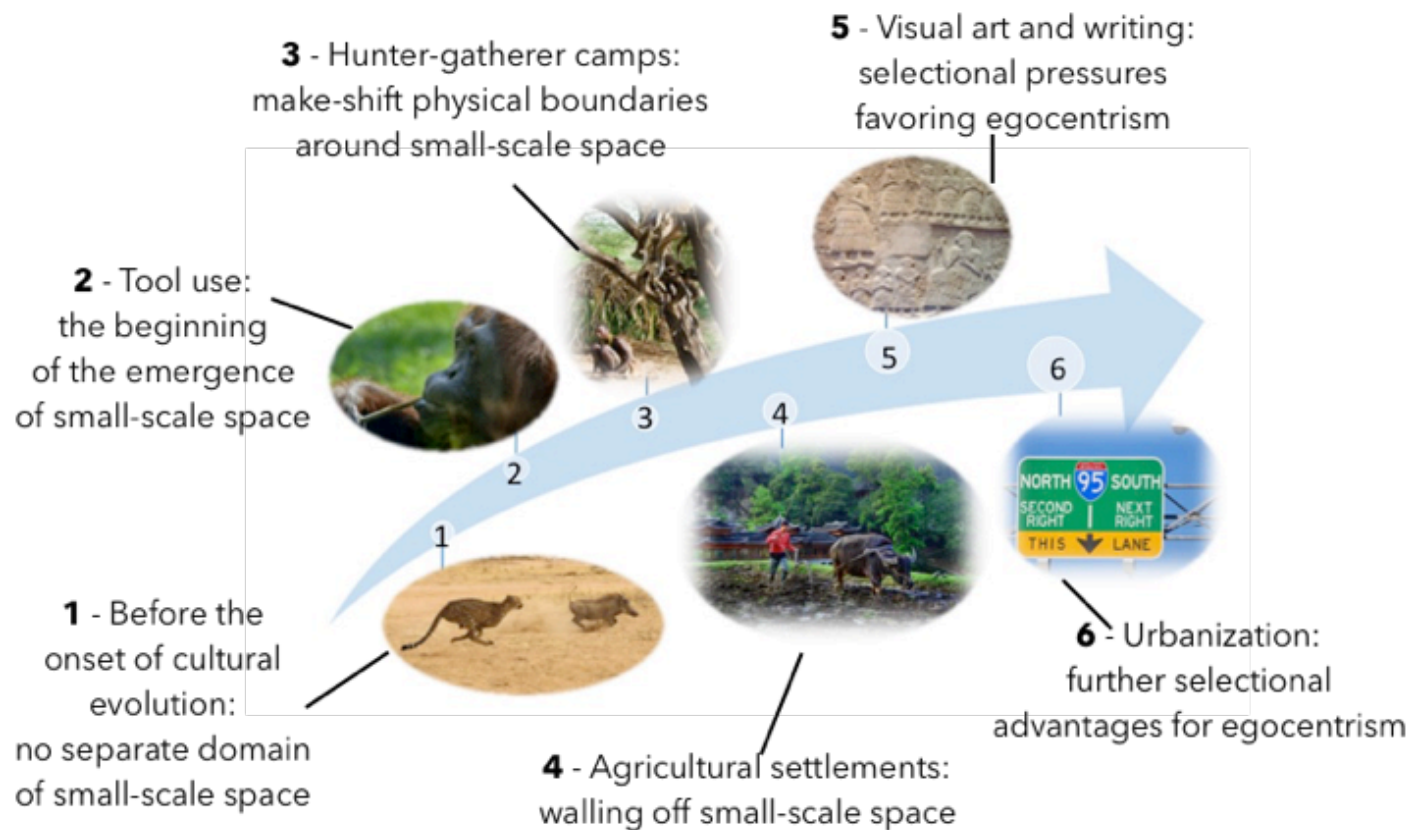

Figure 6.8. A stage model of the cultural evolution of spatial reference practices

- ▶ primary data collection is also prevalent in phonetic/phonological typology
- ▶ what about primary-data-based work in syntactic typology?
 - ▶ example: word order typology
 - ▶ in Yucatec discourse, both SV(O) and VS(O) are common
 - ▶ corpus and production studies would allow us to quantify their use
 - ▶ and compare it to data from other languages collected under comparable conditions (Dahl 2016)

ROADMAP

- ▶ The shoulders of giants
- ▶ The case for categorical particularism
- ▶ Some challenges of categorical particularism
- ▶ An ontology for categorical particularism
- ▶ Description, typology, and linguistic theory
- ▶ The future of typology (and linguistics)
- ▶ Epilog

EPILOG

- ▶ the observable amount of crosslinguistic variation renders categorical universalism difficult to support
- ▶ the notion of crosslinguistic prototypes seems untestable where it isn't backed by psychological evidence
- ▶ the composition of descriptive categories and comparative concepts out of universal property concepts ensures that
 - ▶ description and comparison/typology are mutually relevant
 - ▶ typological studies based on comparative concepts yield meaningful and valid generalizations

- ▶ the function of linguistic theory in descriptive and typological research
 - ▶ is to provide property concepts and comparative concepts and generate hypotheses
- ▶ large-scale crosslinguistic comparison is feasible in a way that large-scale cross-cultural comparison is not
- ▶ typology seems likely to increasingly shift from secondary to primary data
- ▶ a substantial part of my thinking about all this has changed during my time at UB
 - ▶ thanks to a very large extent to my colleagues here



ACKNOWLEDGMENTS

- ▶ many thanks to
 - ▶ Rui Chaves, Harald Hammarström, Jean-Pierre Koenig, Randy LaPolla, Sebastian Nordhoff, and Kilu von Prince
 - ▶ my partners in crime at CAL and MesoSpace
 - ▶ our sponsor, the National Science Foundation
 - ▶ grants BCS-153846 and BCS-1644657 (CAL); BCS-0723694 and BCS-1053123 (MesoSpace)
 - ▶ Matthew and Van,
for having gotten into my head pretty good 😎



Thanks!

